











ASSEMBLY INSTRUCTIONS

ITEM NO: F04

PARTS LIST:

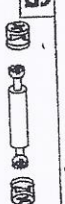
A		B		C		D		E		F	
	46 pcs		16 pcs		56 pcs		30 pcs		10 pcs		10 pcs
G		H		I		G		K		L	
	10 pcs		6 pcs		12 pcs		4 pcs				

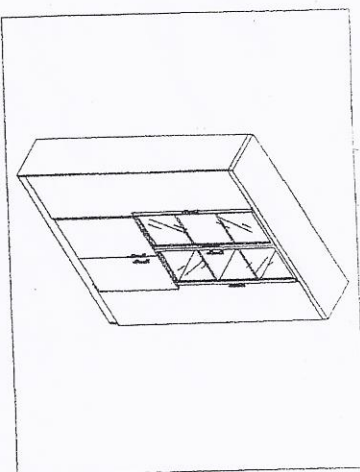

STEP 3:

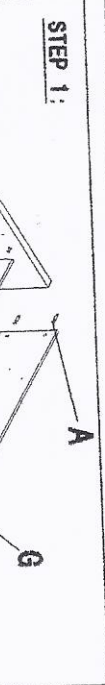
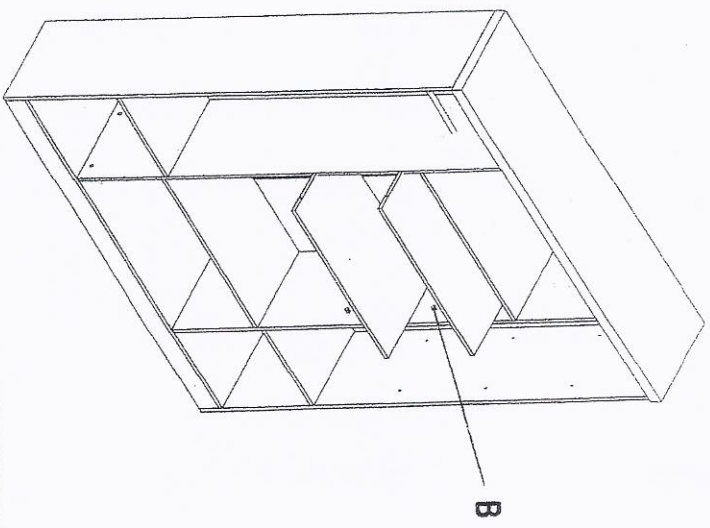

STEP 1:

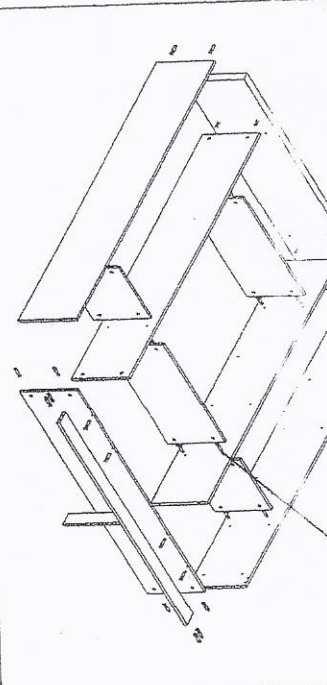

STEP 2:

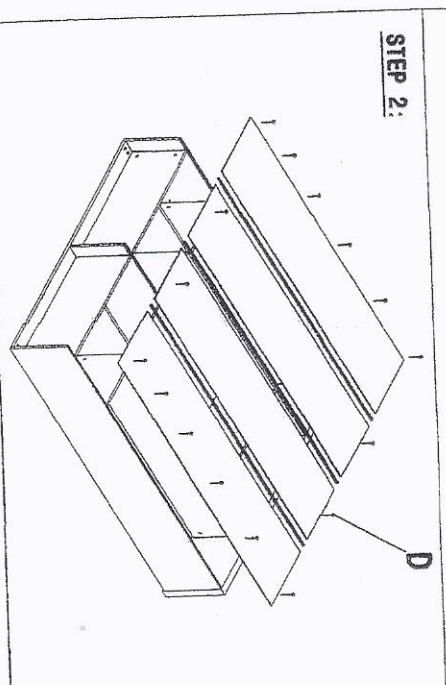

STEP 4:

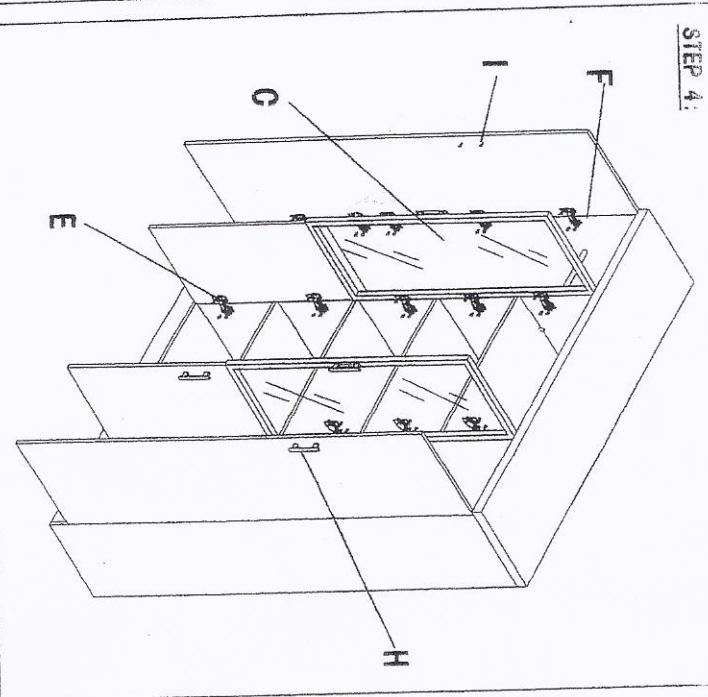

RESOLVE VIEW

