

Item No.:CH101

Installation guide

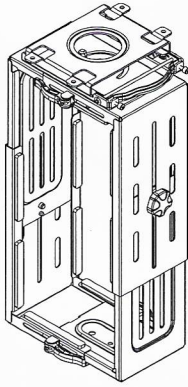

Mounting panel (1PC)

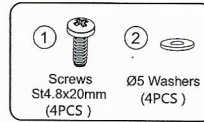

Host Bracket (1PC)

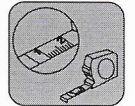
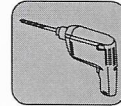
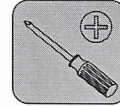

STEP 1

Install the mounting panel to the desk

1 Mark the location of the four screw holes under the desk

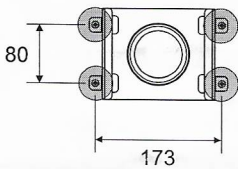

2

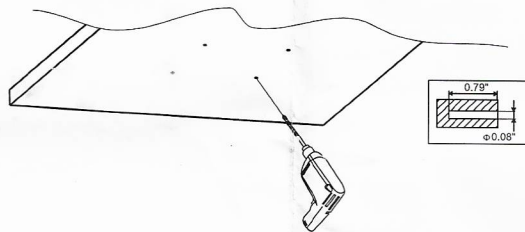

3

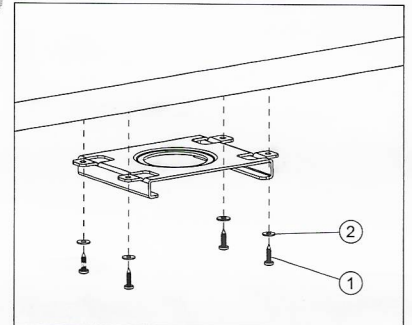

Note: Please install the bracket under the desk at the location you've chosen and remain the space for the host.

Drill pilot holes where the four marks are located with an impact drill

Install the mounting panel with four screws ① and four washers ②.

STEP 2

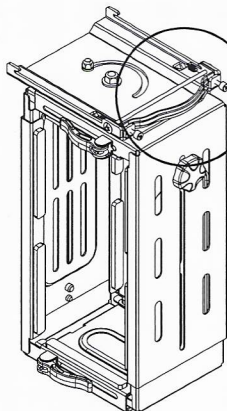

Rotate the screws out a little for installation

STEP3

Install the host

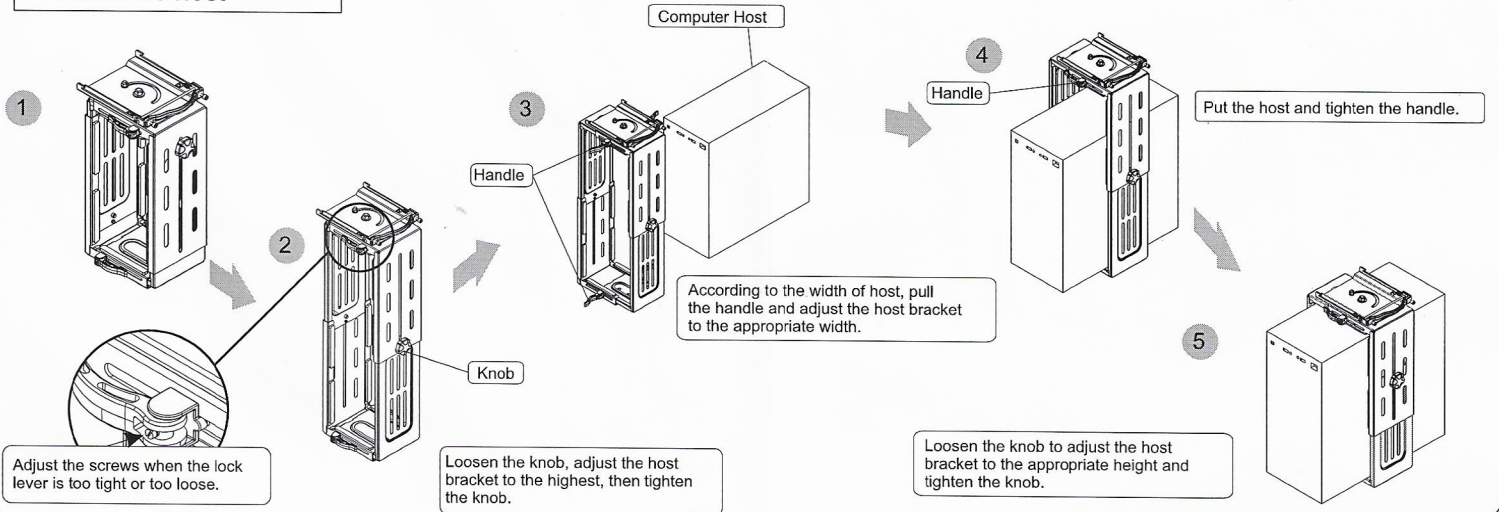

STEP4

Install the host

Fix one side of the host bracket on the mounting panel and pull out the handle to lock the other side.

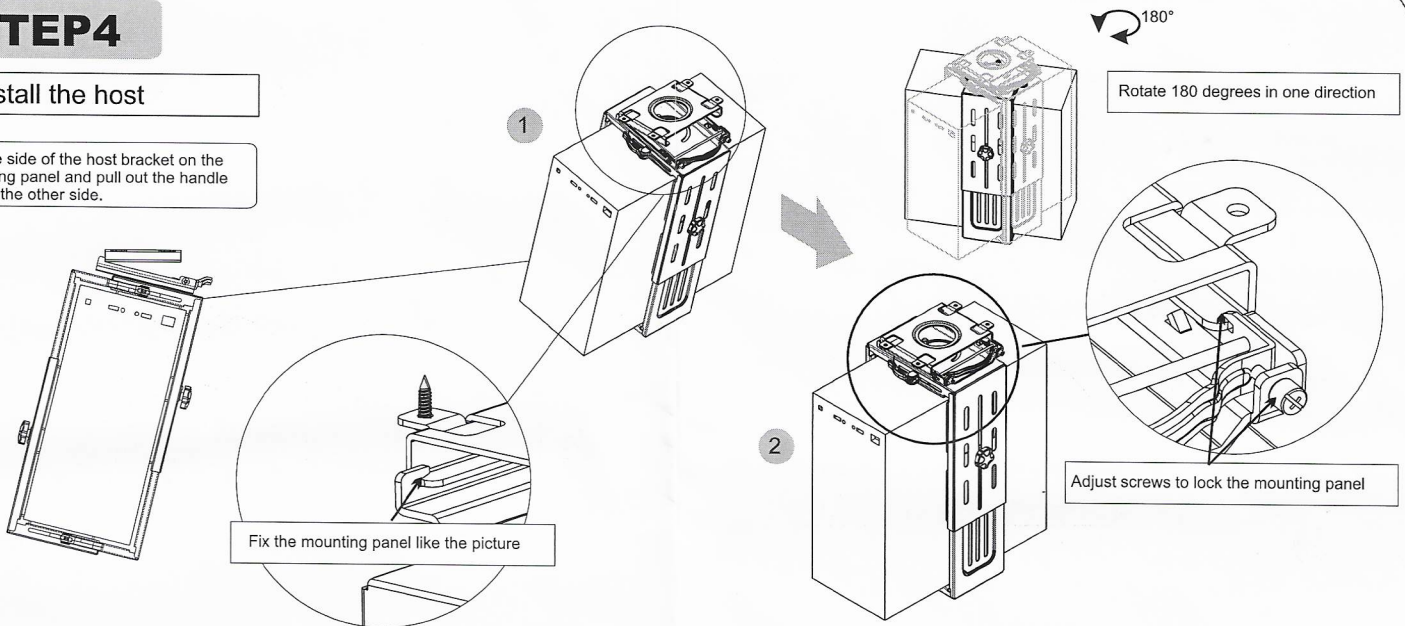

CAUTION

This product contains small items that could be a choking hazard if swallowed. Keep these items away from young children.

- Make sure these instructions are read and completely understood before attempting installation. If you are unsure of any part of this installation, please contact a professional installer for assistance.
- Please check joint parts every two months, making sure the screws are loosened or not.
- Never exceed the maximum load capacity 15 KG, or else it may result in product failure or personal injury.

Note: this product is intended for indoor use only. Use of this product outdoors could lead to product failure or personal injury.