



A	 $\phi 8 \times 32$ x41
B	 ($\phi 15$) x41
C	 ($\phi 8 \times 40$) x2
D	 ($\phi 3.5 \times 14$) x20
E	 x2
F	 (350mm) x1
G	 x2
H	
I	
J	
K	
L	
M	
N	
O	
P	
Q	

Gastein
BLG600-C
main cabinet



1

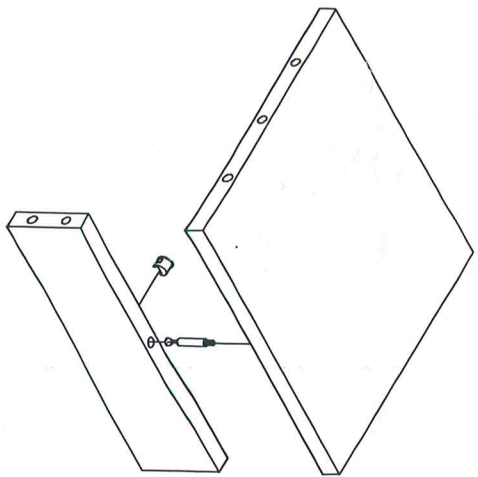
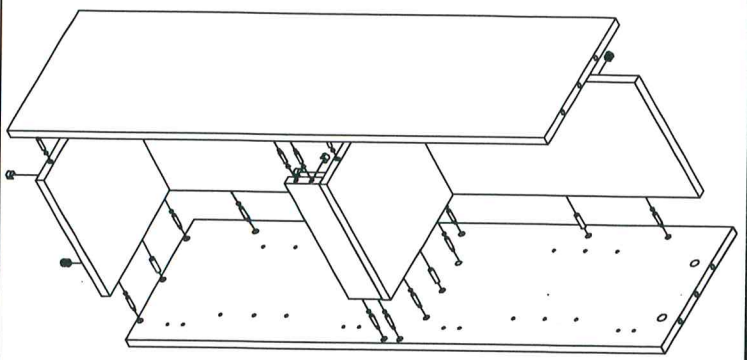

2

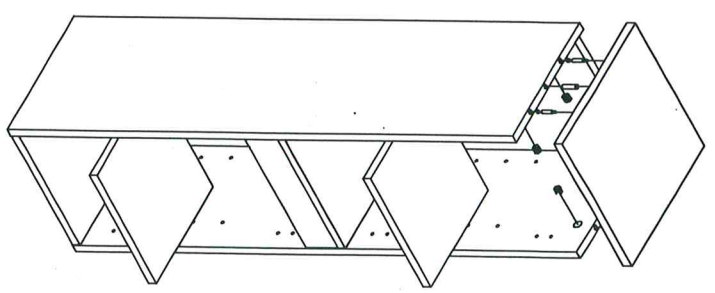



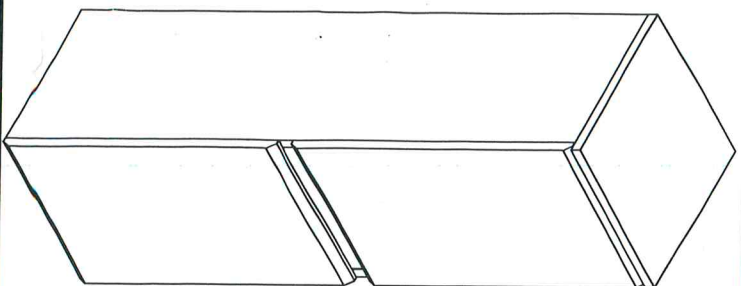



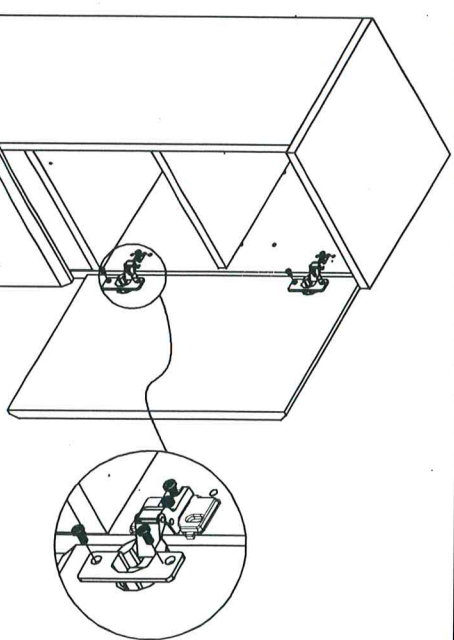

3



5



4

A		(ϕ 8x32)	x23
B		(ϕ 15)	x23
C		(ϕ 8x40)	x10
D			x4
E			x2
F		(4x16)	x6
G		(3.5x14)	x24
H			x8
I			x16
J			
K			
L			
M			
N			
O			
P			
Q			

Aiger
BLG1100-S
Side Cabinet