

TR--019 Intellect Steam Generator

Operation

Manual

CAUTION

The power outlet using for this steam generator must have a earthed cable and an electric shock protection, and make sure them is availability.

The personnel who install this steam generator must be qualified professional.

AC Supply Voltage: 220V-240V

Water Supply: 0.1-0.4Mpa .

The AC supply using for steam house must be separateness, the cross-section of the power cable must exceed 2.5mm, and with a separate power switch.

Must turn off the power supply after finish using the steam generator

Must cut off the water supply after finish using the steam generator

A.TR--019 Steam Generator control panel

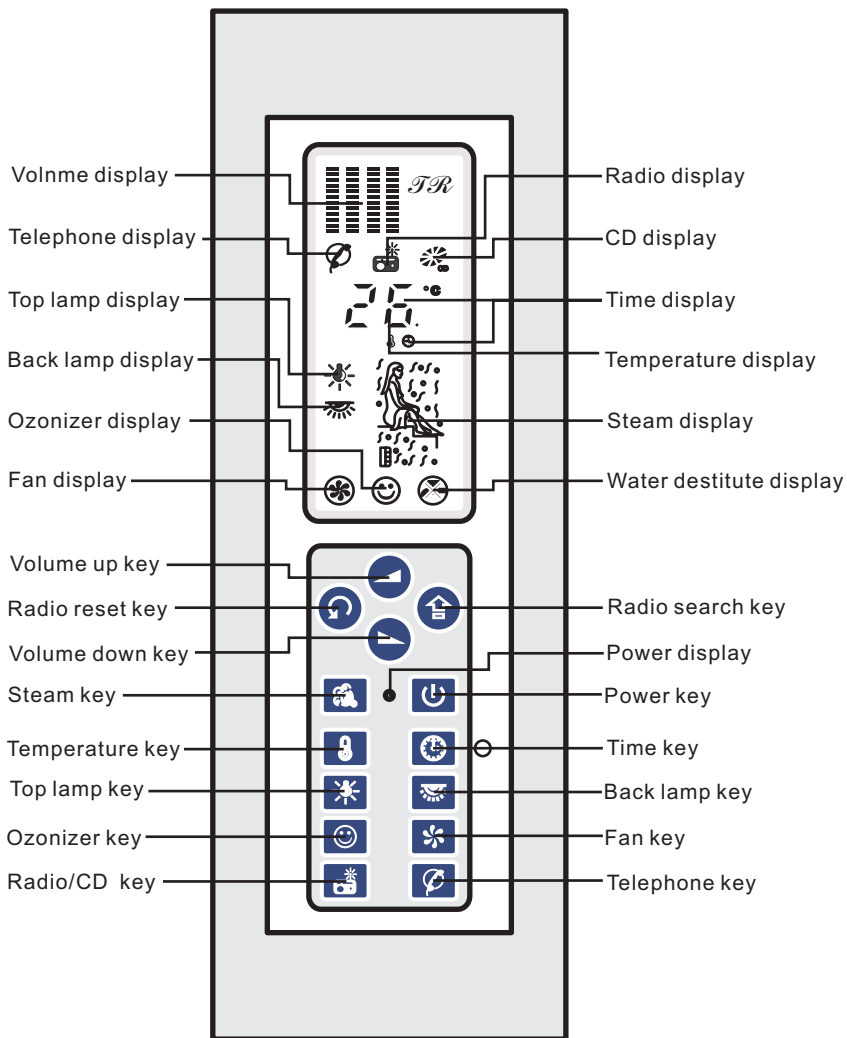



B. TR-019 Steam generator Operation manual

1、 Please open the water supply valve before push  " power" key to turn on the power , the LED lamp will be light after turn on the power, then the steam generator is ready for working ,the window of temperature display the present temperature.



2、 Temperature setting : Push  " TEMPERATURE "key, the temperature display will flash , and the predestine temperature is display. The predestine temperature limit to :20~ 60 °C . Push the key after 3 second, the temperature continuously up. After set the temperature your need, the temperature display stop flash after 3 second later, the user-defined temperature stored in computer REM automatically and the temperature window display the actual temperature of bathroom. The steam generator will stop working when the temperature of bathroom is higher than or equal to the user-defined temperature, when the temperature of bathroom is lower than the



user-defined temperature for 30 second, the steam generator will work again. The default temperature is 45 c.(Note : Because of the temperature detector inside operating box, the temperature for display may be less than the temperature of bathroom)



3, Time setting : Push  " TIME " key to set up time, the time step two minute for every push, the time limit to: 0 ~60 min .When the time is lower than or equal to " 00 ", the steam generator stop working ,if you need steam continue, you must reset time again and push  " STEAM " key . As if you need steam generator working without time limit, set time to " 00 " directly . On operating, you can reset time at anytime.



4, Be sure water supply is appropriate, then push  " STEAM " key, steam display light, the steam spray out after 3 minute .If the water is destitute , the water destitute display and the steam display flash ,the steam generator stop working impermanent still the water supply is appropriate .please find out the trouble of water supply before using



steam generator . On operating, you can push  "STEAM" key again to stop the steam generator working.

5, Push  " FAN" key, fan display light, the fan working, you can push  " FAN " key again to stop fun working .

6, Push  " OZONIZER" key, the Ozonizer working, you can push  " OZONIZER " key again to stop Ozonizer working .



7, Push  " TOP LAMP " key, top lamp display light, the top lamp working. you can push  " TOP LAMP "key again to stop the top lamp working.



9, Push  "BACK LAMP " key, back lamp display light, the top lamp working. you can push  "BACK LAMP "key again to stop the back lamp working.



10, Push  " RADIO/CD " key, radio display light, the radio working . Push  " RADIO/CD "key Again, radio display dark, radio turn off .



On radio: (Frequency range : FM87.5 ~ 108 MHz) push



 "SEARCH "key , the radio searching broadcast from

87.5MHz up to 108MHz automatically .When get a broadcast, the radio can self-lock the broadcast, push  "SEARCH "key again the radio automatic search for next broadcast .As if frequency arrive 108MHz, push  "RESET "key to reset the frequency to 87.5MHz, then push  "SEARCH "key again to search broadcast automatically .

9、 Push  "RADIO/ C D "key, CD display light , the CD working, push  "RADIO/ C D "key again, CD display dark, CD turn off .

10、 When have a calling, telephone buzzer ring, then push  " TELEPHONE" key, telephone display light, the telephone working and cut off the Radio or CD automatically .Push  " TELEPHONE" key Again , telephone display dark, telephone turn off .

11、 Volume setting : Push  " volume up " or  " volume down " key to set up volume, push the key after 3 second later, the volume continuously up or down..

12, Finish washing, push  "POWER" key to turn off the steam generator. At this time, the LED display screen display count down for 60 second, the steam generator automatic drain, turn on Fan, automatic turn off the Steam, Light, Radio, CD and Telephone . The steam generator will standing again after 60 second. You can push  "POWER" key to restart the steam generator.

13, Finish using the steam generator, please turn off the power and cut off the water supply.

ELECTRICAL SPECIFICATIONS :

Supply Power	Alternating current 220V-240V
Power Frequency	50Hz/60Hz
Control Voltage	Direct current 12V
Limit Power	3KW
Light Voltage	Alternating Current 12V
Fan Voltage	Direct current 12V
Radio Output Power	5W

WATER SUPPLY INSTALL:

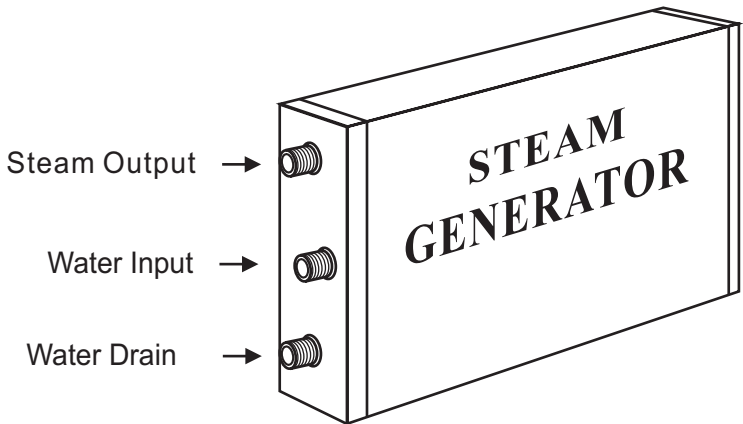

Steam engine

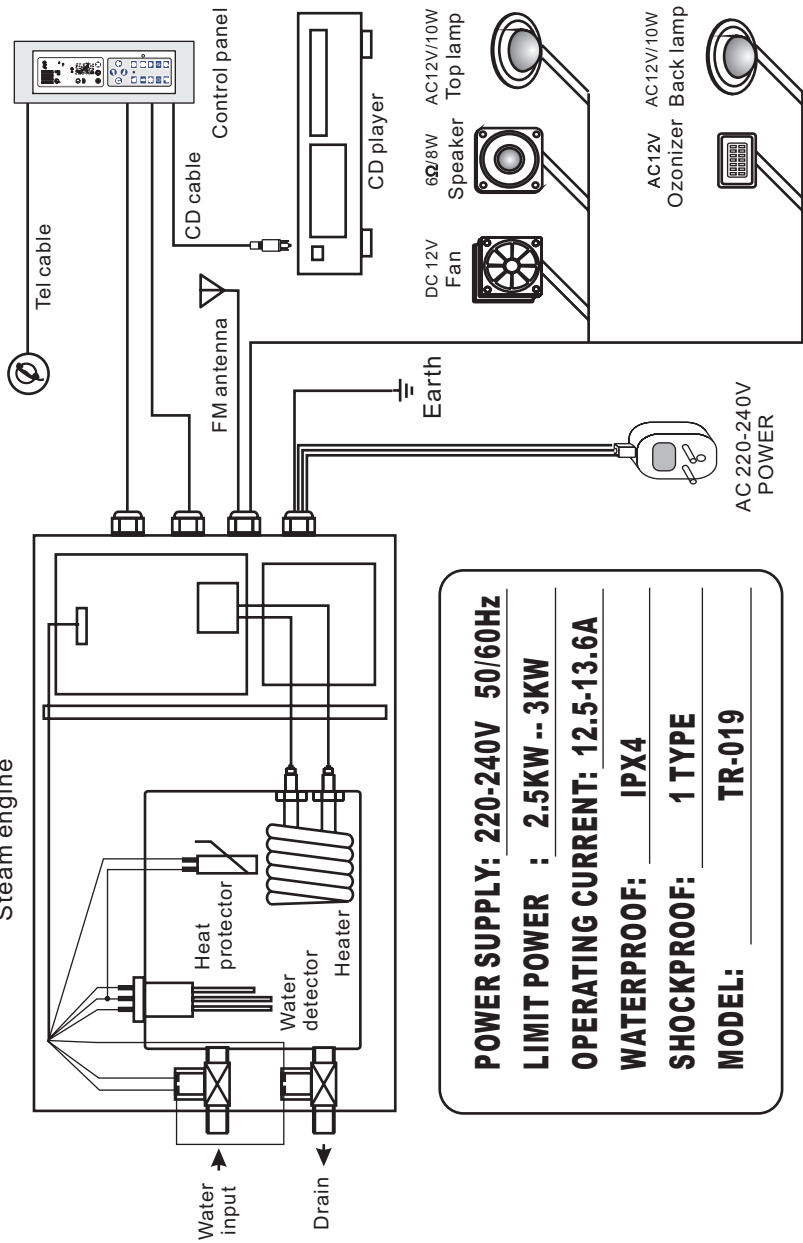

POWER SUPPLY: 220-240V 50/60Hz

LIMIT POWER : 2.5KW --3KW

OPERATING CURRENT: 12.5-13.6A

WATERPROOF: IPX4

SHOCKPROOF: 1 TYPE

MODEL: TR-019

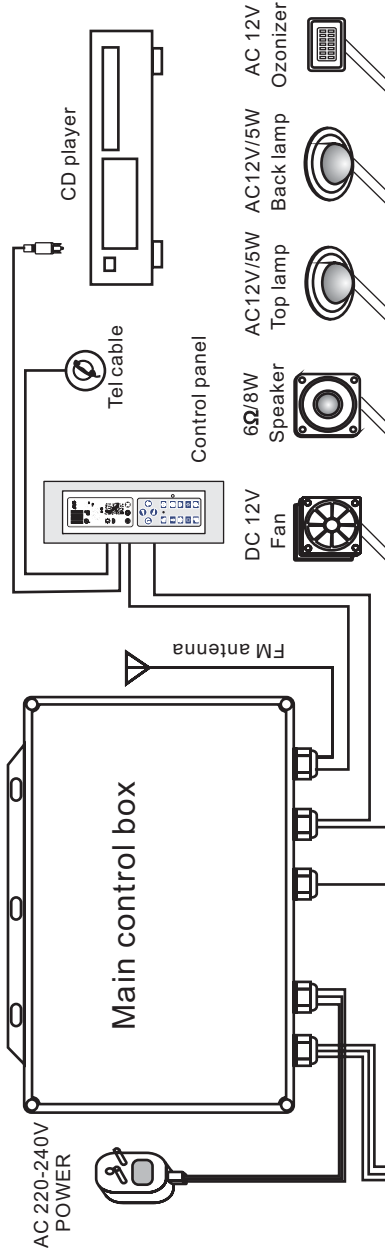

POWER SUPPLY: 220-240V 50/60Hz

LIMIT POWER : 2.5KW-3KW

OPERATING CURRENT: 12.5-13.6A

WATERPROOF: IPX4

SHOCKPROOF: 1 TYPE

MODEL: TR-019

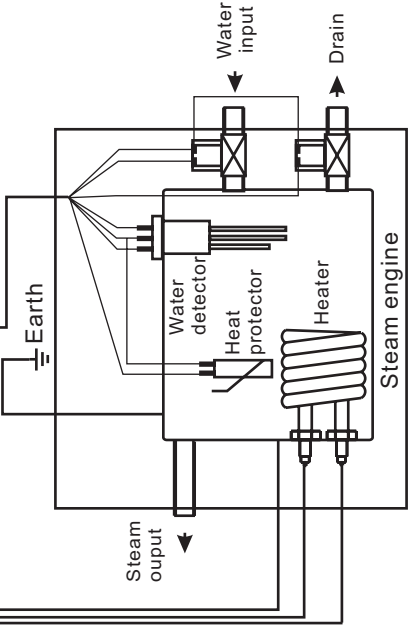

STEAM GENERATOR SCHEMATIC

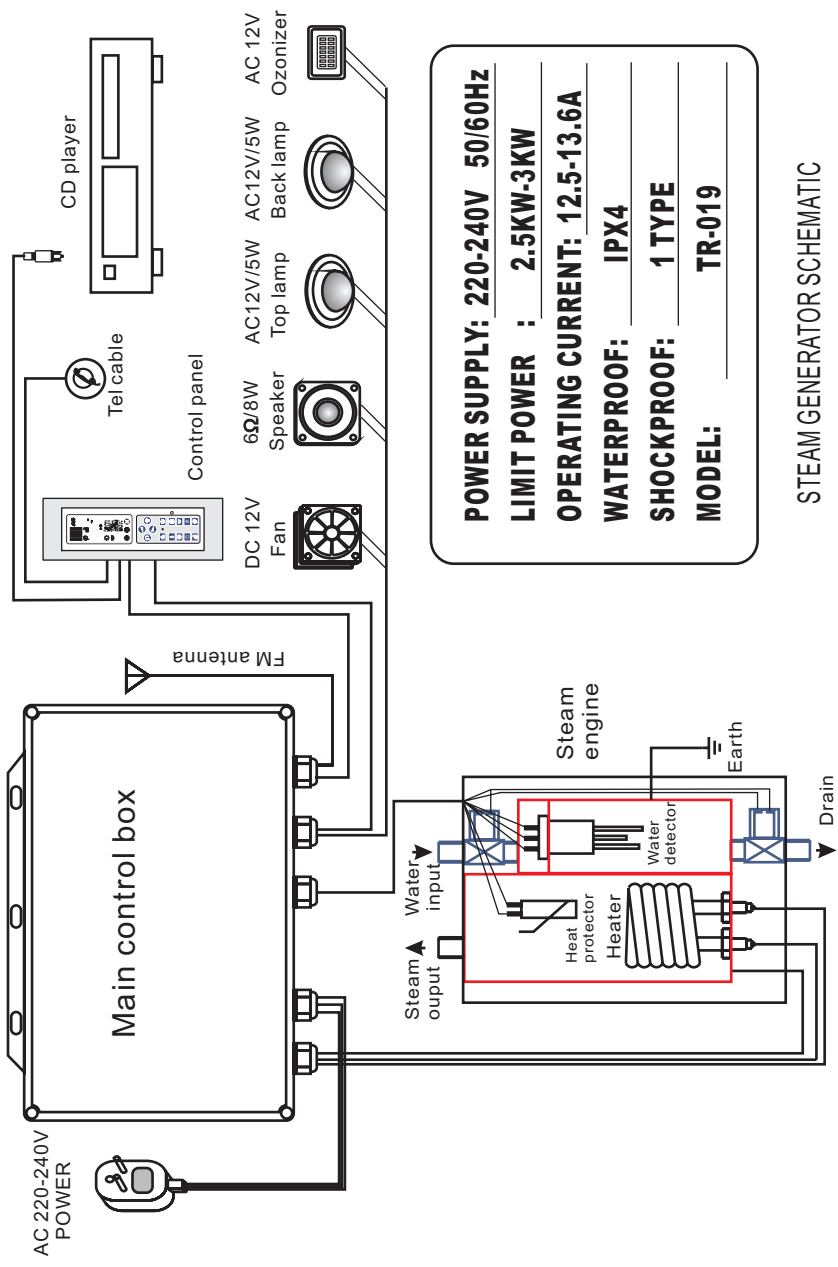

POWER SUPPLY: 220-240V 50/60HZ
LIMIT POWER : 2.5KW-3KW
OPERATING CURRENT: 12.5-13.6A
WATERPROOF: IPX4
SHOCKPROOF: 1 TYPE
MODEL: TR-019

STEAM GENERATOR SCHEMATIC