

Instruction Manual

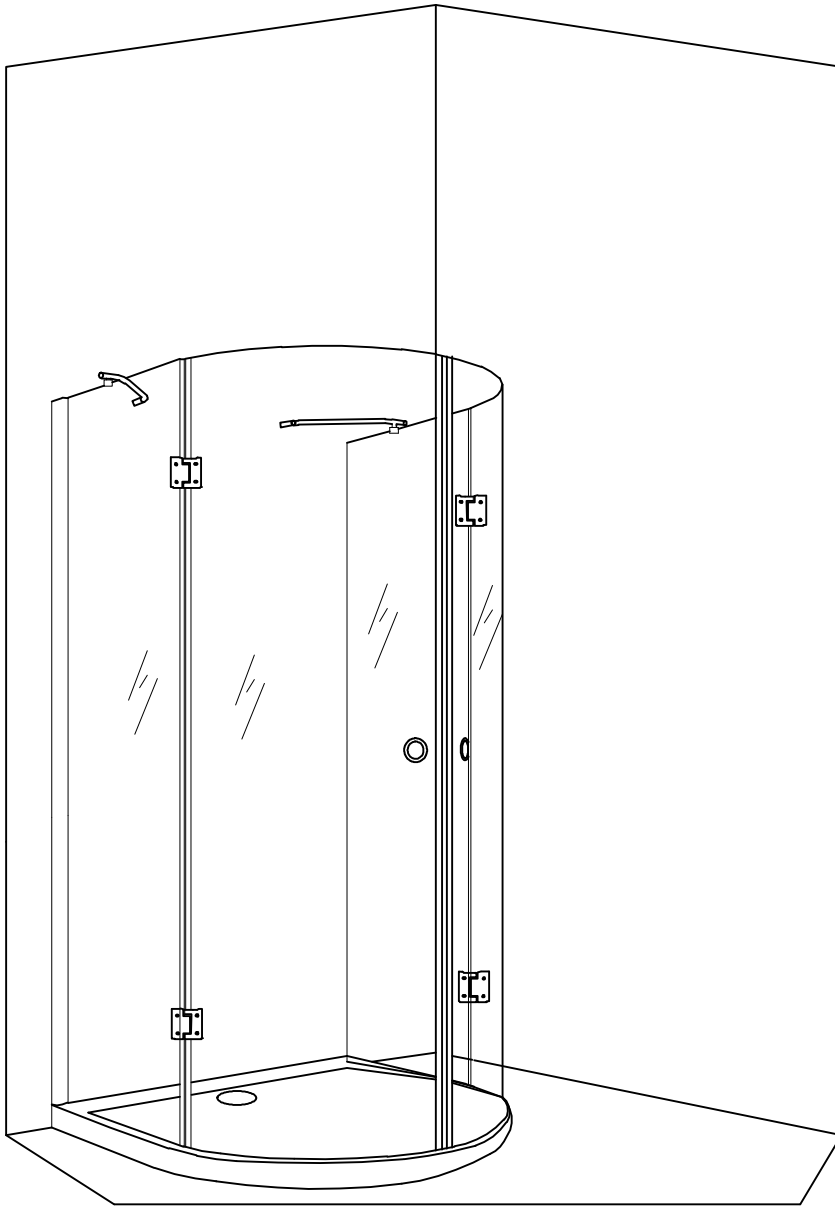

MODEL: SR-NR1002

SIZE: 100*100*190cm

MODEL: SR-NR0905

SIZE: 90*90*190cm

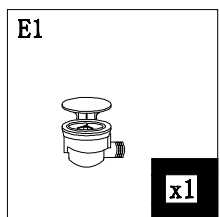
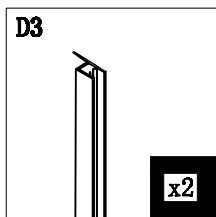
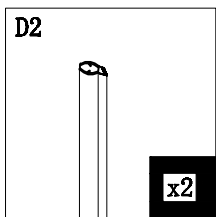
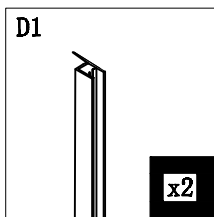
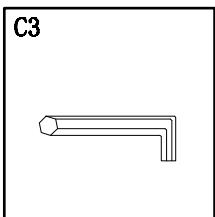
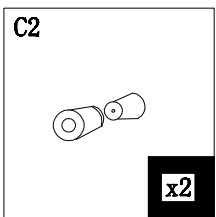
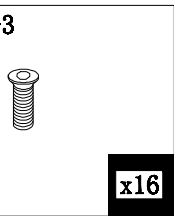
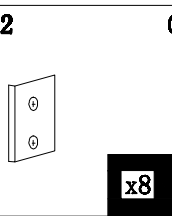
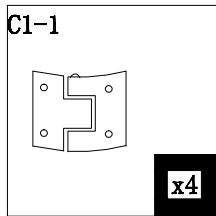
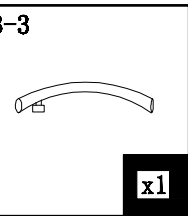
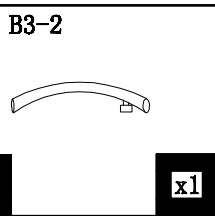
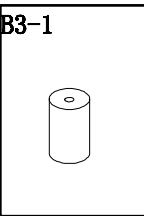
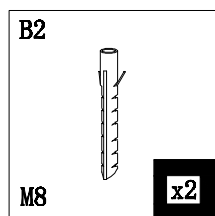
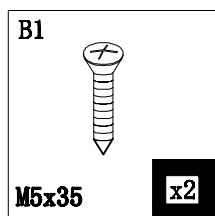
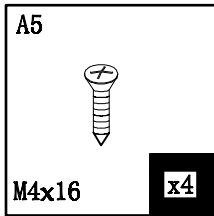
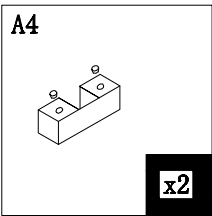
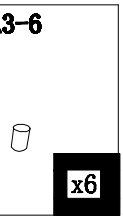
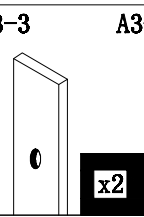
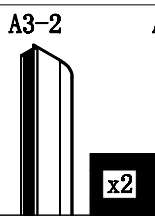
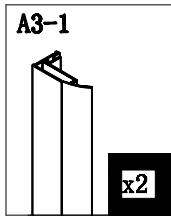
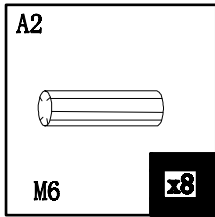
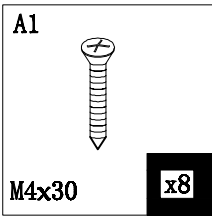
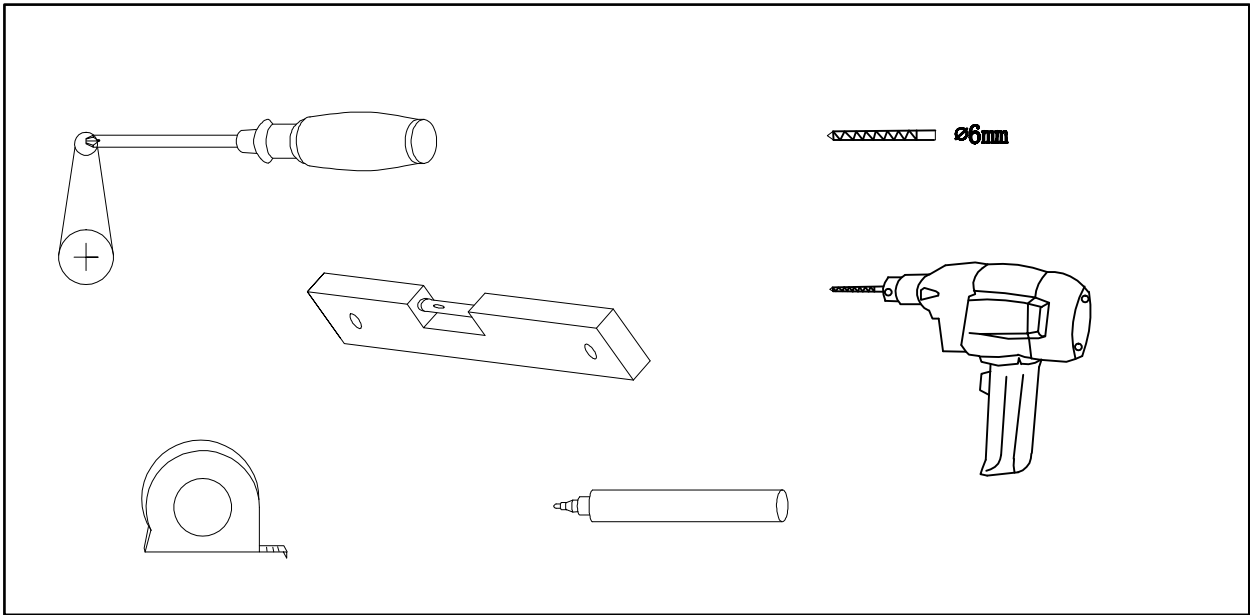

E1



x1

