

## ASSEMBLY AND DISASSEMBLY

**ATTENTION :** DO NOT use a compressed air source (i.e. automotive tire air compressor) to inflate boat.

Overinflation through the use of compressed air may result in ruptured seams and/or bulgeheads.

### ASSEMBLY

1. Remove any sharp objects from the area where boat will be assembled and inflated.
2. Unfold and spread boat out flat.
3. Attach the valves in their proper place. Check that the cap gasket is in place. Attach valve retainer to each valve.

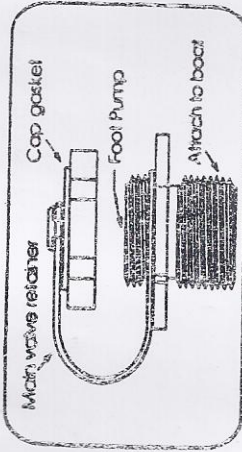

Valve Assembly

2

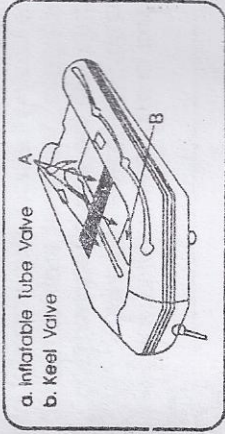

Location of Valves

4. When using the boat for the first time, fully inflate boat by attaching foot pump to each of the valves, one at a time, and pump air to maintain a balance of pressure between chambers until fully inflated. When the boat is fully inflated, unscrew valves and allow approximately 1/2 of the air to escape. Screw in valves, and continue with assembly.

**NOTE :** Do not inflate keel until floor boards are installed.

5. If boat has been previously inflated, attach foot pump to each valve, one at a time, and add air to each chamber to 1/2 the capacity of each chamber.

3

## ASSEMBLY FOR SS 230,250,270

Before inflating the boat, slide each slit into a fabric sleeve. The boat can be rolled up with the slats in place, but remove them when cleaning out sand, or small stones.

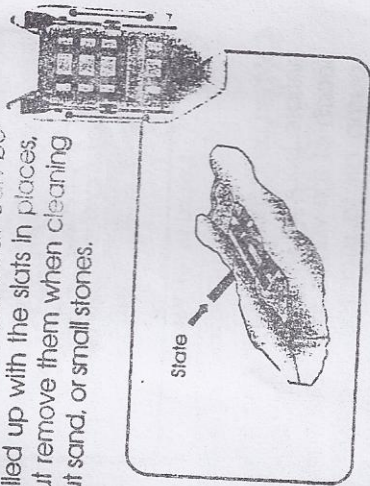

## FLOOR AND "H" JOINT ASSEMBLY FOR 230,265,300

NOTE: When installing floor boards, identifying numbers of boards must face up.

1. Insert #1 floor board in bow of boat and attach "H" Joint.

NOTE: Each "H" Joint should be installed with larger flat side facing up.

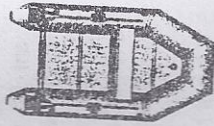

2. Insert #3 floor board into transom of the boat.
3. Insert #2 floor board into "H" Joint attached to #1 floor board.
4. Insert "H" Joint between #2 and #3. Press floor board until flat.

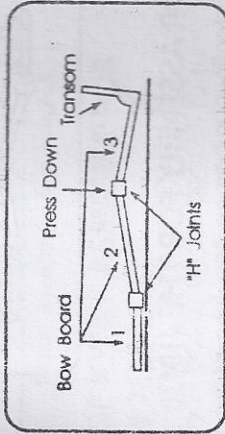

Floor Assembly for 230,265,300

## FLOOR ASSEMBLY FOR THE 330,360,380

NOTE: Identify numbers on floor boards face up.

1. Insert #1 floor board in the bow of boat.
2. Insert #4 floor board in transom of the boat.
3. Insert #2 floor board into #1 floor board.

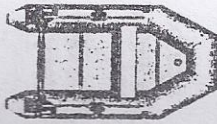

4. Insert #3 floor board into #2 and #4 floor boards and press down until flat.

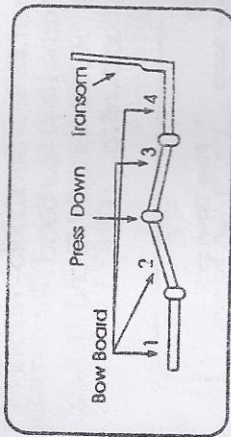

330,360,380

### Ⓞ FLOOR ASSEMBLY FOR THE 410430

NOTE: Identify numbers on floor boards face up.

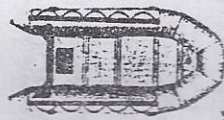

1. Insert #1 and #2 can be made as one set.
2. Insert #5 floor board in transom of the boat.
3. Insert #3 floor board into #2 floor board.
4. Insert #4 floor board into #3 and #5 floor boards and press down.

6

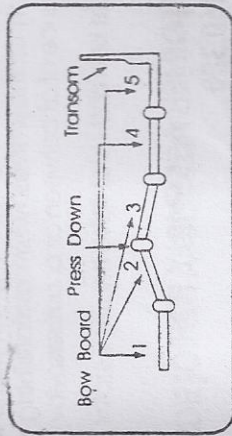

Floor Assembly for 230,265

### Ⓞ SIDE JOINER ASSEMBLY FOR 230,265,300

1. Slide oar (a) under bottom to raise floor boards (b) from surface. Attach side joiners (c). Repeat procedure on opposite side of boat.

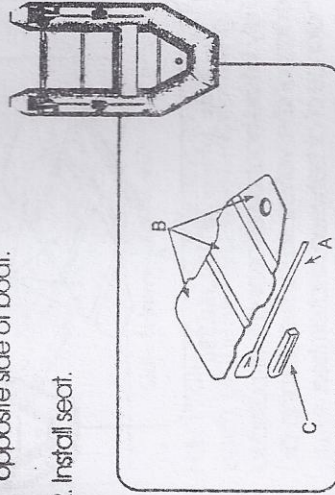

2. Install seat.

Side Joiners of 230,265,300

7

3. Fully inflate boat by attaching foot pump to each of the valves, while maintaining a balance of air between air chambers.

4. Inflate keel and install valve caps.

### **☉ SIDE JOINER ASSEMBLY FOR 330,360,380**

1. Slide oar(a) under bottom of boat to raise floor boards(b) from flat surface. Attach side joiners(c). Repeat procedure on opposite side of boat.

2. Install seat.

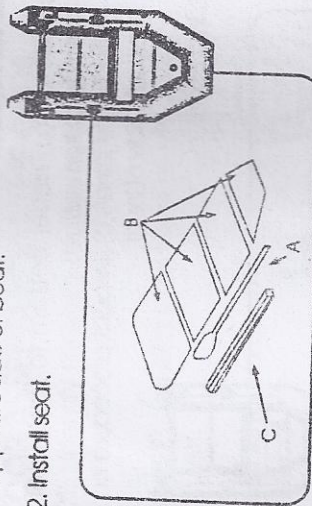

**Side Joiners of 330,360,380**

3. Fully inflate boat by attaching foot pump to each of the valves, while maintaining a balance of air between air chambers.

DO NOT inflate any chamber to full capacity at one time. Install valve caps.

4. Inflate keel and install valve caps.

### **☉ SIDE JOINER ASSEMBLY FOR 410,430**

1. Slide oar(a) under bottom of boat to raise floor boards(b) from flat surface. Attach side joiners(c). Repeat procedure on opposite side of boat.

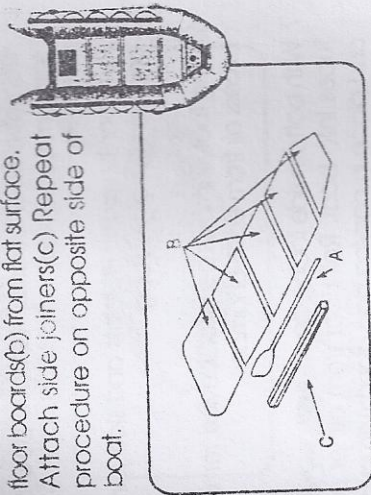

**Side Joiners of 410,430**

2. Fully inflate boat by attaching foot pump to each of the valves, while maintaining a balance of air between air chambers. DO NOT inflate any chamber to full capacity at one time. Install valve caps.

3. Inflate keel and install valve caps.

## DISASSEMBLY

1. Unscrew all air valves to deflate boat.
2. Remove seat.
3. Remove side joiners from floor boards.
4. Raise the middle floor and detach from "H" Joints (230,265,300). Remove floor boards. Remove bow and transom boards last.
5. Put floor boards, "H" Joints and side joiners and oars in carrying bag.
6. Using foot pump as a suction device, remove excess air from each chamber.
7. With bottom side facing down, tuck gunwale tubes into boat. Roll boat from either end and place in carrying bag along with pump and hose.

10

## RIB BOAT ASSEMBLY AND DISASSEMBLY

### ASSEMBLY

1. Take out the rigid hull and unfold and spread the tube for assembly.
2. Inflate the tube for securing the rigid hull.
3. Attach the seat, oar etc.



### DISASSEMBLY

1. Deflate the tube
2. Fold the tube and put it with the pump, oar etc. into the boat.

### CLEANING PROCEDURES

All fabrics can be cleaned with soap and water.

**IMPORTANT: DO NOT** use a vinyl preserving agent on fabric surfaces. Chemicals in such agents will dry out the fabric.

11

## OPERATION INFORMATION

### SAFETY

It is the responsibility of the operator of the boat to know all laws applicable to the boat and to comply with those laws in equipping and operating the boat.

The applicable laws rules and regulations may vary.

Factors which might affect the applicable rules and regulations include the following: the place of operation and the requirements of local authorities; the use of the boat; the time of day; the conditions under which the boat is being operated; and the size, speed, course, type of boat (power, oars, etc) and model of operation.

In conjunction with knowing and following the applicable laws, please refrain from the following.

1. Each occupant of the boat should wear the appropriate clothing and have access to an approved life-jacket or personal flotation device.

2. Ensure that all basic equipment is on board the boat including paddles/oars and inflation pump. Be aware of the possible necessity of additional safety equipment.

3. A boat should not be operated by an individual while under the influence of drugs or alcohol.

4. Weight must be distributed evenly. If lightly loaded and your boat is equipped with a motor do not accelerate suddenly. Stability and handling problems can occur if the operator mishandles the craft.

5. The carrying capacity and the engine capacity for the boat must not be exceeded.

6. Outboard motors are dangerous and can cause injury and death when improperly operated. Never equip or operate out boat with a motor that is not approved for use with the boat. Be cautious of swimmers of high speeds. Do not allow a swimmer to approach the stern of the boat while the engine is running.

7. Attention should be given to winds and tides, their changes and their effect on fuel consumption.

8. When boating in unknown water it is always wise precaution to obtain local knowledge of the waterways before setting out.

9. Always tell someone your time and place of departure. Proposed route and time you expect to return.

10. The display of navigation lights may be required. The user should ensure that a boat should not be operated during darkness or other hazardous weather conditions unless the correct navigation lighting has been fitted and is operating properly.

11. Safety courses on boat handling are available in most countries from national or local organizations. Operators should make themselves aware of the general rules of the waterways and local water conditions before taking a boat out.

12. On extended voyages proper consideration must be given to safety equipment such as flares, first aid-kit, anchors, etc.

## PROTECT THE ENVIRONMENT

Please take into consideration in keeping the environment clean by properly disposing of oil due to fuel leakage, dirt, and other water wastes that can result from operating boats.

Consideration should also be taken in the proper disposal of residues e.g. Paint, paint removed substances and other cleaning agents.

## INFLATION - DEFLATTON

1. Inflate boat with the supplied foot pump.

NOTE : When using the foot pump, the boat should not be overinflated. If using an electric inflator, finish the inflation procedure with the foot pump supplied, and obtain the correct inflation pressure.

2. The maximum inflation pressure is 0.25 bar for the boat and 0.35 bar for the keel. Depending on climate and operating conditions, the pressure may require monitoring during boat use to insure that correct inflation is maintained.

3. A boat inflated for 2 to 3 days may lose pressure and may require reinflation to correct operating pressure.

**WARNING :** DO NOT use a compressed air source (i.e., automotive tire air compressor) to inflate boat.

Overinflation may result in ruptured seams and/or bulkheads.

4. When inflating or deflating, maintain a balance of air between air chambers to prevent damage to air chamber bulkheads.

## **LOADING**

1. DO NOT EXCEED THE WEIGHT CARRYING CAPACITY AS INDICATED ON THE BOATS IDENTIFICATION PLATE.

2. Each person in the boat should wear a life jacket (personal flotation device).

3. Oars or paddles, and a repair kit should be carried on board for emergencies.

4. All loads placed in the boat should be distributed uniformly to provide proper boat trim when operating.

## **OPERATION : ROWING**

1. Inflatable boat comes standard with oars, thole-pins and rowing seat, in sure seat is properly installed.

2. Install oars in thole-pins attach thole-pin cap screws.

**NOTE :** DO NOT use oars as levers; they are breakable!

3. Local water conditions must be taken into account before operating boat with oars or a small outboard motor. Boat power may not be strong enough to overcome currents in tidal inlets, open seas, small channels or shallow water regions.

## **OPERATION : OUTBOARD MOTOR**

### **WARNING**

**DO NOT OVERPOWER!** Overpowering can result in severe handling and/or stability problems.

**USE AN EMERGENCY SWITCH** with a lanyard.

This switch will stop the engine if, for any reason, the operator pulls the cord.



When operating the boat every one should be seated on the floor.  
NOT on the side tubes or the rowing seat, in order to prevent falling overboard.

When operating the motor powered boat alone, do not sit on the side or on the row seat, but as far forward as possible.

Rapid acceleration should be avoided to prevent falling overboard.

1. Regular checks should be made on motor attachment screws.  
Loose screws will cause erratic boat operation and possibly the loss of your outboard motor!

2. Read the manual carefully before assembling or operating the boat.

3. On board loads should be monitored to avoid chaffing or puncturing of boat skin.

### ADJUSTING THE TILT OF THE MOTOR

1. If the motor is positively trimmed, the boat will porpoise.

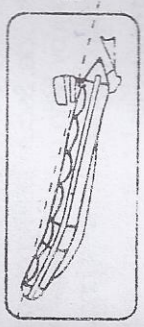

2. If the motor is negatively trimmed, the boat will nose down.

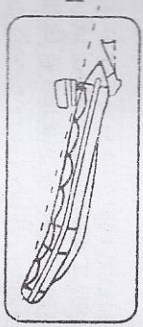

### TOWING - ANCHORING - MOORING

1. If the inflatable boat is towed by another boat, the inflatable MUST BE EMPTY of passengers.

The towing line should be secured to the "D" rings on each side of the inflatable. The towed inflatable must be observed continuously.

2. Anchoring and mooring lines should be secured to the bow "D" ring.

### **⊙ AIR - CHAMBER FAILURE**

1. Should an air chamber fail, shift the weight to the opposite side. Secure leaking chamber as necessary (by tying or holding up) and immediately proceed to the nearest land.

### **⊙ WATER HAZARDS**

1. Wrecks, reefs, rocky shores, sand bars, and shallows should be avoided or approached with caution.
2. When boating in unfamiliar waters, obtain information on local water hazards before launching.

### **⊙ BEACHING**

1. It is recommended that the boat NOT be powered onto the beach, dragged across rocks, sand or pavement as damage to the boat skin may result.
2. If the boat is to be temporarily left on a beach, a portion of the boat should be left in the water to dissipate internal heat caused by exposure to sunlight that will increase air pressure.

20

3. Cover the boat to block direct exposure to sunlight if the boat is to be removed from the water for an extended period of time.

### **⊙ STORAGE**

1. After use, the boat and all components should be washed with a mild soap and rinsed with fresh water.  
Dry all parts before storage in the carrying bag. This will help prevent mould or mildew.
2. Wooden components should be inspected for damage or deterioration to the finish. Surface scratches or abrasions should be refinished with a marine grade varnish.
3. To keep the boat looking new, store the boat in a cool and dry space and avoid excessive exposure to direct sunlight.  
**IMPORTANT.** Waxes or cleaners containing alcohol **SHOULD NOT** be used on the boat fabric.  
Alcohol will prematurely dry out the boat fabric.
4. To avoid damaging the boat during storage, do not place heavy objects on boat.

21

## USE IN HIGHER ALTITUDE

1. Normal full inflation pressure is 0.25bar for the tube and 0.3bar for the keel. If boat is inflated at sea level (low altitude) and transported to a high altitude (ie. for use in a mountain lake), the air pressure must be reduced at the higher altitude to prevent overinflation.

## REPAIR PROCEDURE

### SMALL TEARS, CUTS and PUNCTURE

1. The repair of a small leak or puncture less than 1/2inch(12.7mm) can be done with a round patch, 3inches(76.2mm) diameter, minimum.
2. Both patch and surface on boat must be dry and free of draft and grease.
3. Apply 3 thin, even coats of adhesive to surface of boat and patch.

Wait 5minutes between each coat.  
After 3rd coat, wait 10-15 minutes before placing patch on boat. Use hand roller to press patch onto boat skin.

4. Wait for at least 24hours before reinflating and the boat.

### LARGE REPAIRS on the SKIN, SEAMS, BULKHEADS and TRANSON

For all large repairs it is recommended that the boat be returned to your dealer. If possible, contact the dealer.

### INSTALLING NEW CHECK VALVES

Lubricate check valve stem with silicone or soapy water solution to facilitate installation.

## WARRANTY

1. The warranty for each new inflatable boat and accessories attached to the boat (here in after to be referred to as the "product") to be free from defects in material and workmanship, but only when sale to the consumer is made in a country to which distribution is authorized by us.

2. The warranty shall become effective only upon receipt of a completed Warranty Registration Card, which shall identify the product registered serial number. This warranty shall remain in effect as described below.

1-1. Hull fabric is covered by a full 5-year warranty against cracking, porosity and rot.

1-2. Hull seams are covered against delamination by a 1-year warranty.

NOTE : Seams are considered to have delaminated when the outer coating separates from the fabric base or the seam loses its structural strength. If delamination occurs on only one seam and not on the entire boat, the seam is to be repaired under warranty.

1-3. All other boat parts, including limited components such as car locks, lifting handle foot pumps, boat bag, transom holder, transom, "D" rings, stingers, "H" fittings and floor boards are covered by a one-year warranty.

3. Since this warranty applies only to defects in material and workmanship, it does not apply to normal wear and tear, or to damage caused by:

a. Neglect, lack of maintenance, accident, abnormal operation or improper installation or services.

b. Use of an accessory or part not authorized by us;

c. Participating in or preparing for racing or other competitive activity;

d. Alteration or removal of parts.

4. This warranty does not cover incidental or consequential costs or expenses such as haul-out, launch, towing transport and storage charges; telephone or rental charges of any type, inconvenience, or loss of time of income; or other consequential damages.

5. Customer must provide reasonable access to the product for warranty service by delivering the product for inspection to an authorized dealer, the purchaser shall notify the company in writing.

We shall then arrange for the inspection and repair, provided such service is covered under this warranty.

Purchaser shall pay for all related transport expenses and/or any other expenses associated with that service any product or parts shipped by purchaser for inspection or repair must be shipped with transportation charges prepaid.

The warranty Registration Card is the only valid registration identification and must be presented at the time warranty service is required.

Warranty claims will not be accepted without presentation of the Warranty Registration Card.

6. Our obligations under this warranty shall be limited to repairing a defective part, or at our discretion, refunding the purchase price or replacing such part or parts as shall be necessary to remedy any malfunction resulting from defects in material or workmanship as covered by this warranty.

We reserve the right to improve the design of any product without assuming any obligation to modify any product previously manufactured.

7. This warranty gives you specific legal rights and you may also have other legal rights which vary from country to country.

