

Bergen III Part list

Paket 1/2: A1
 A3 (verschieden zu B3!)

 B1
 B3 (verschieden zu A3!)

 C2, C5 (Löcher müssen oben je 2 vorhanden sein!)
 C3, C4
 C1 + Glasplatte

 + 1 Sitzkissen (langes/großes Kissen)

Paket 2/2: A2 (verschieden zu B2!)
 A4 (muss einen Fuß an nur einem Ende haben!)
 A5 (hat keine Füße)



 B2 (verschieden zu A2!)
 B4 (besitzt einmal seitlich Bohrlöcher und einmal oben, Teil
 gibt es nur einmal. „komisches Teil“)
 B5 (Frontteil ohne Füße)
 B6 (kleines Teil mit Füßen, hat oben keine Löcher,
 Verwechslungsgefahr mit C1, C5!)

 + 1 Sitzkissen, 3 Rückenkissen

Teile sind im Normalfall in den beschriebenen Paketen enthalten, es können allerdings Abweichungen auftreten. Deshalb genau kontrollieren!



ASSEMBLY INSTRUCTION

PART A:

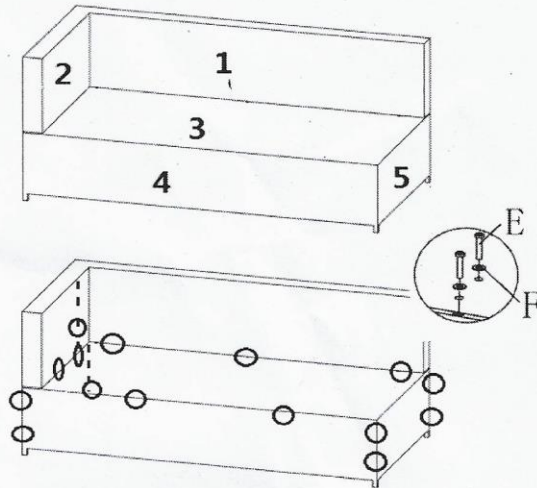
E	 M6*40	15
F		15
G		1



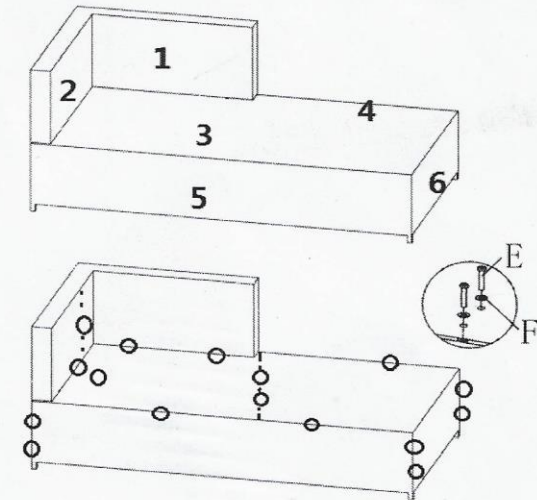

PART B:

E	 M6*40	16
F		16
G		



PART C:

E	 M6*40	12
F		12
G	