





















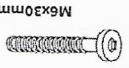

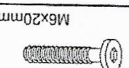
NO	PART LIST	DESCRIPTION	QTY/PCS
A		SEAT	1
B		BACK	1
C		ARMREST	1
D		BOLT (M8-50mm)	1
E		BOLT (M6-40mm)	10
F		STEEL BARRIER	11

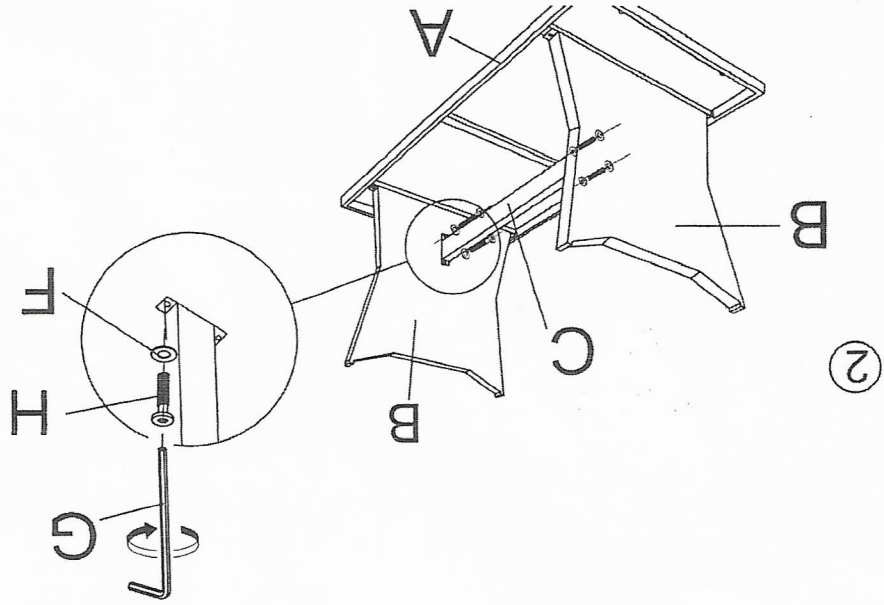
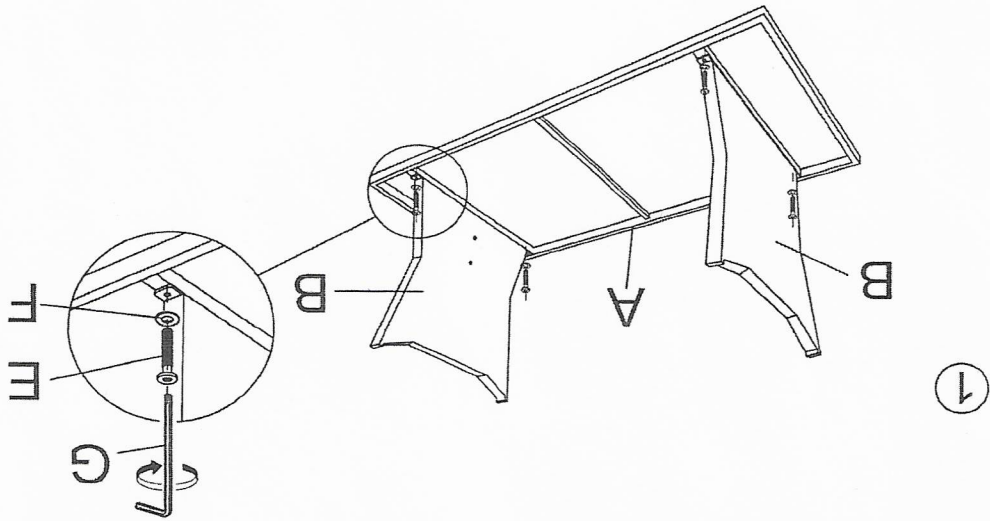
Table Assembly Instruction

1		G	1		D
8		F	1		C
4		H	2		B
4		E	1		A



NO	PART LIST	DESCR PTION	PTY/ POS
A		SEAT	1
B		BACK	1
C		ARMREST	1
D		BACK	1
E		BOLT (86x40mm)	1
F		BOLT (86x40mm)	13
G		STEEL WASHER	14
H		SCREW	1

