

MODELL LAVENDEL

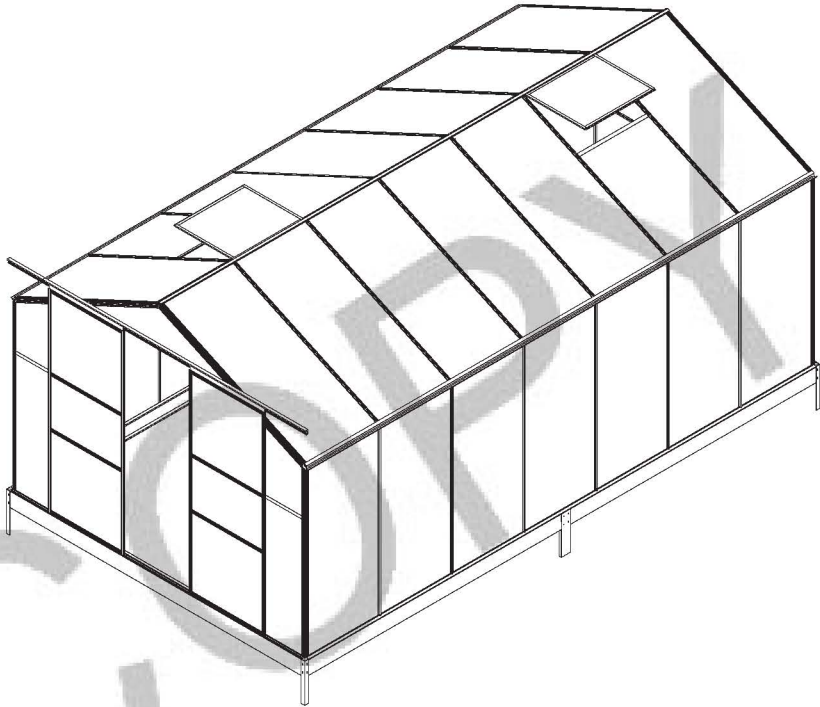

NUMBER 2045

Due to continuing improvements, actual product may differ slightly from the product described herein.

PLEASE READ THE ASSEMBLY INSTRUCTION CAREFULLY BEFORE USE.

GENERAL SAFETY WARNINGS AND INSTALLATION ADVICE

KEEP WORK AREA CLEAN AND DRY. Cluttered, damp, or wet work areas may cause injuries.

STAY ALERT. Do not use this product when you are tired or distracted from the job at hand. We recommend that you use gloves during assembly.

MAINTAIN A SAFE WORKING ENVIRONMENT. Keep the work area well. Make sure there is adequate surrounding workspace. Avoid high traffic areas. Always keep the work area free of obstructions, grease, oil, trash, and other debris.

PROPER LOCATION. Make sure the Greenhouse is located on a flat level surface.

DO NOT INSTALL THE GREENHOUSE IN AREAS SUBJECT TO HIGH WINDS OR ERRECT ON A WINDY DAY.

Although this greenhouse is designed to withstand greater wind loads than other conventional greenhouses, do not install it in areas subject to high winds or erect on a windy day. Any building left partially constructed may be seriously damaged if left in this state. It is your responsibility to safely and securely anchor the greenhouse, having regard to the windiest conditions in the area.

CHECK PARTS BEFORE ASSEMBLY. All parts have been labeled well, please sort, separate and identify all parts and hardware before construction, and check against the Parts List in this manual.

REQUIRED TOOLS

Bellow tools are required for the erection of the greenhouse. These tools should be at hand before starting work:

- 1.Screw driver
- 2.Spanner (the aperture is 8mm)
- 3.Measuring tape
- 4.Silicon glue
- 5.Gloves
- 6.Rubber hammer

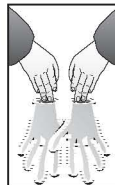

NOTE: The warnings, precautions, and instructions discussed in this manual cannot cover all possible conditions and situations that may occur.

P

POLYCARBONATE PANEL

Note

✂ - Remove approximately 2 inches of film from all sheet edges before installing, and remove all film immediately after the construction is completed.

✂ - Please note the side with the sticker of "THIS SIDE FACE THE SUN" must face towards the sun.

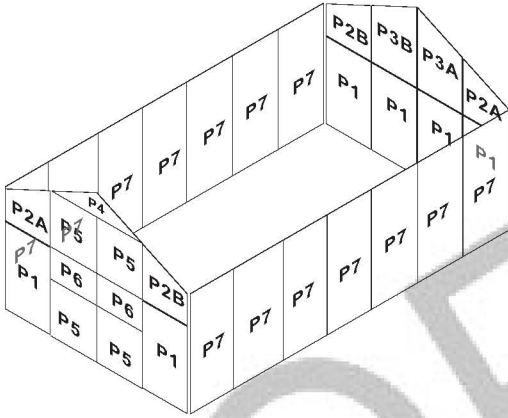
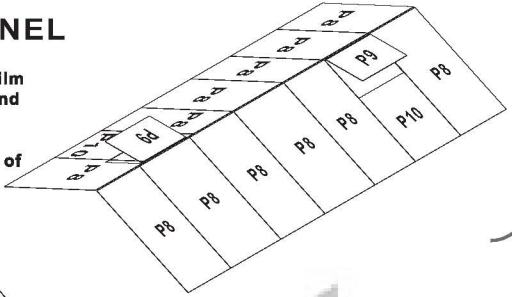

POLYCARBONATE PANEL

Sticker of "THIS SIDE FACE THE SUN"

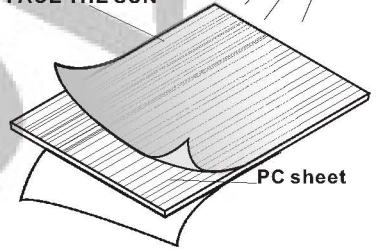

A

ALUMINIUM FRAME

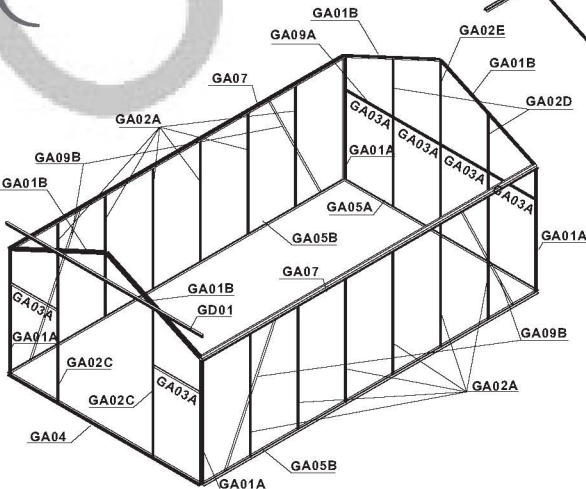
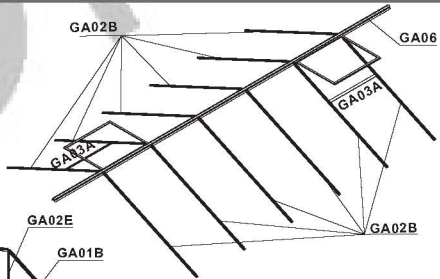

SCREW INSTALLING METHOD

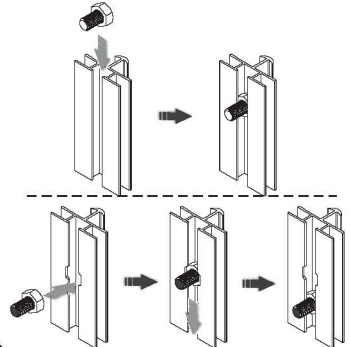

D

DOOR ASSEMBLY

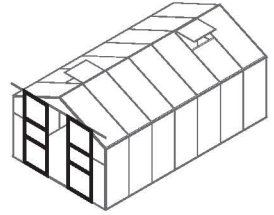

GD01



GD03



GD02



GD04



S02

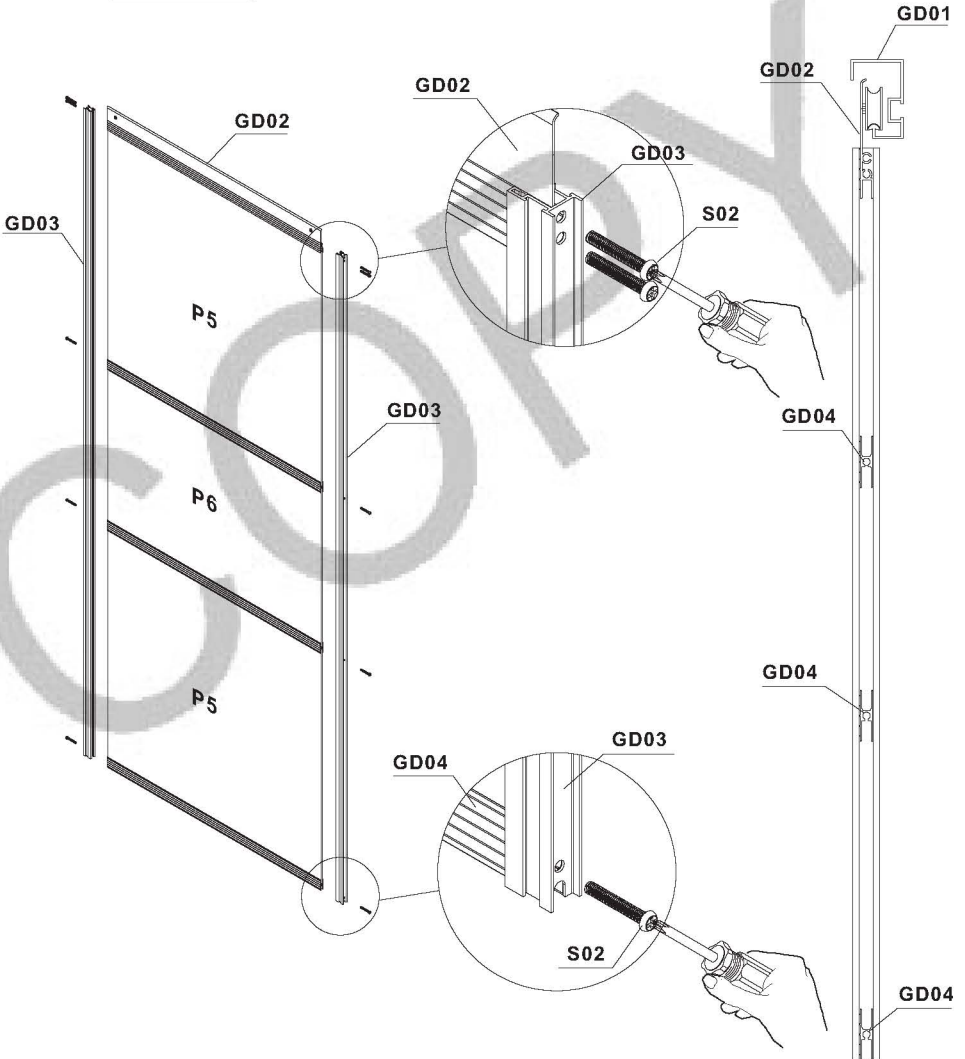

W

WINDOW ASSEMBLY

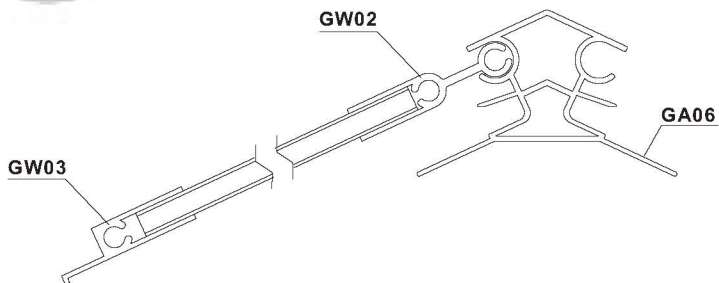
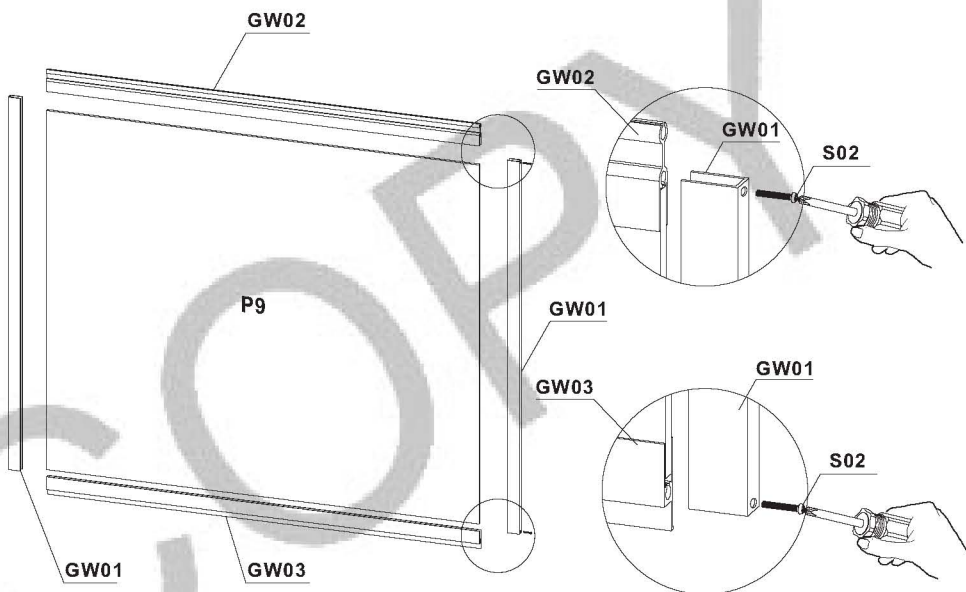
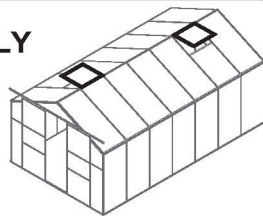

B

BASE ASSEMBLY

Note



In order to facilitate installation, we recommend installing the base firstly. Please ensure the base is located in the horizontal position, and ensure the two diagonal lines of the base are the same size.

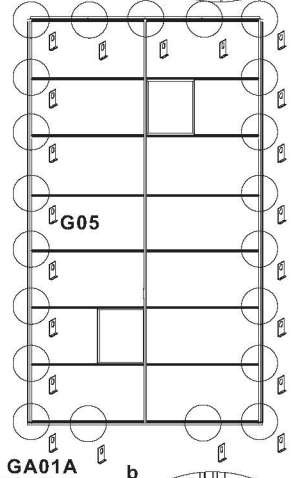
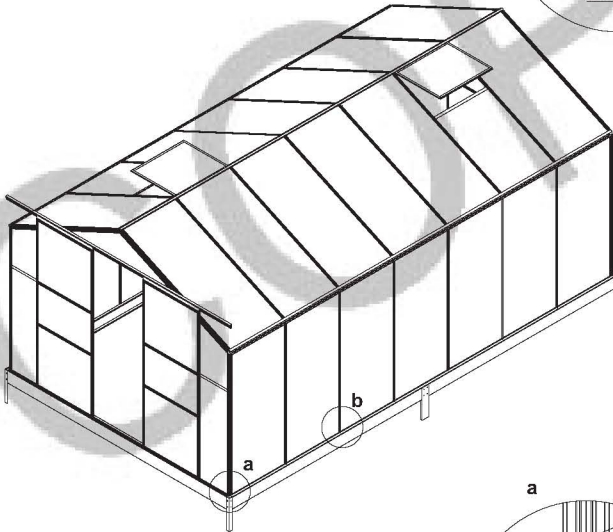
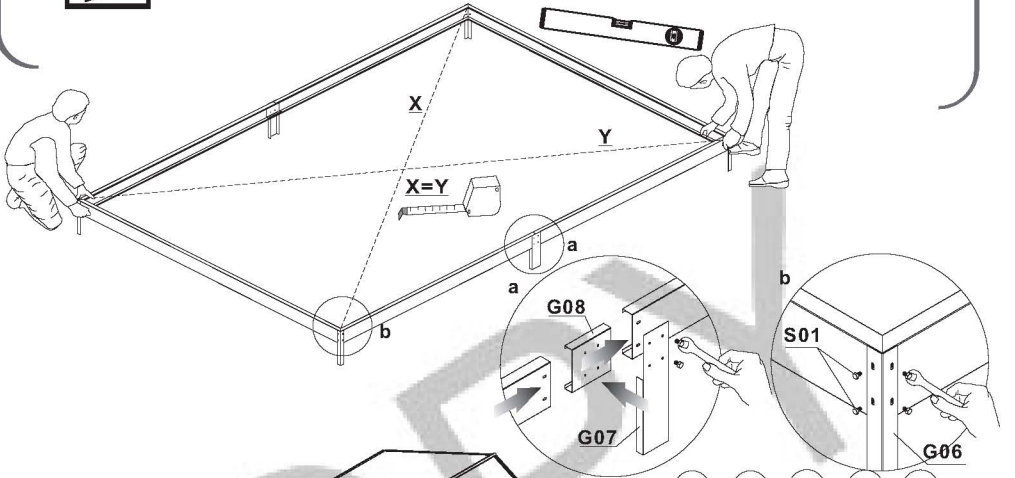

	G05		G07
	S01		G08
	G06		

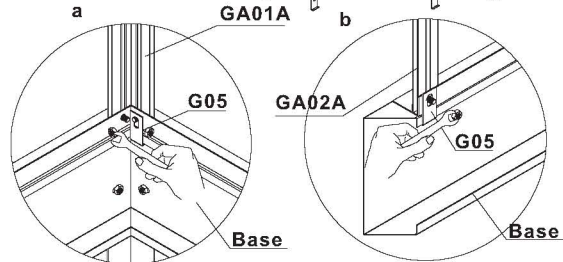

Note Before installing GA01A and GA02A these vertical frames, please install the G05.

1

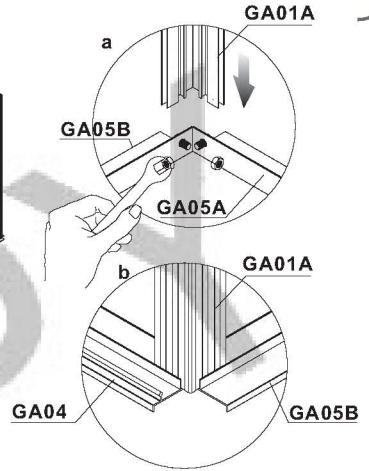
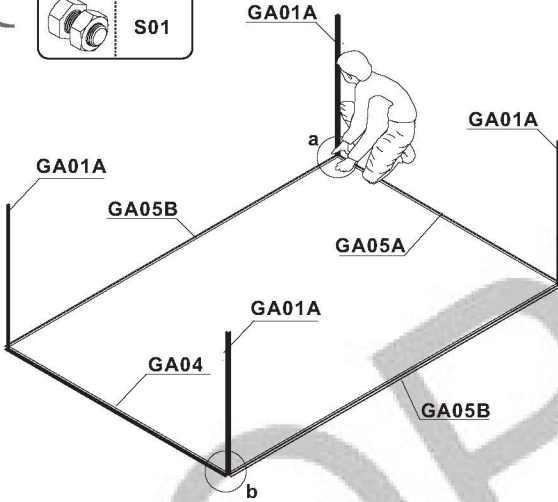
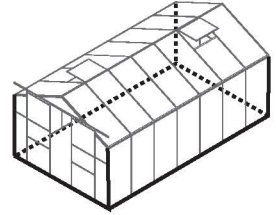
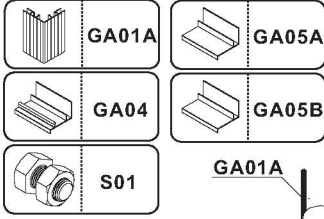

2

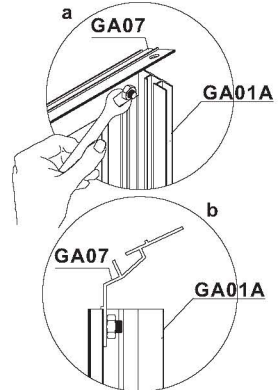
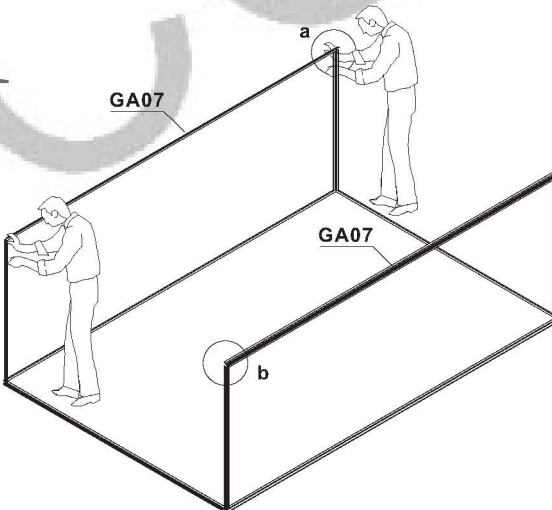
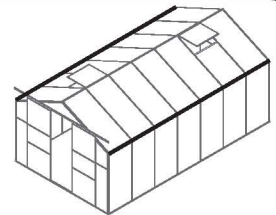

3

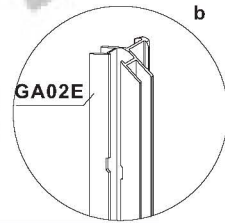
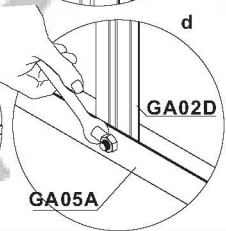
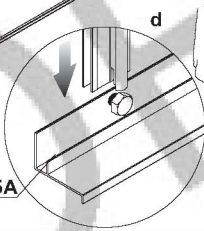
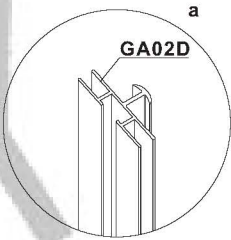
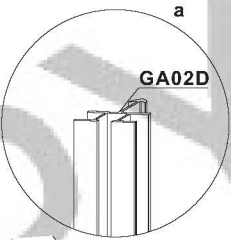
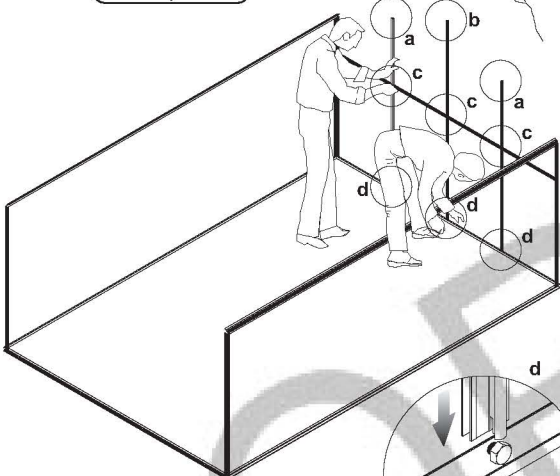
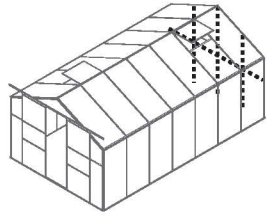
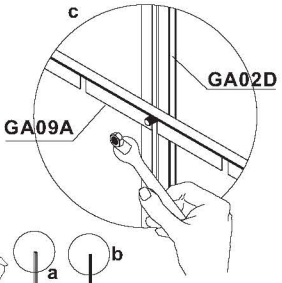

4

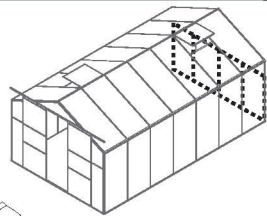
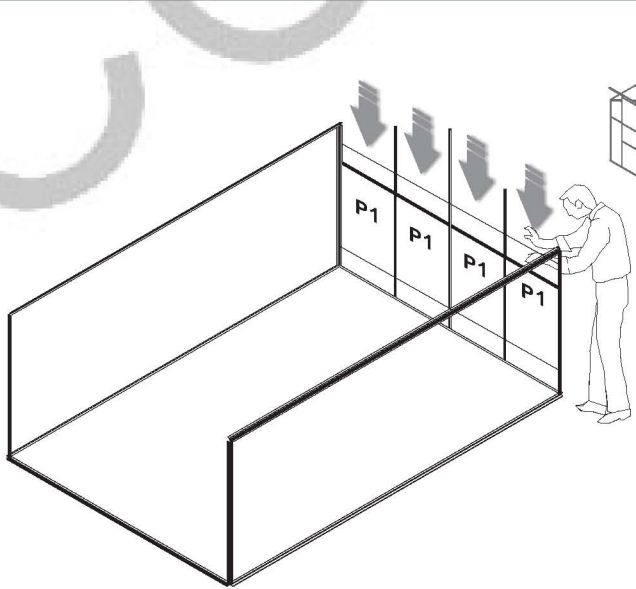

5

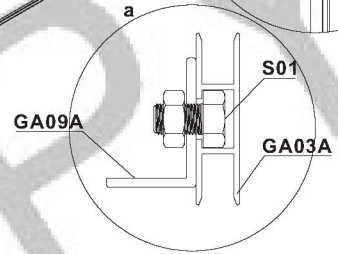
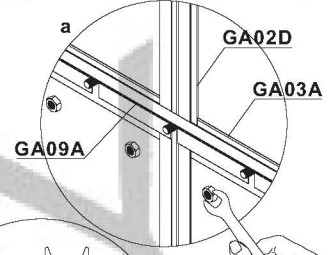
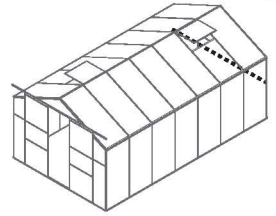
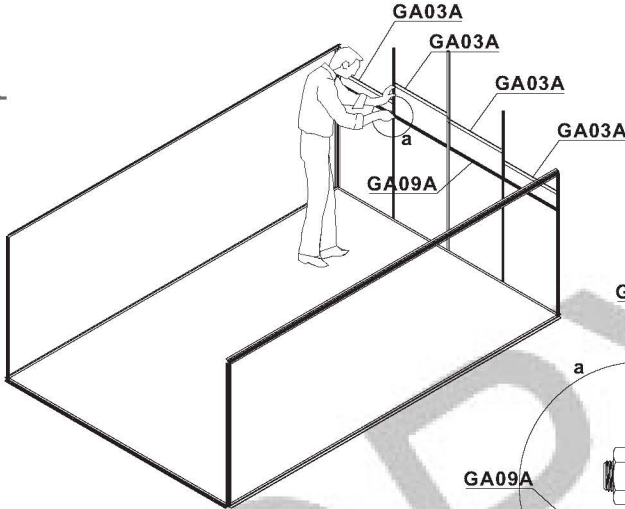

6

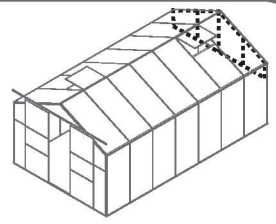
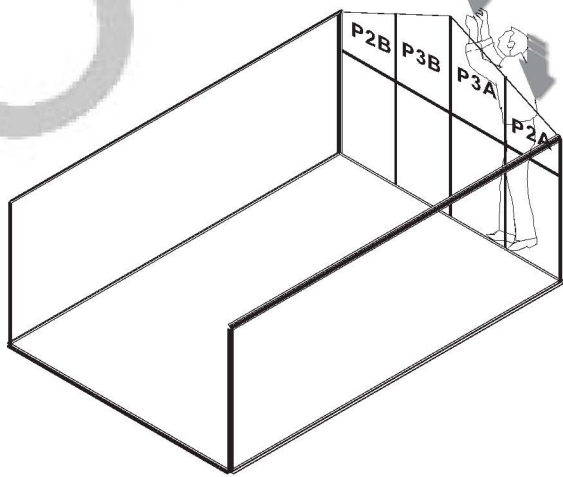

7



GA01B



S01

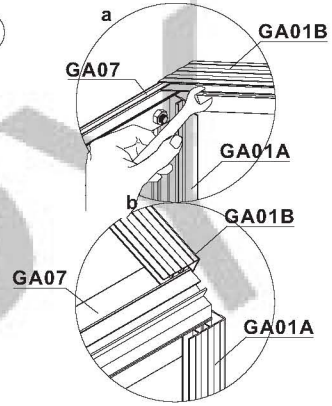
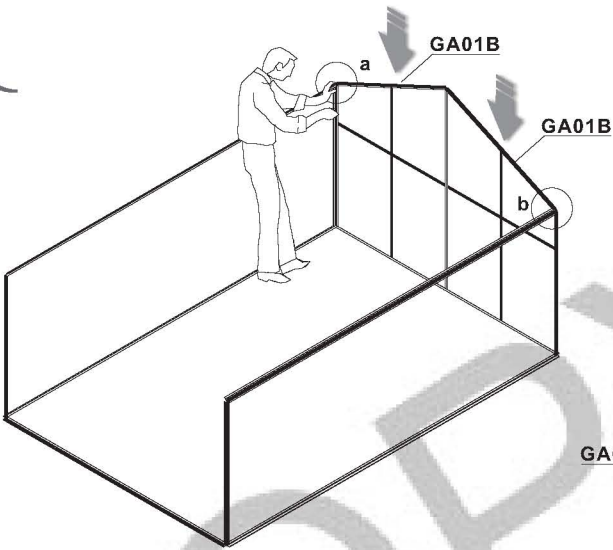
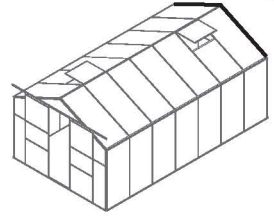

8



G01



G04



G02

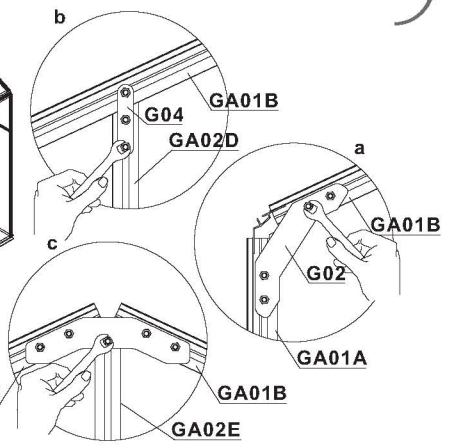
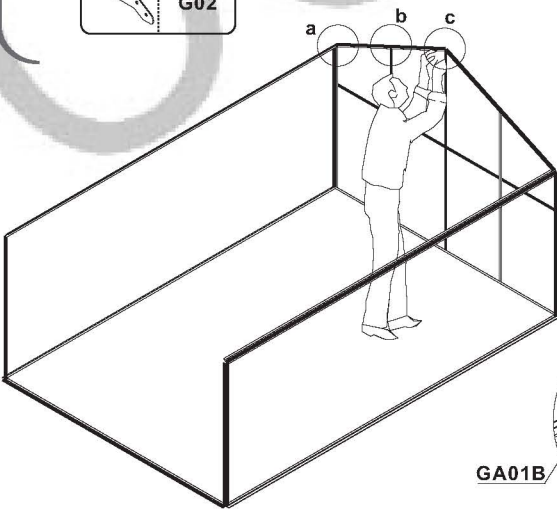
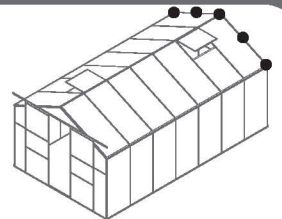

9

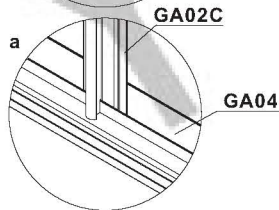
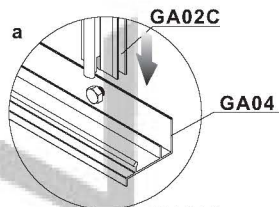
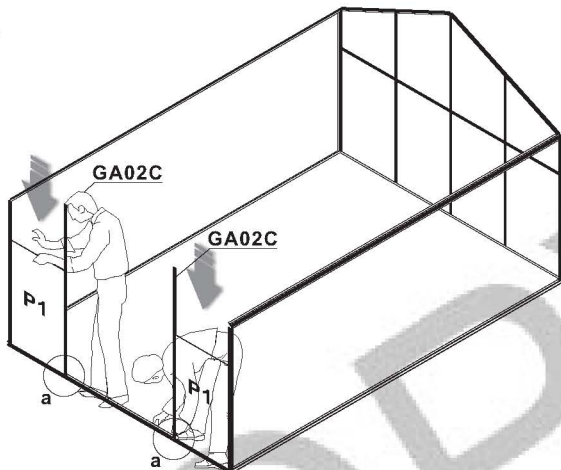
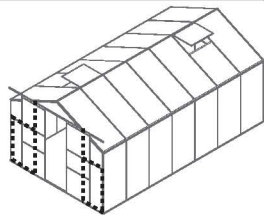

10

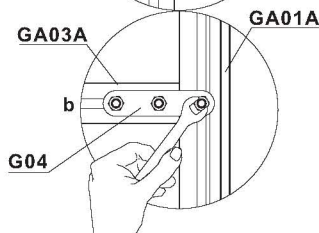
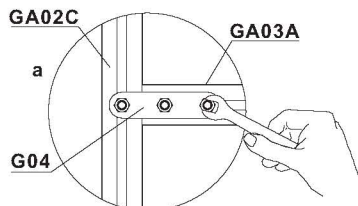
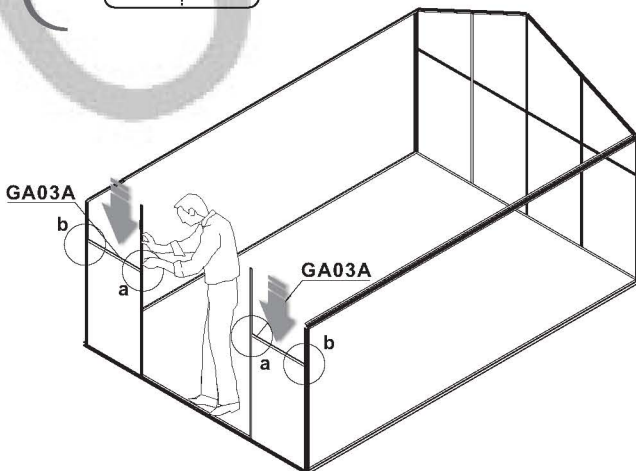
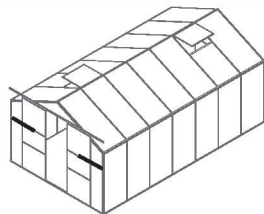

11

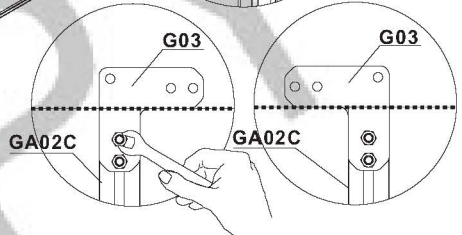
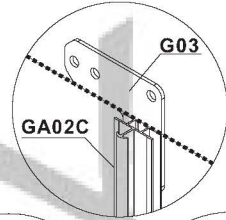
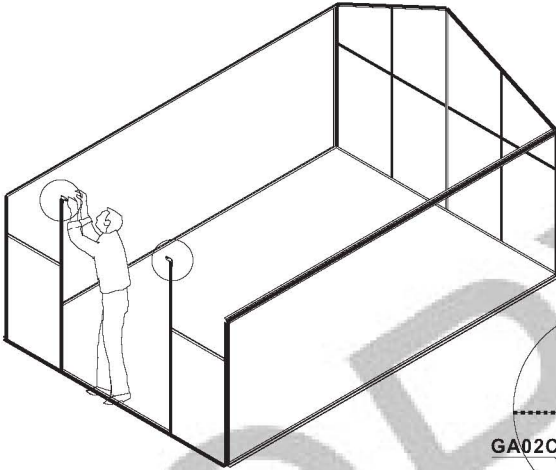
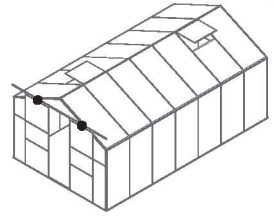

12

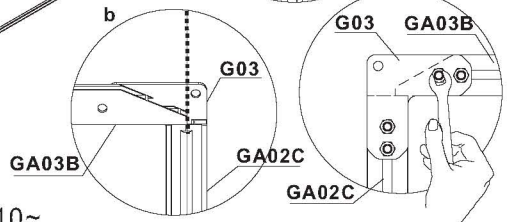
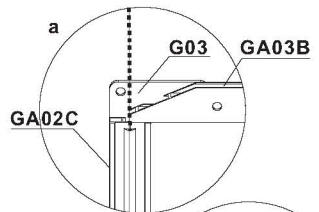
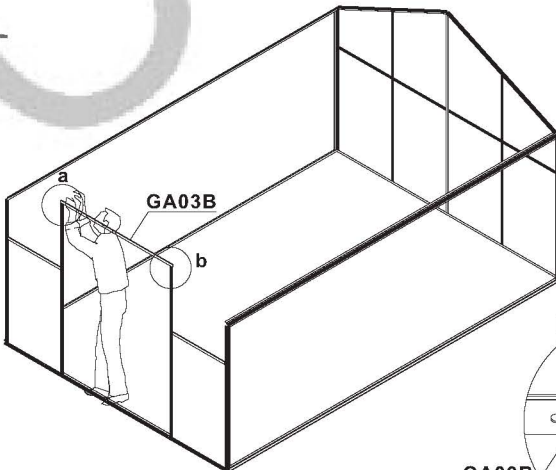
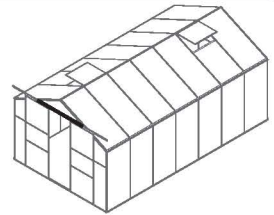

13

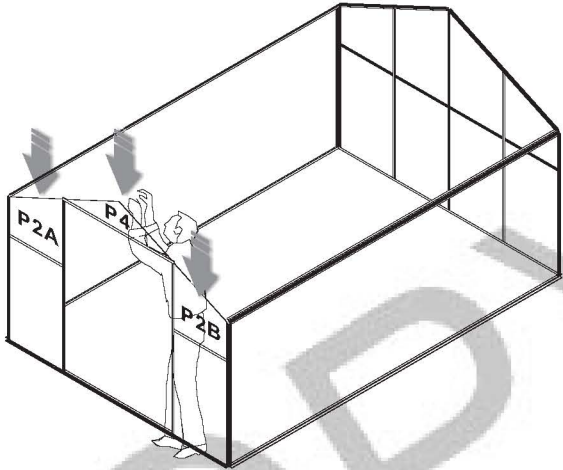
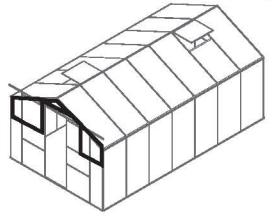

14

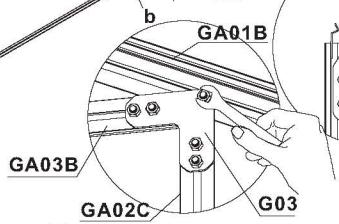
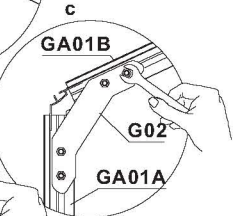
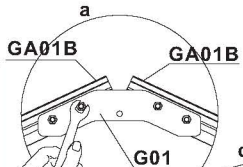
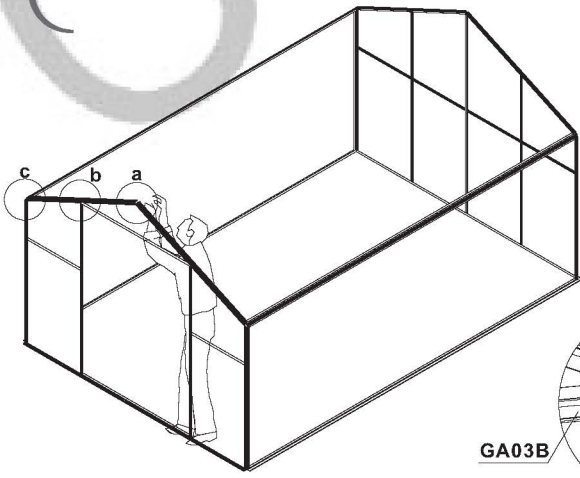
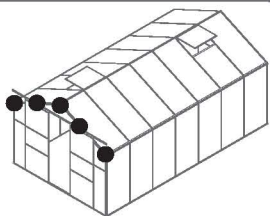
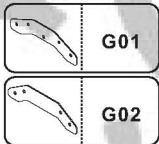



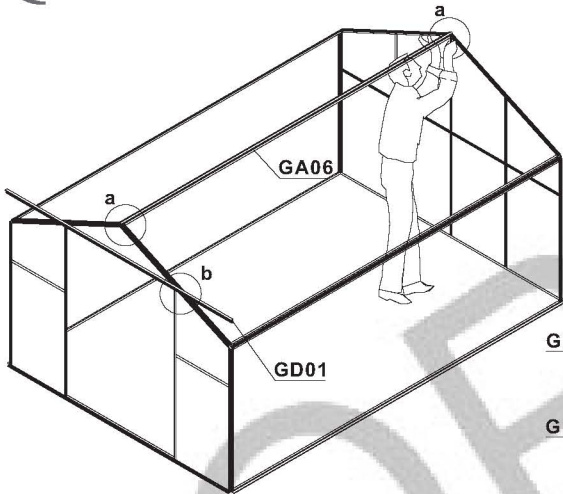
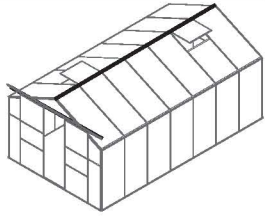

15

	GA06		S01
	S03		GD01



16

	GA02A		GA09B		S04
	GA02B		S01		

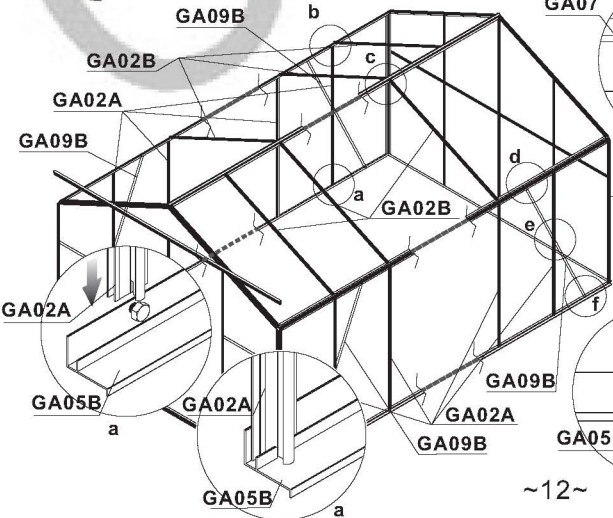
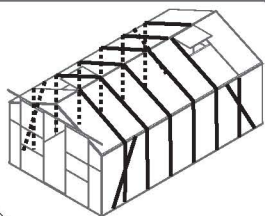

17

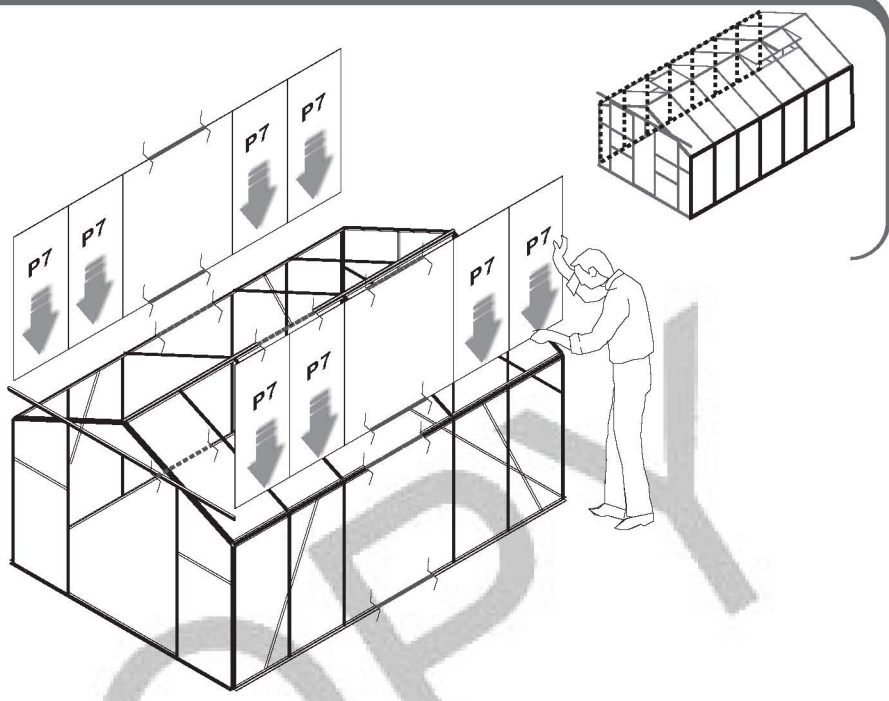

18

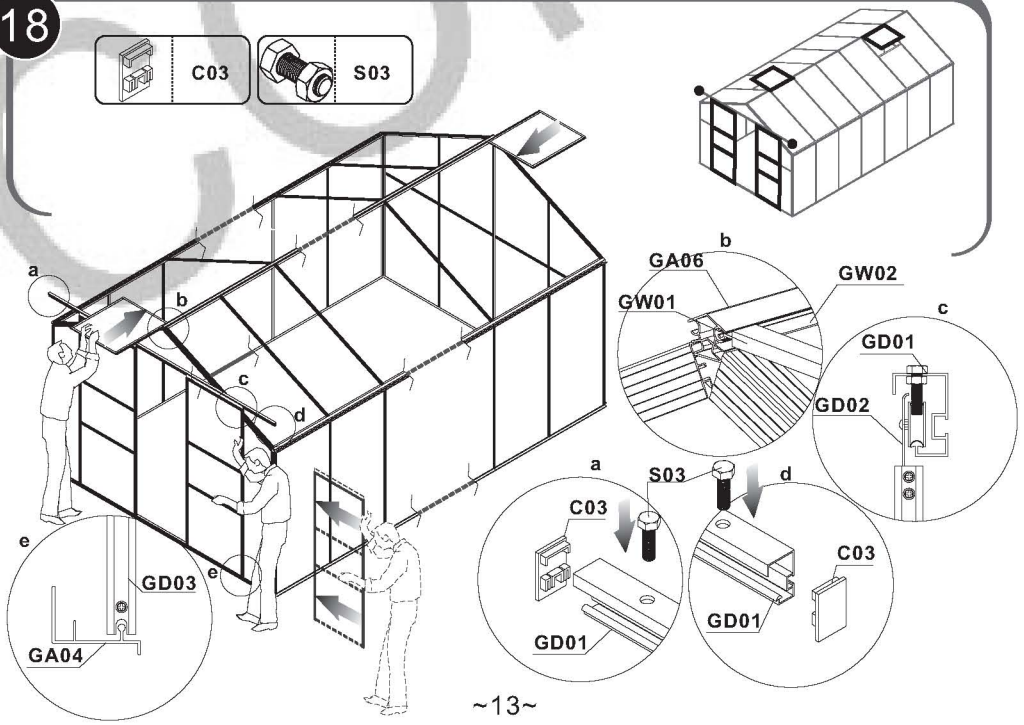

19

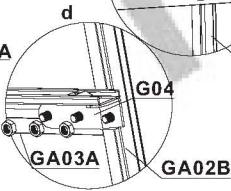
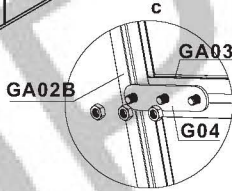
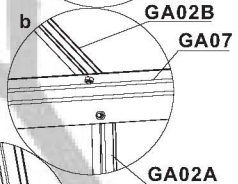
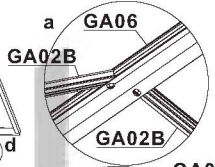
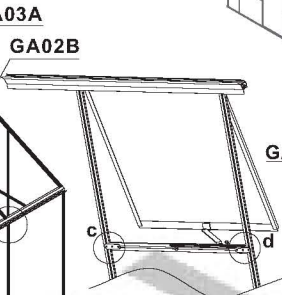
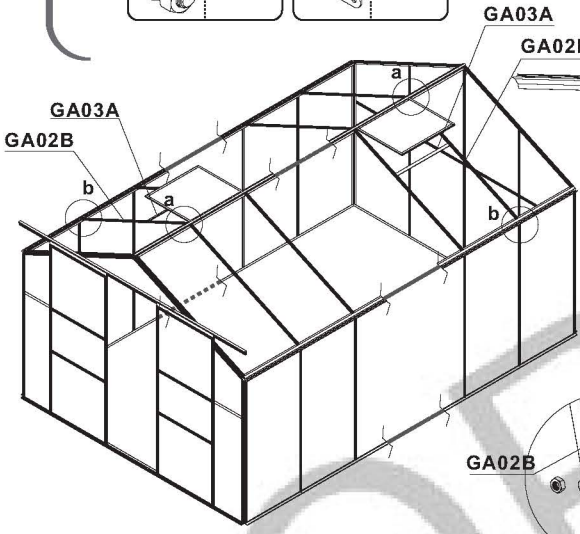
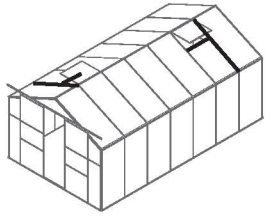
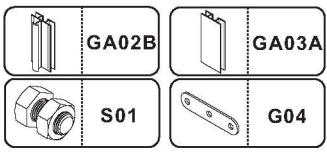

20

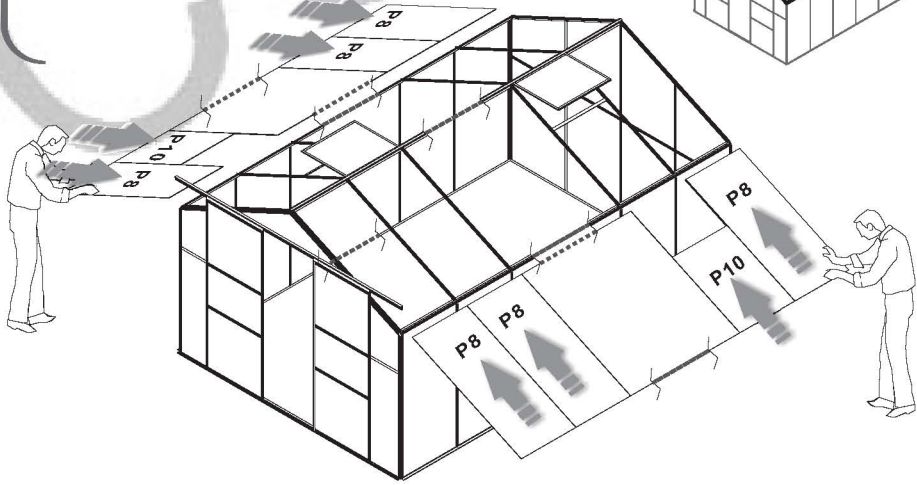
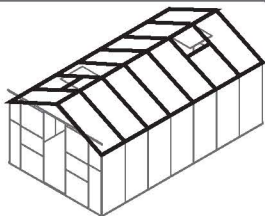

21

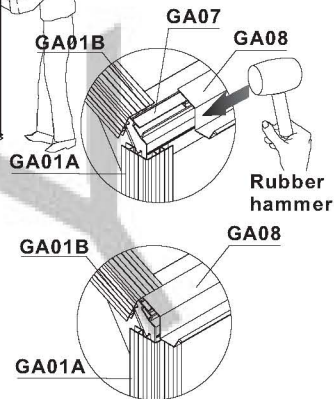
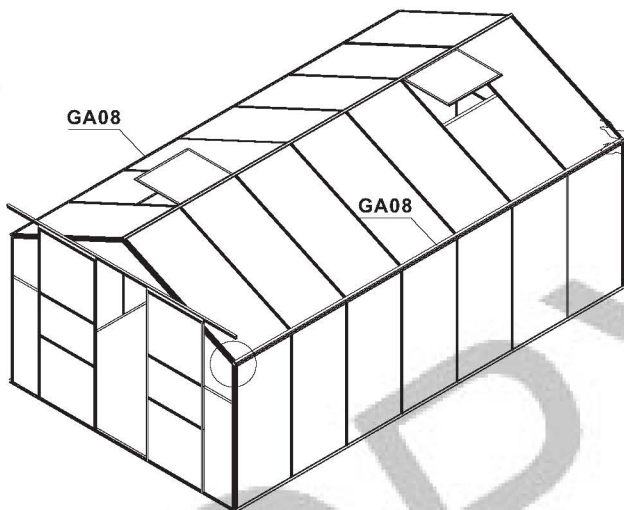
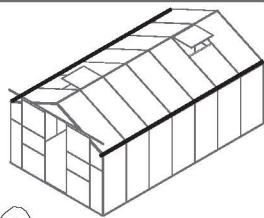

22

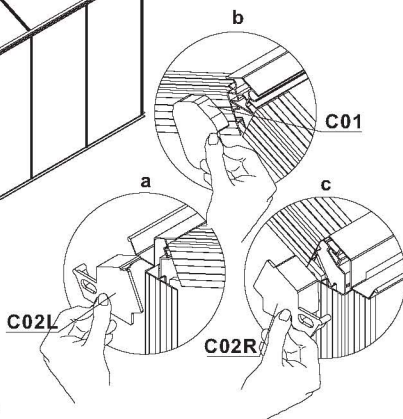
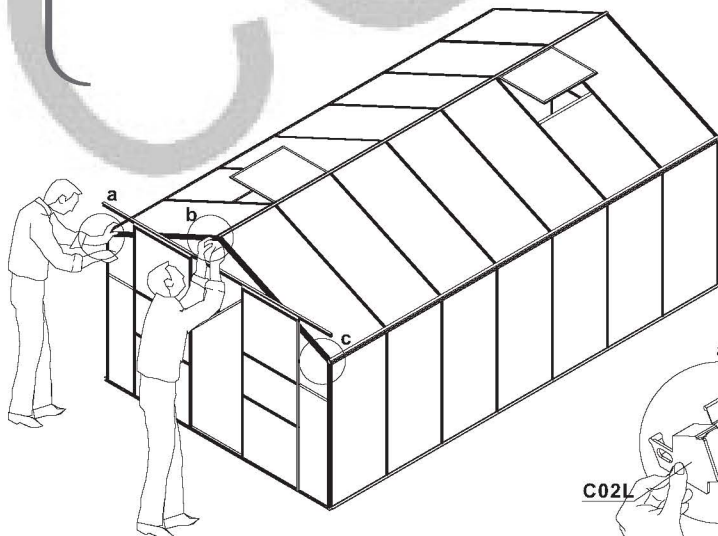
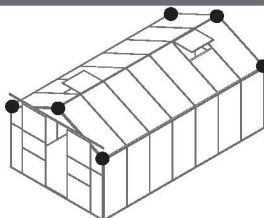
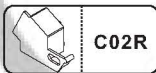







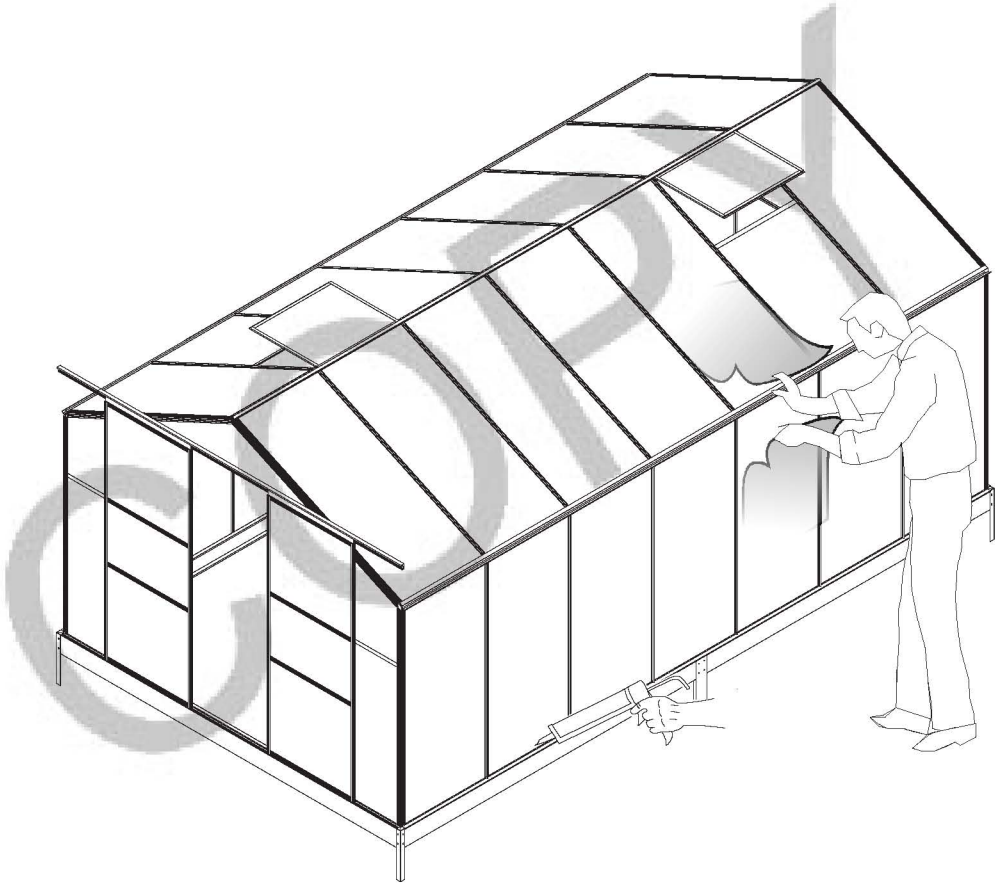







23





























- Silicon glue is our recommendation for sealing the polycarbonate panel bottom and the aluminum profile bottom together, and it is no necessary to use the silicon glue if it has been very tight between the polycarbonate panel bottom and the aluminum profile bottom.
- Removing all film for the polycarbonate sheet immediately after the construction is completed.



PARTS LIST

	GA01A	4
	GA01B	4
	GA02A	12
	GA02B	12
	GA02C	2
	GA02D	2
	GA02E	1
	GA03A	8
	GA03B	1
	GA04	1
	GA05A	1
	GA05B	2
	GA06	1
	GA07	2

	GA08	2
	GA09A	1
	GA09B	4
	GW01	4
	GW02	2
	GW03	2
	GD01	1
	GD02	2
	GD03	4
	GD04	6
	G01	2
	G02	4
	G03	2
	G04	10

	G05	21
	G06	4
	G07	2
	G08	2
	C01	2
	C02R	2
	C02L	2
	C03	2
	S01	180
	N01	194
	S02	29
	S03	5
	S04	9



Remark:

For easy finding the correct part, different color label shows different part: Red label for front & back cover, yellow label for the middle, green label for shared parts, purple label for the door, blue label for the window and brown label for accessories.