

CTION MANUAL

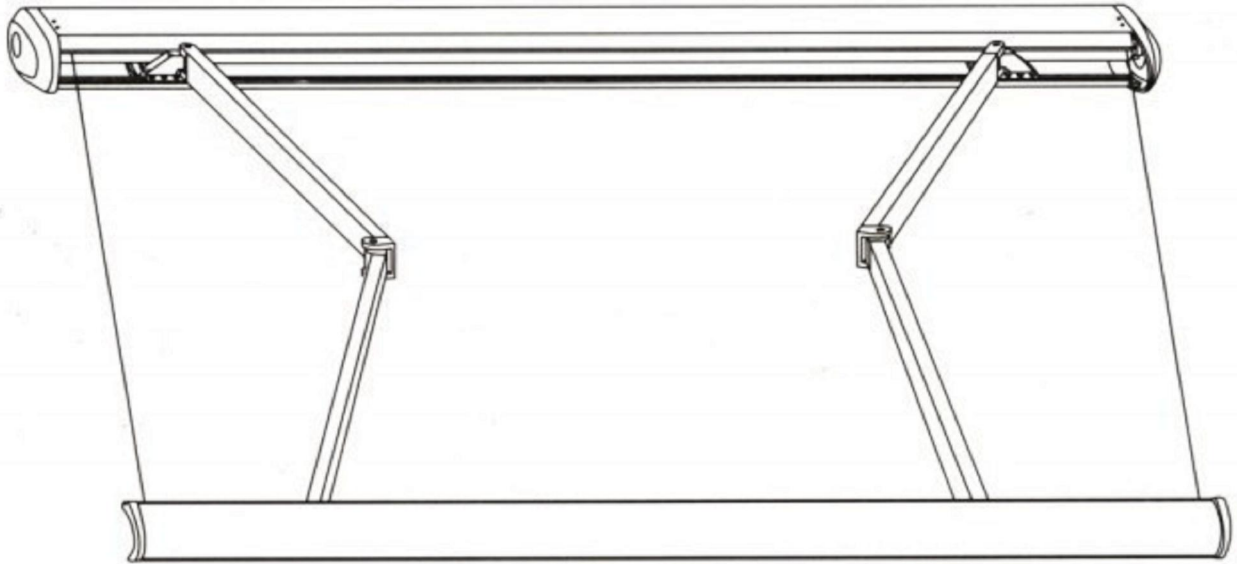

·FULL-CASSETTE AWNING

safety instructions

WARNING NOTE:

FOR PERSONAL SAFETY,IT IS IMPORTANT TO FOLLOW THESE INSTRUCTIONS,PLEASE KEEP THESE INSTRUCTIONS IN SAFE PLACE



This warning triangle calls attention to Hazards that can lead to death or to severe Injuries or which are important for the Functioning of the awning.



Awning is intended primarily as protection against the sun.If a wind starts up or it begins to rain heavily(formation of water pockets)or snow begins to fall,it should be retracted immediately.Operating them in winter conditions can result in damage



This sign identifies important notes

Required Tools

- Drill
- Masonry drill bit, 14mm
- Level
- Wrench
- Stepladder



Read these instructions carefully before you Begin with the assembly or operate the Awning.



Before assembly please check whether the Delivered assembly brackets agree in type And amount with the order and whether the Mounting base specification provided in the Order coincide with the actual conditions.



Note:

Sheeting was used to protect the paint This must be removed afterwards.



When extended,various forces,including wind and rain,will affect an awning,These sometimes substantial forces must be absorbed by the awning and transferred to the assembled structure via its mounting brackets.under extreme loads,excessive tractive force can be exerted on the anchor bolts.



Warning:

The awning is heavy.A minimum of two Persons is required to attach the awning to the wall brackets.



Therefore,before starting assembly,check the load bearing capacity of the mounting base and if necessary take corresponding measures to ensure stable installation of the brackets.If the mounting base is unstable, you may wish to consult a specialist in your vicinity









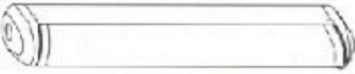

DO NOT ALLOW CHILDREN TO PLAY IN THE WORK AREA DURING ASSEMBLY AND ADJUSTMENTS.

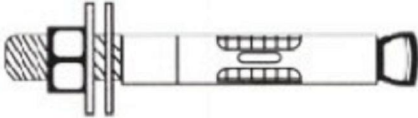

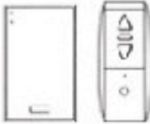
Please make sure that your hands are clean at the time of the assembly, otherwise you may soil the awning fabric and frame.

Parts List

PARTS LIST	PICTURE	OPTIONS
Awning Unit		✓
Bracket or ceiling bracket		✓
Bolt		✓
Hand-crank		
Motor Adjustor		
Remote Control System		
Catalogue		
Video		

 **Note:**

1. Awning unit is including: economic awning or no cassette awning or half cassette awning
2. Bracket: <3.6m awning is with two brackets, 3.6~5.1m is with three brackets, 5.1~6.0m is
3. Bolt: on bracket is matched two bolts
4. Hand-crank: one manual awning is matched one hand-crank
5. Motor adjustor: one motor is matched one adjustor
6. Remote control system: M01 motor is including one emitter, M02 is including one emitter And receiver, M03 is including one emitter, receiver and hand crank, M04 is including One emitter and hand-crank

[Click Here to upgrade to Unlimited Pages and Expanded Features](#)

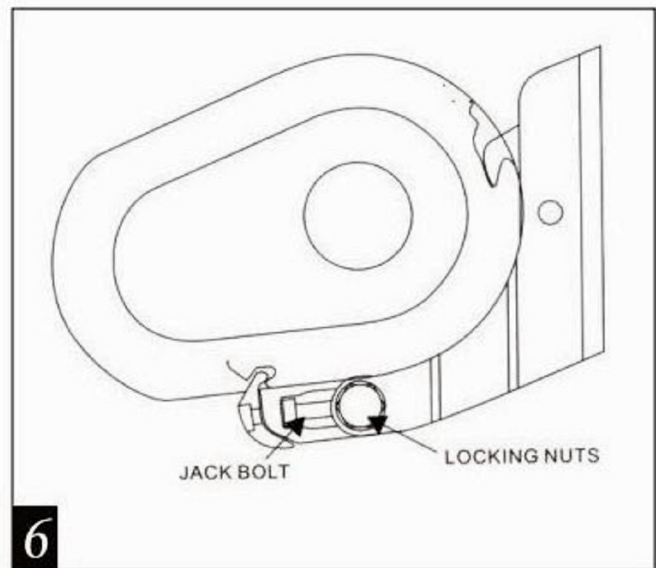
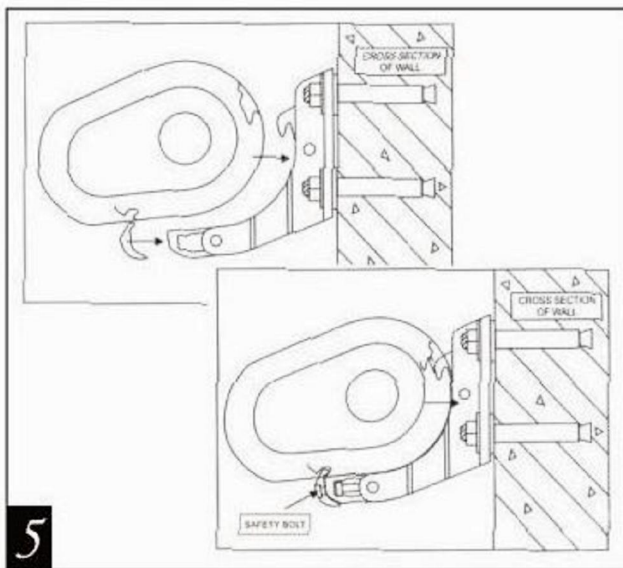
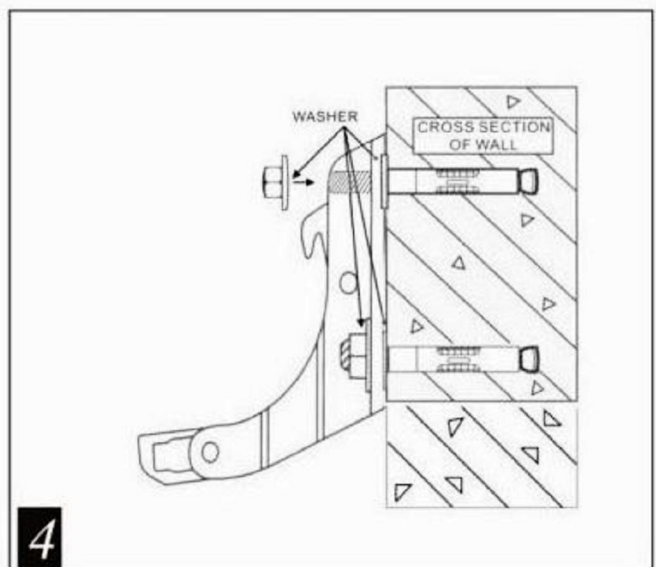
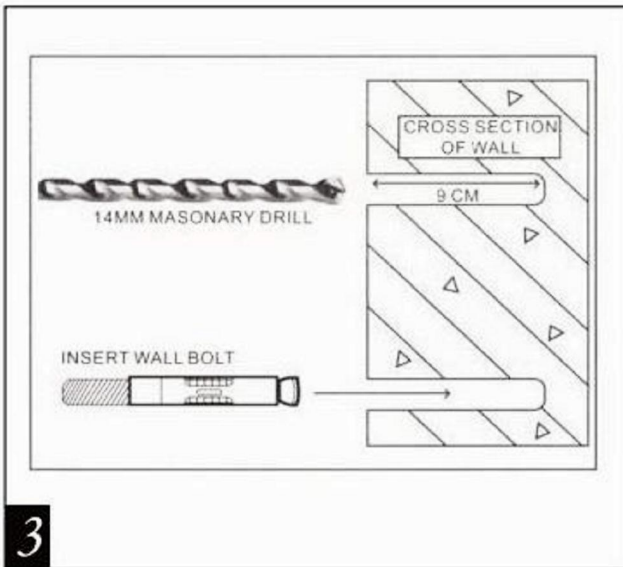
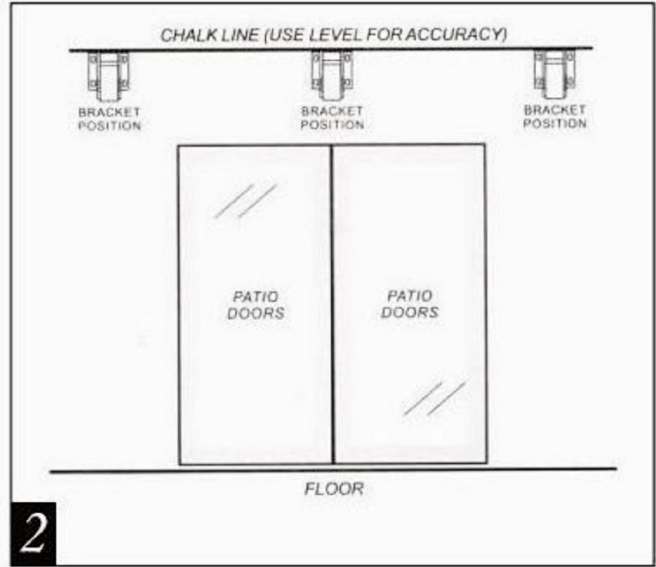
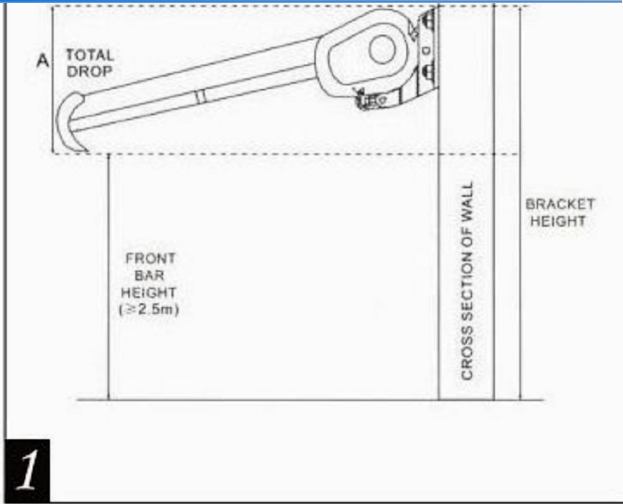

Assembly

Step 1:

Carefully remove the awning from the box and remove the Styrofoam protectors from the awning. remove the plastic bags and plastic guards from the awning and carefully place the awning aside to avoid having it damaged by scratches or otherwise damaged or soiled during assembly.

Think about how you will be securing the awning to the wall ahead of time. In the event you would like to mount it above a patio door. You should leave a space of at least 20cm above the door frame if there is enough space available above the door frame.

The approximate total drop area of the awning varies depending on the type:

Bracket Height	3~5m	4.5~6m
A(Total Drop)	30cm	50cm

Ensure that you also take this drop height into account in your decision on where to install the awning. The drop angle can still be changed after assembly. The ideal drop angle, however, has already been sent in the factory and may only be changed minimally.

picture [1](#) : it shows the drop of the awning when it is fully extended. (Total drop, height of front bar $\geq 2.5m$, cross section of the wall, bracket height)

Step 2:

The positions of wall brackets were marked on the awning in the factory.

measure the width of the awning with a ruler and note the positions of wall brackets.

picture [2](#) : Draw a horizontal line at the height of the required places as illustrated in the image and use a long ruler, a level and chalk for this purpose.

mark the corresponding places on the wall by running a pencil through the holes at the bottom of the brackets.

Step 3:

Use a 14mm masonry drill bit to drill the holes for the brackets at the appropriate marks on the wall.

Picture [3](#) : The holes should be 9cm deep in the wall and must be drilled through solid brick or concrete. Do not drill through mortar because this does not offer the support that is required for the awning.

Installation on timber houses and sheds:

The awning can also be installed on timber houses if their walls can carry the weight of the awning. In this event, ensure the brackets are firmly secured to the outside of solid wooden beams.

The anchor bolts from the delivered package are not suitable for mounting the awning to wooden beams. Instead buy carriage bolts of adequate length and of an appropriate diameter and secure the awning with them.

[Click Here to upgrade to Unlimited Pages and Expanded Features](#)

Picture  4 :After inserting the wall bolt,add the washers and then the wall brackets.Now place the Washers on the bolt heads and firmly tighten the 17mm nuts.

 **Note:**

- 1.It may be necessary to drive the anchor bolts in with a wooden mallet because they do not go in easily. Do not use a metal hammer for this purpose because this could damage the threads on the top of the Bolts.
- 2.If the bolts need to be driven into the wall with a hammer,we remomend initially placing the nut on the Screw loosely(only placing it loosely on the bolt) because this avoids damaging to the bolt threads.
- 3.Firmly tighten the bolts with a 17mm hex key:it is best to use a hex key with a closed end rathae than an Open end because this will avoid damaging to the nut of it should slip.
- 4.As soon as they are fully inserted,the brackets must sit firmly in the wall.If they are still moving in any Form.you must further tighten it.
- 5.Do not try to secure the wall brackets to loose wall stones or any surfaces that are not absolutely firm.
- 6.Ensure that the wall brackets are screwed firmly to the wall,so that they can in no case tear out when The awning is installed.

Step5:

Now your awning can be secured to the wall brackets.

Picture  5 :At least two ladders or chairs are required to install the awning in order to obtain the required Height.Ensure that the ladders or chairs are firmly resting on the ground so that you can not fall.only Use ladders that are suitable for such assembly work.

 **Note:**

In case tha pole can not be inserted into the wall brackets,you should sightly loosen the wall brackets Screws and then try it once again.

This time,move the awning slightly forward and backward until the pole slips into the brackets.

Then immediately insert the safety bolts on the front side of the wall brackets and tighten the nuts with a 19mm hex key.Ensure that the safety bolts for the wall brackets have been adequately secured.

Step 6:

Remove the protection belts from the awning if you have not done so already.Open the awning now,you Will discove the awning is not level,you can adjust the angle of arms to level it.

Picture  6 :Loosen the 4*17mm LOCKING NUTS and then turning the 2*13mm JACK BOLT by a spanner To the desired angle.

 **Note:**

The forward pole must always be level.To ensure that both sides are completely level,a built-in level is Located on the forward side:the air bubble must be exactly in the middle of the level.

Place the plastic screw caps on the screws to protect them against weather based corrosion.

move the hand-crank and keep it in a safe and dry place.

 **PLEASE DO NOT LET CHILDREN PLAY WITH THE AWNING.**

If you have any questions about installation or if you require spare parts, please contact your dealer.

 **BE SURE TO NOTE.**

The awning's gear box has no stop to limit revolutions of the roller. To avoid damaging to the fabric, therefore, the awning fabric must always be properly roller up. The fabric must be stretched tightly.

ANY QUESTION OF MOTORIZED OPERATION, PLEASE REFER TO THE MOTOR INSTRUCTION.

Repair Manual for Usual Malfunction

No.	PHENOMENON OF MALFUNCTION	REASON	REPAIR METHOD
1	The awning does not work when operated by remote control	① No power supply	① Check the plug to see whether its properly connected
		② The residual current automatic circuit breaker is at off position	② Call on the professionals to inspect
		③ The voltage is too low	③ Call on the professionals to inspect the voltage whether it accords with the requests
2	When operated by remote control, the awning does not work although the receiverd signal from remote receiver can be heard	① Remote receiver and motor are switched or wire from motor disconnected with pin	① Check two placed: fasten pins and screws
		② The motor switched off due to overheat protection	② The more will automatically resume operation after approx. 20minutes interval
3	Fabric s lax though the awning is extended entirely	Path length is incorrectly adjusted	Readjust path length according to the direction of the motor.
4	The cassette can not be close completely	Connecting position between front bar and front beam moved	Adjust position of the front beam till the cassette entirely shuttered
5	Unwanted noise when operating	Screw loosened	Check all screws come ine view and fasten the loosened
6	When operated by remote control, the indicative lamp does not work and no signal from receiver.	① Cell exhausted	① Changed a new cell
		② Cell disconnected	② Reset the cell