



GARTENPAVILLON „DAMASKUS“

Artikel-Nr.: 23104

365 x 300 x 225 cm

- AUFBAUANLEITUNG -



***Installationsvideos und Aufbauanleitungen
zu unseren Produkten finden Sie
in unsrem Shop beim jeweiligen Produkt***

***Weitere Produkte für Haus und Garten
finden Sie unter
www.jet-line.de***





















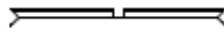











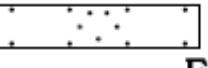





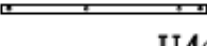

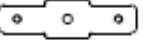
Produkt-Code:





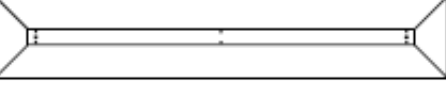









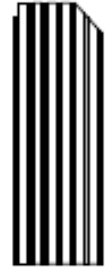















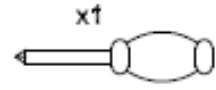

23104

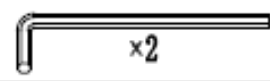
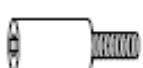
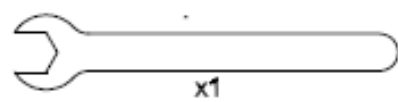
Produkt-Maße:

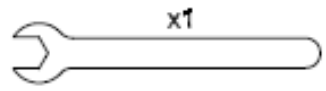
ca. 365 X 300 X 225 cm

Teile-Liste

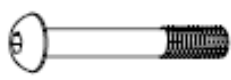
			
A (X4)		L (X4)	
			
A1 (X8)	A2 (X8)	M (X4)	
			
B (X2)		N (X4)	
			
B1 (X2)		N1 (X4)	
			
C (X2)		P (X2)	
			
C1 (X2)		Q (X2)	
			
D (X2)		R1 (X8)	S (X140)
			
D1 (X2)		T1 (X2)	
			
E (X2)		T2 (X2)	
			
E1 (X2)		U1 (X4)	
			
F (X4)	G (X4)	U2 (X4)	
			
H (X4)	H1 (X4)	U3 (X2)	U4 (X2)
			
J1 (X4)		U5 (X8)	U6 (X4)
			
J2 (X4)		V1 (X2)	V2 (X2)
			
K (X1)		V3 (X2)	
			
K1 (X1)		V4 (X2)	V5 (X2)
			
		V6 (X2)	V7 (X2)

									
W1(X2)	W2(X2)	W3(X2)	W4(X2)	W5(X2)	W6(X2)	W7(X2)	W8(X2)		
									
X1(X2)	X2(X2)	X3(X2)	X4(X2)	X5(X2)	X6(X2)	X7(X2)	X8(X2)	X9(X2)	X10(X2)
	Y (X4)		Y1(X4)		Y2(X1)				
	M6*16	1#(X21)					x1		
	M6*20	2#(X104)					x2		
	M6*10	3#(X16)					x1		
		4#(X112)					x1		
	M5*16	5#(X4)					M6*60	(X12)	
	M5*12	6#(X24)							
	M6*40	7#(X8)							
	M6*47	8#(X40)							
	M5*15	9#(X32)							

Aufbauanleitung

SCHRITT 1

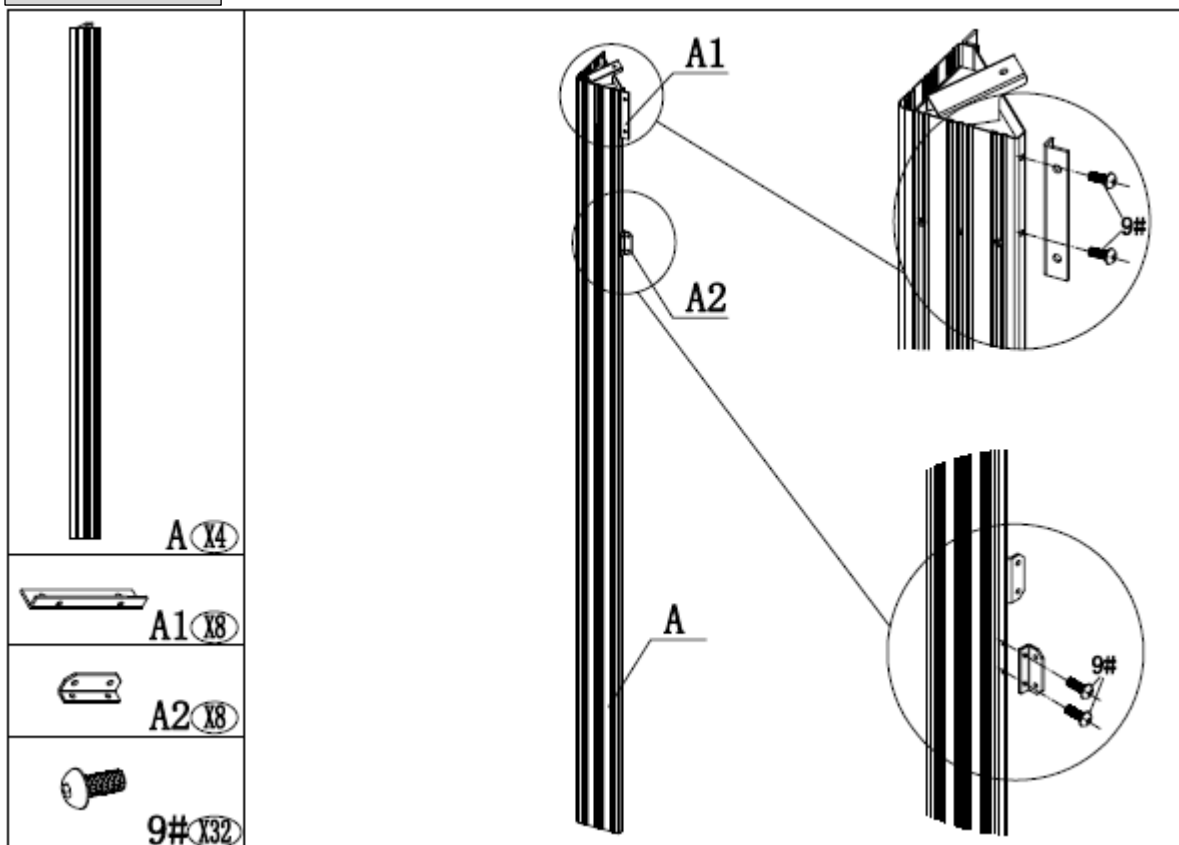

SCHRITT 2

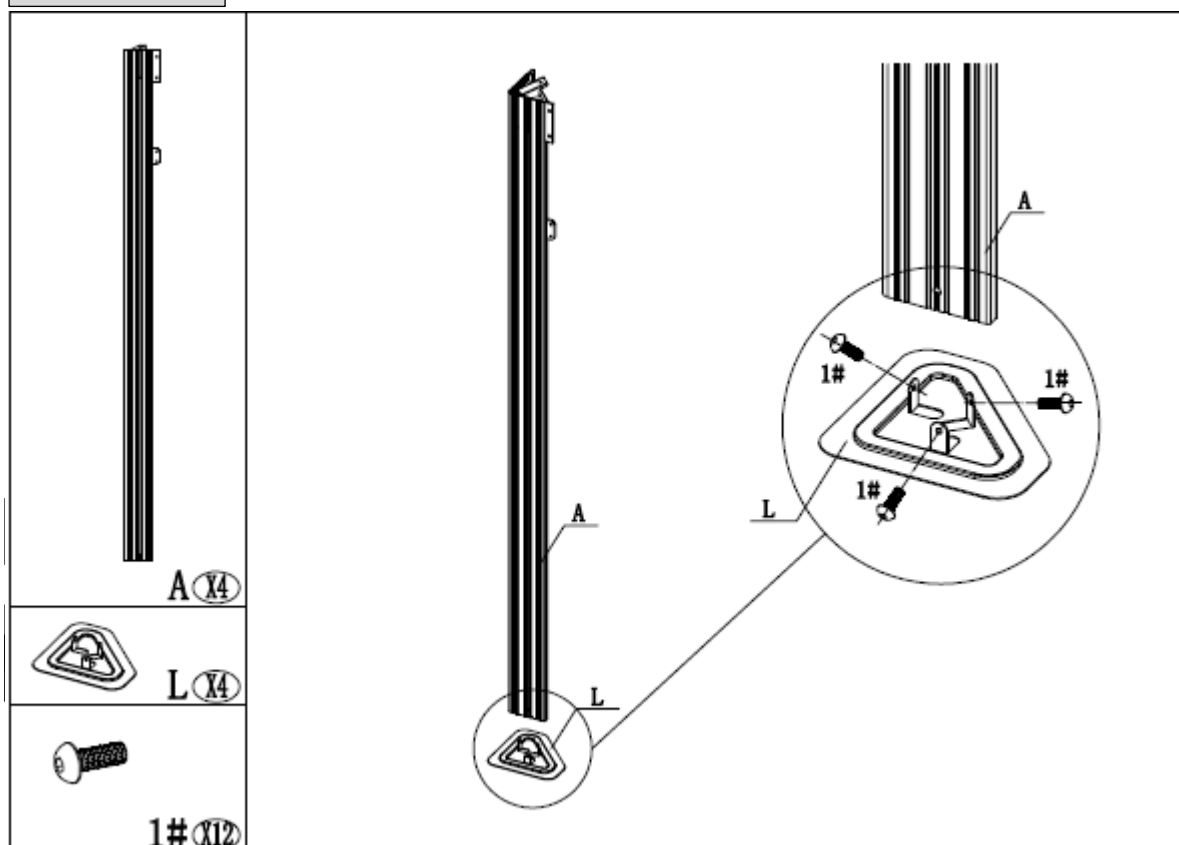

SCHRITT 3

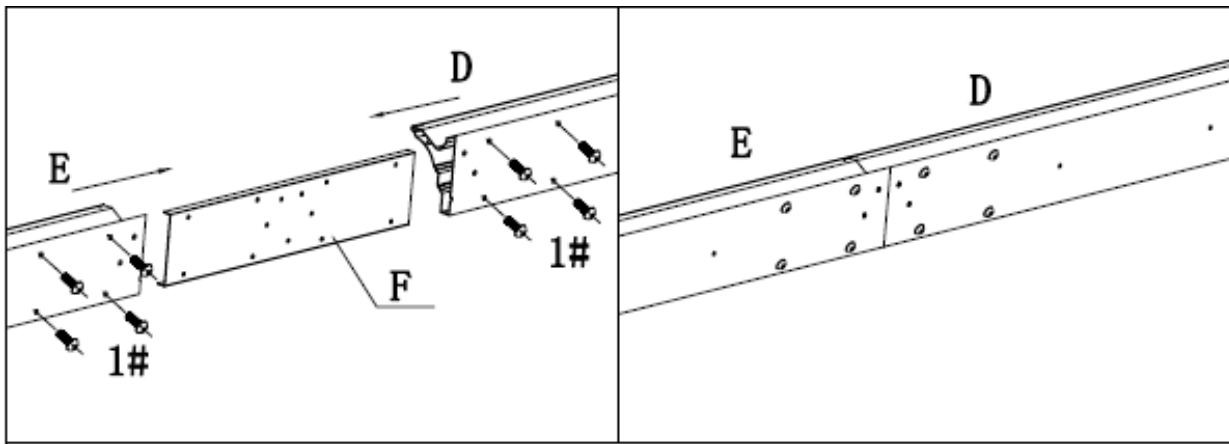
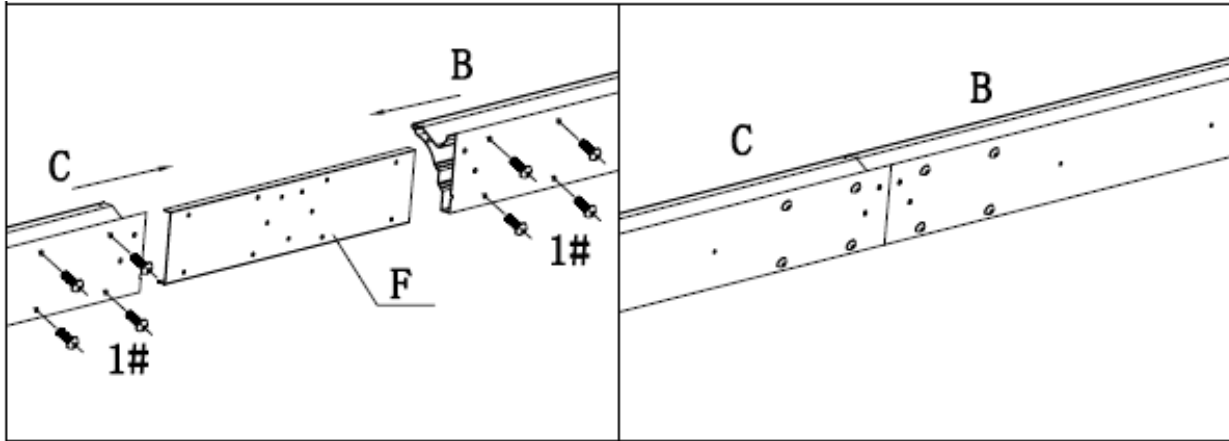
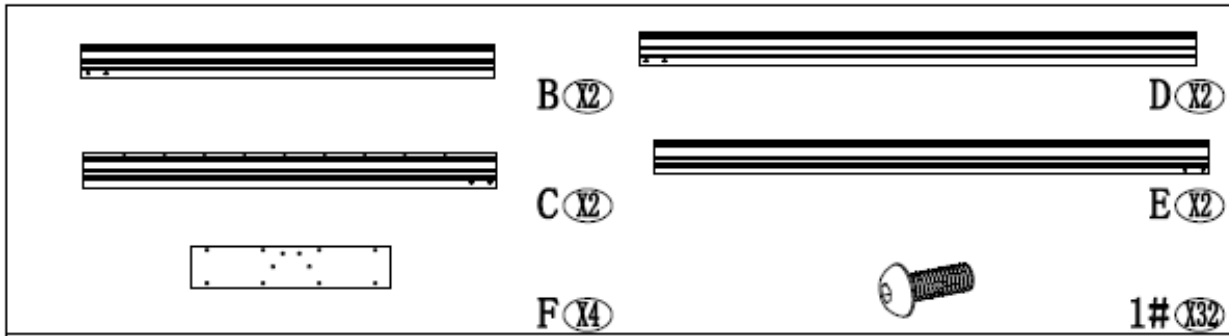

SCHRITT 4

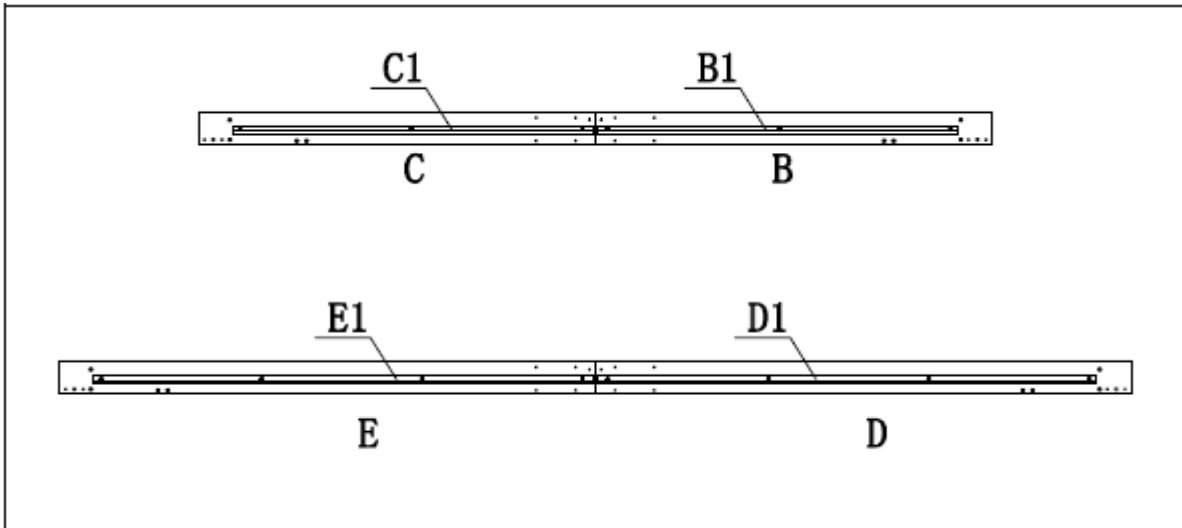
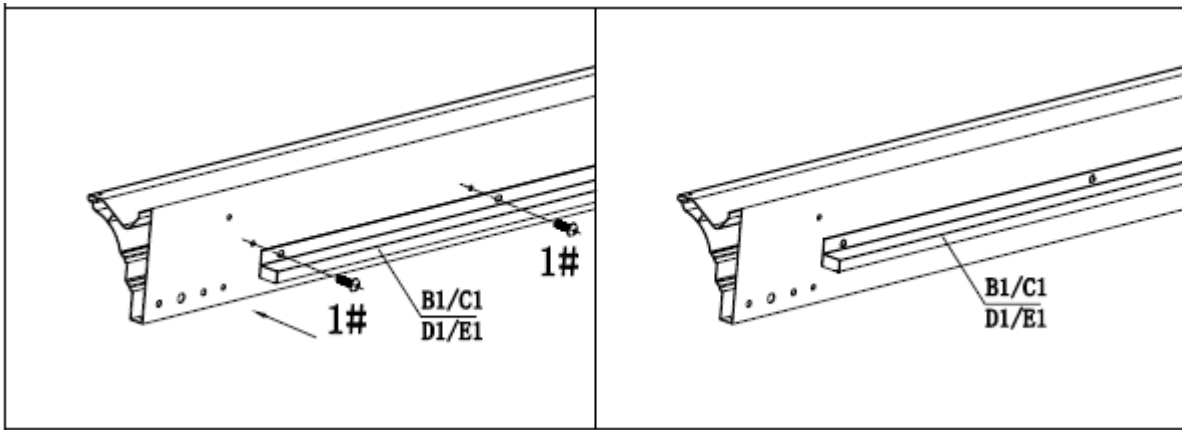
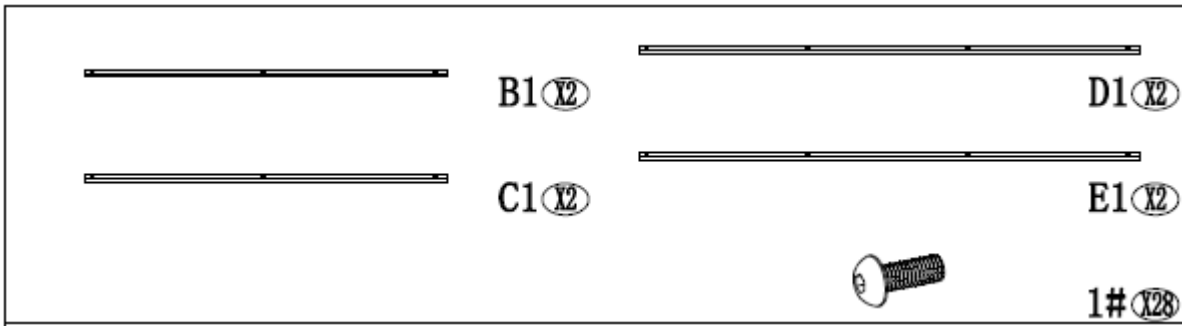

SCHRITT 5

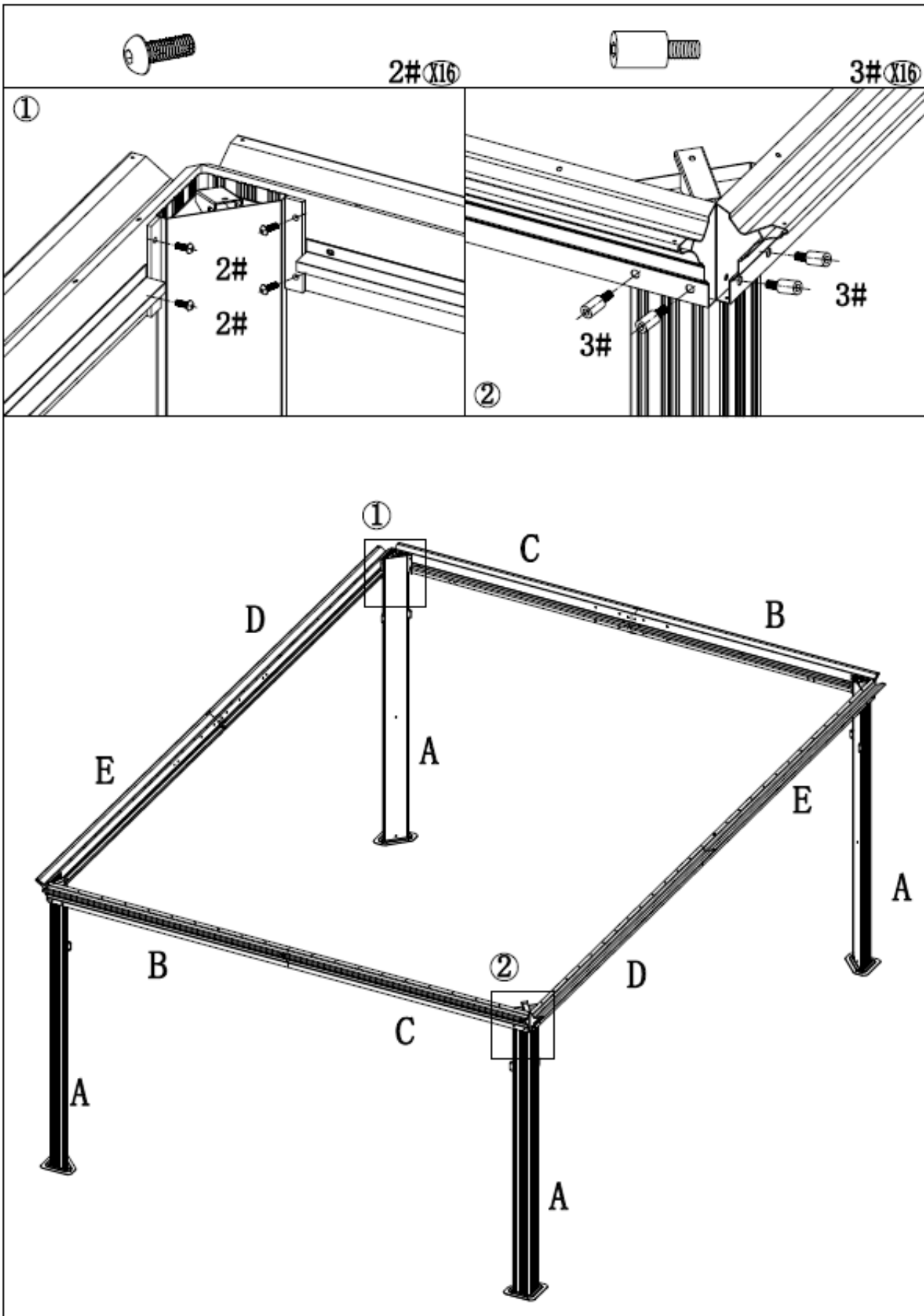

SCHRITT 6

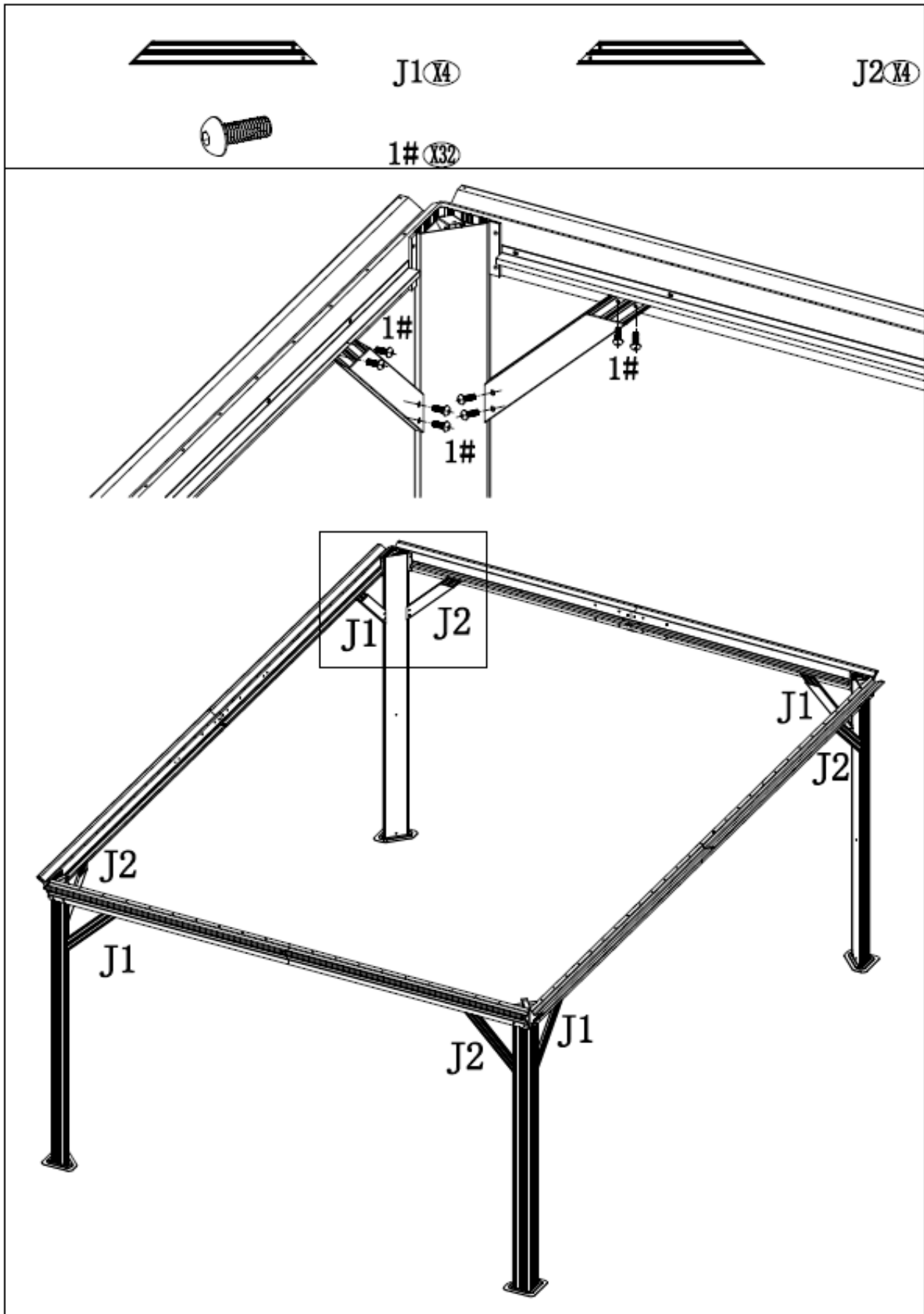

SCHRITT 7

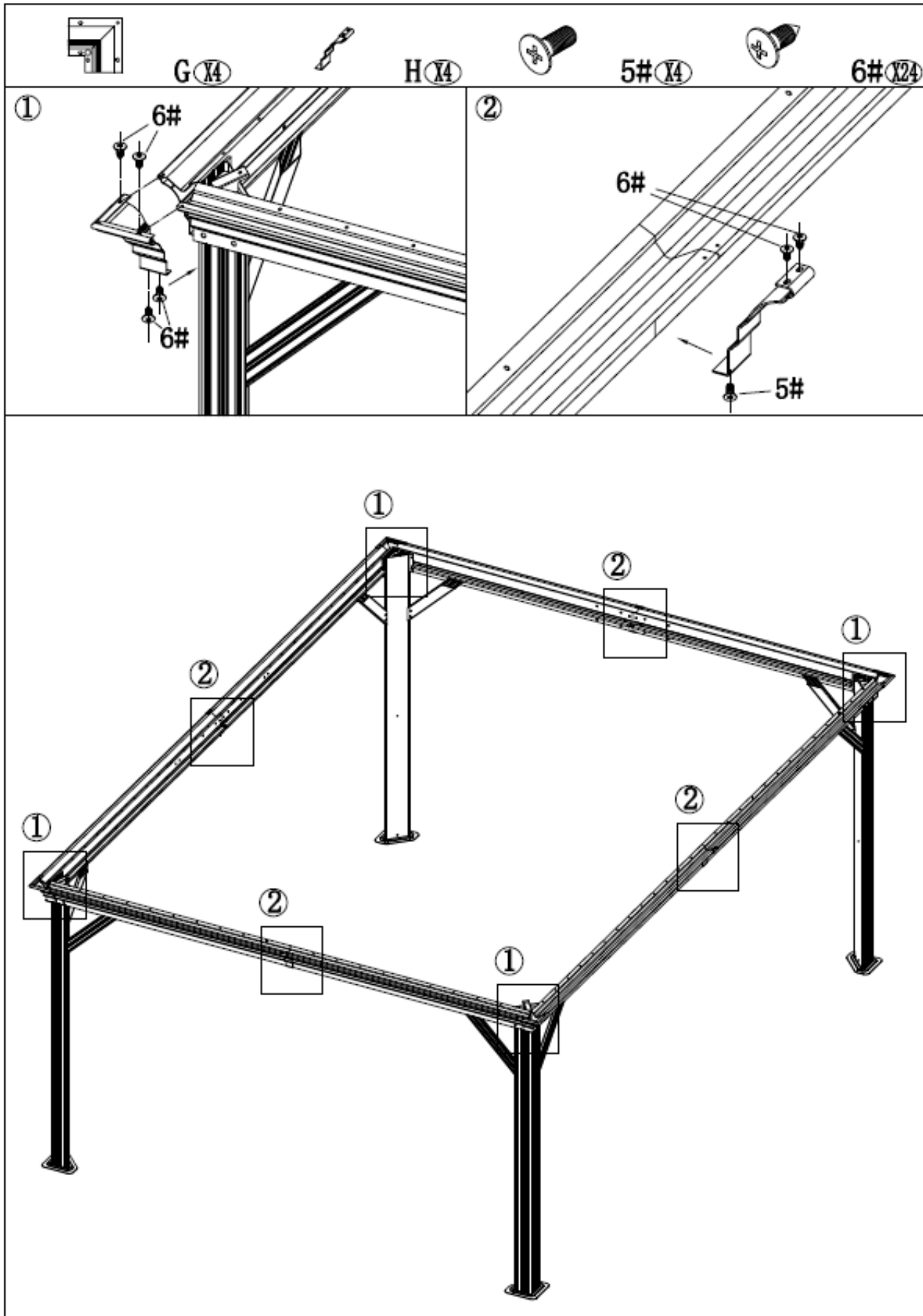

SCHRITT 8

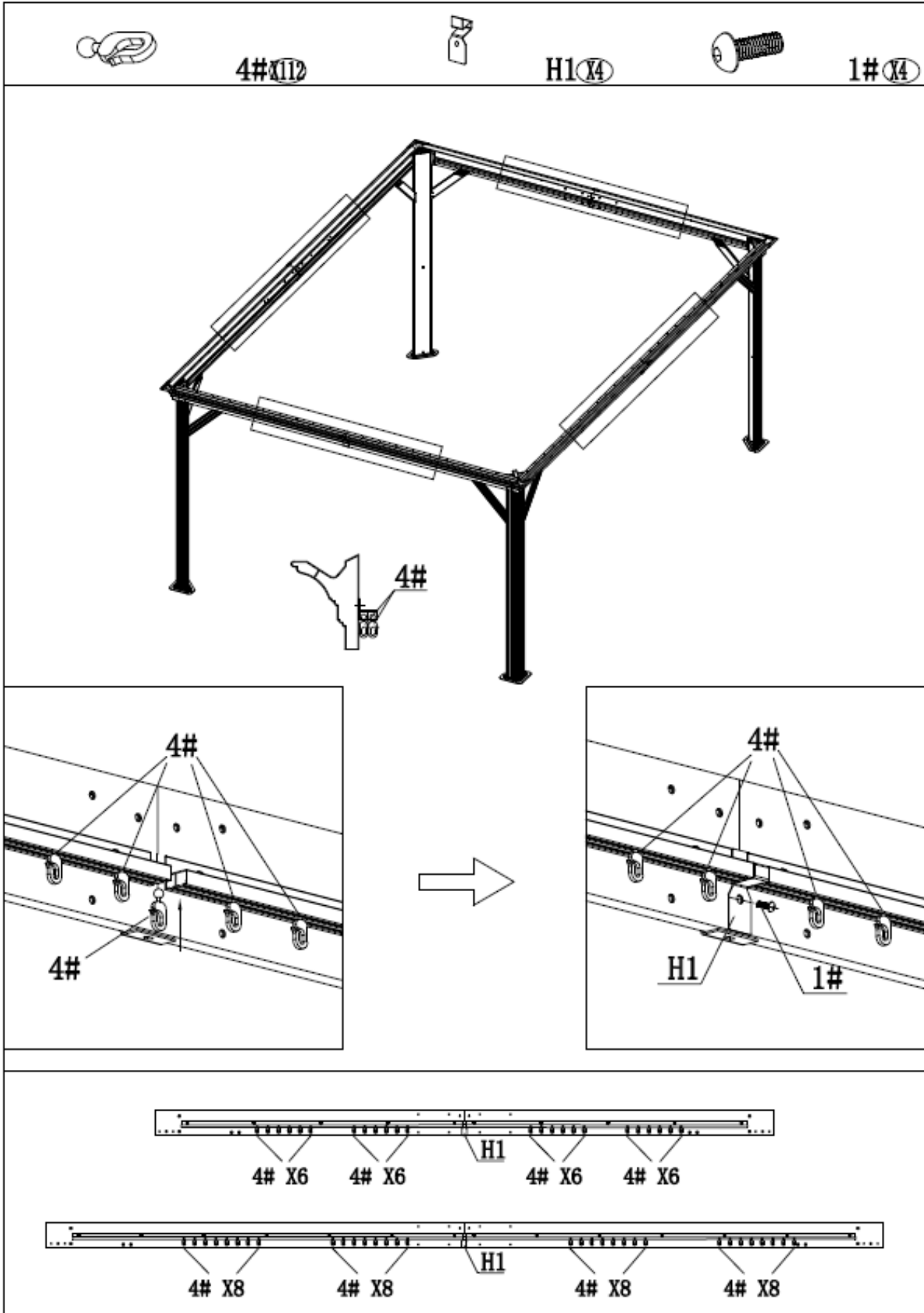

SCHRITT 9

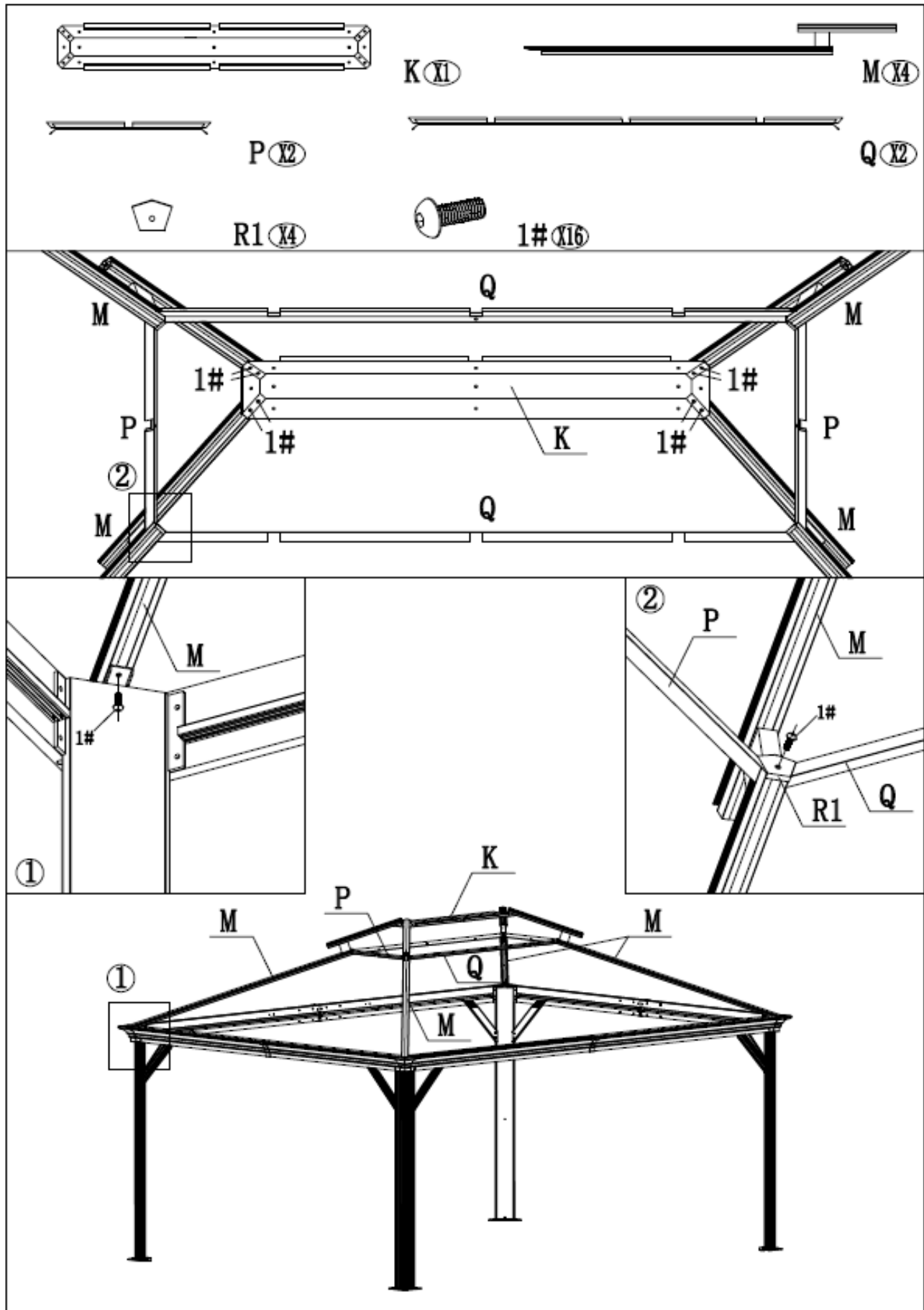

SCHRITT 10

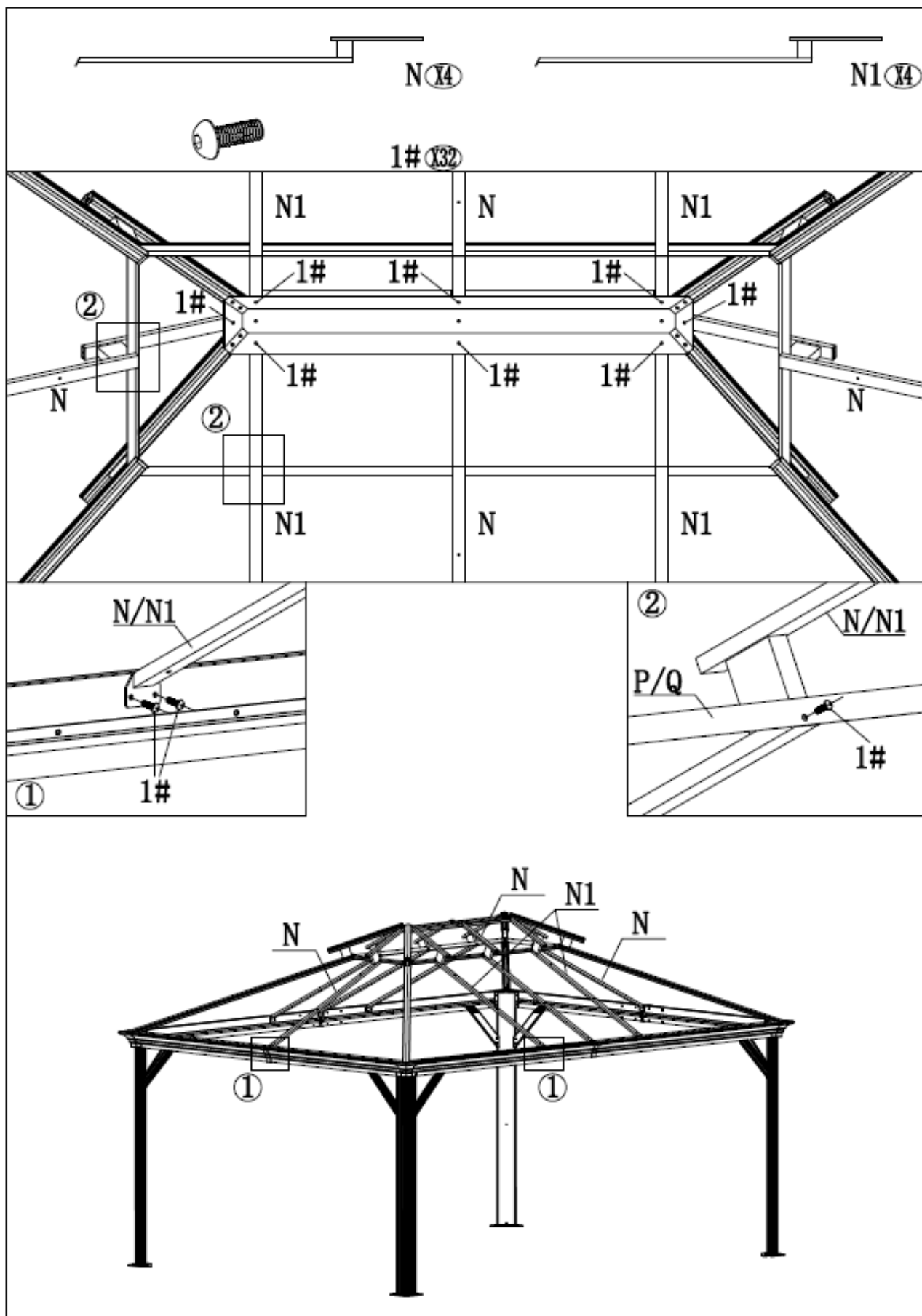

SCHRITT 11

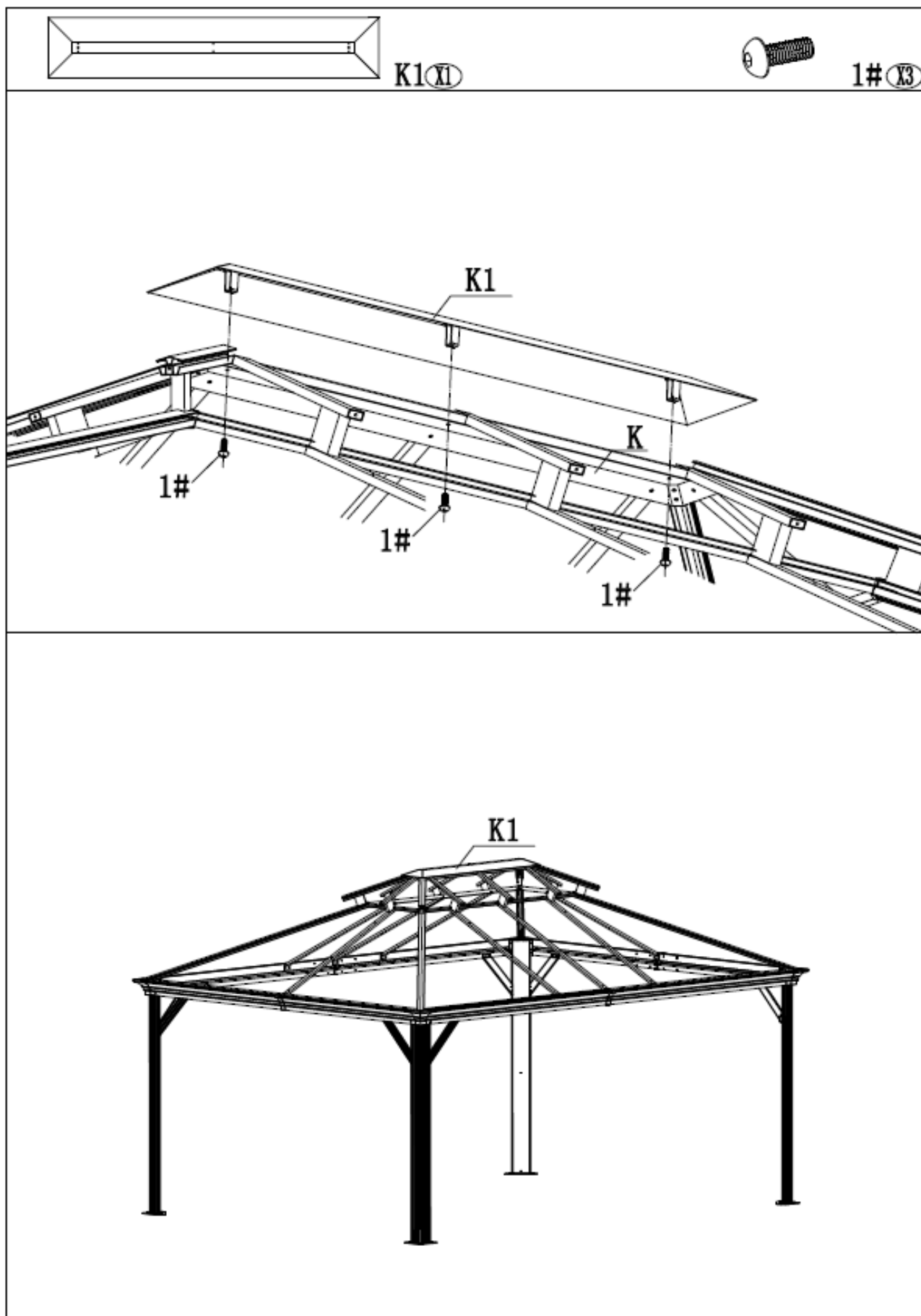

SCHRITT 12

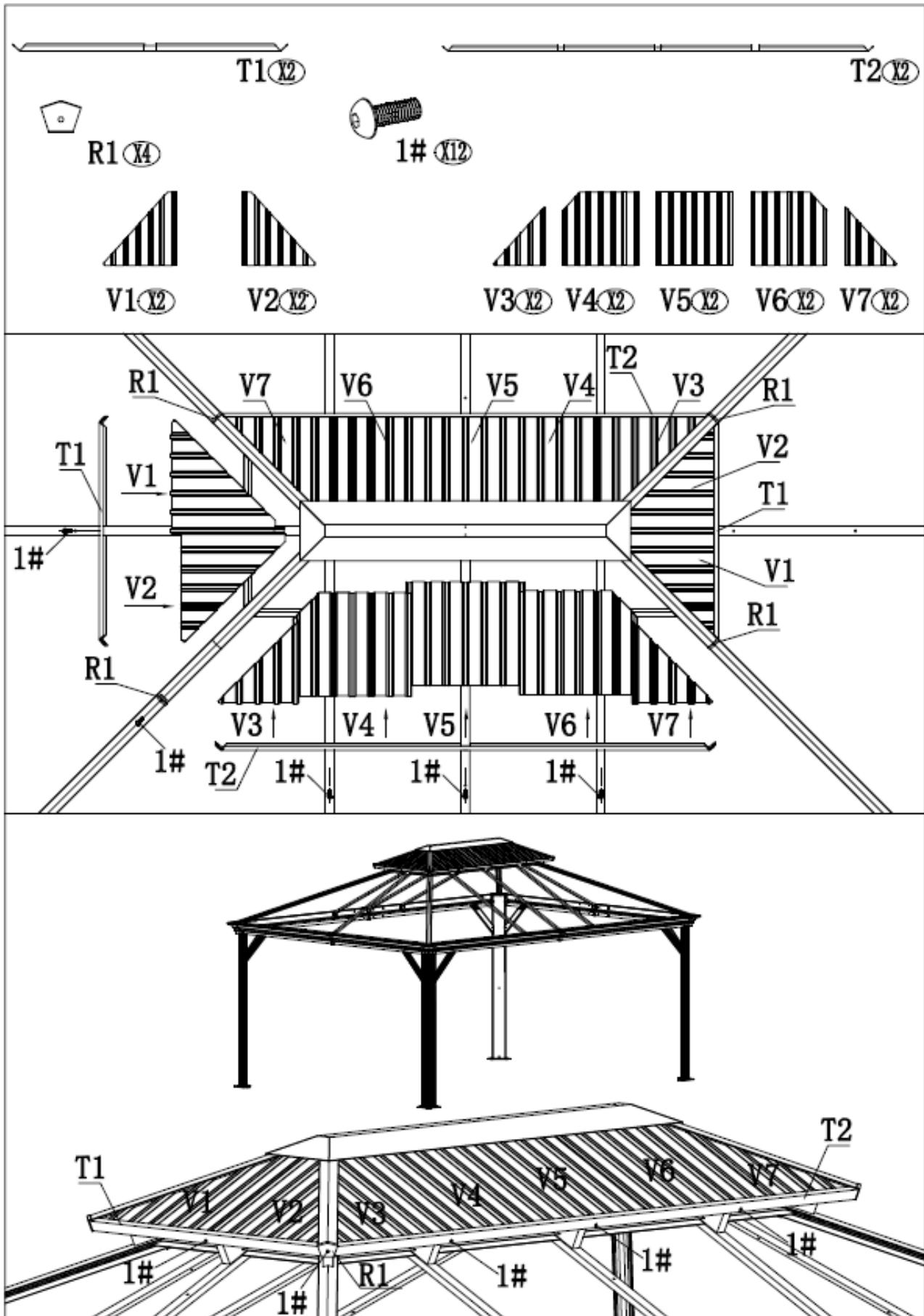

SCHRITT 13

	U1 (X4)		U5 (X8)
	U2 (X4)		U6 (X4)
	U3 (X2)		1# (X36)
	U4 (X2)		

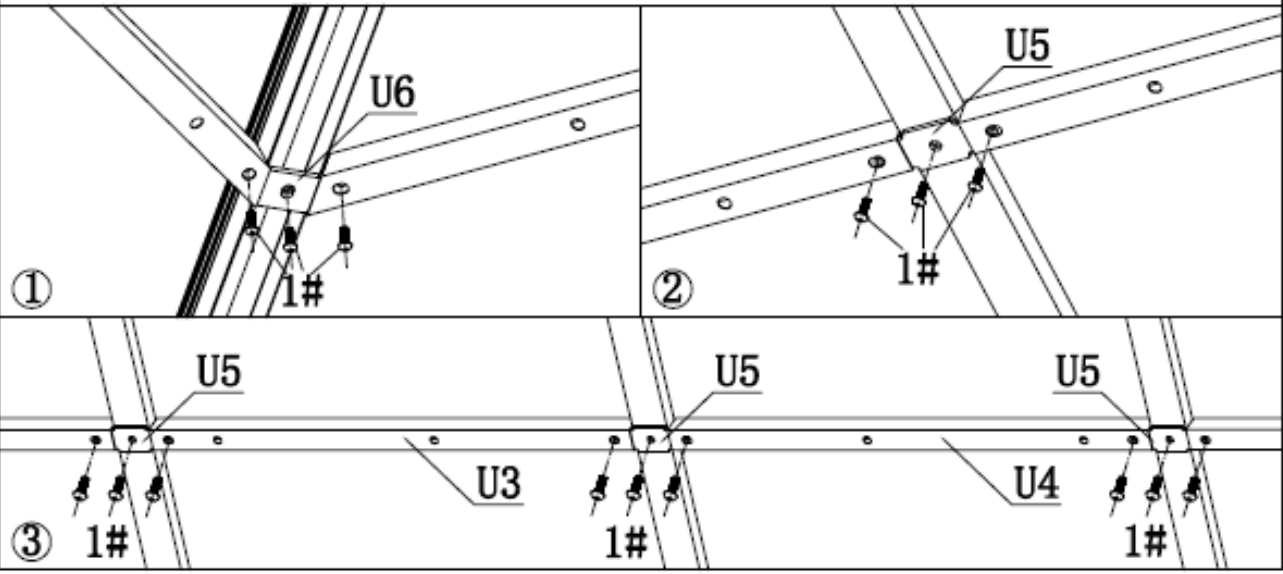
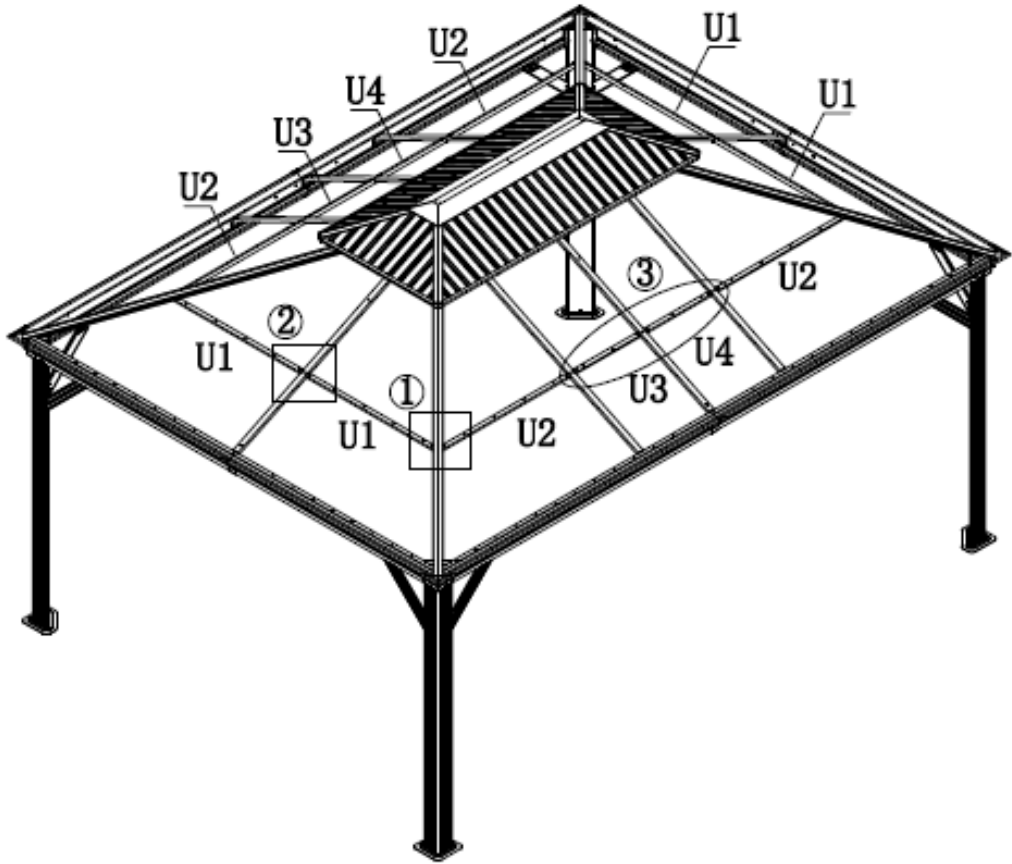

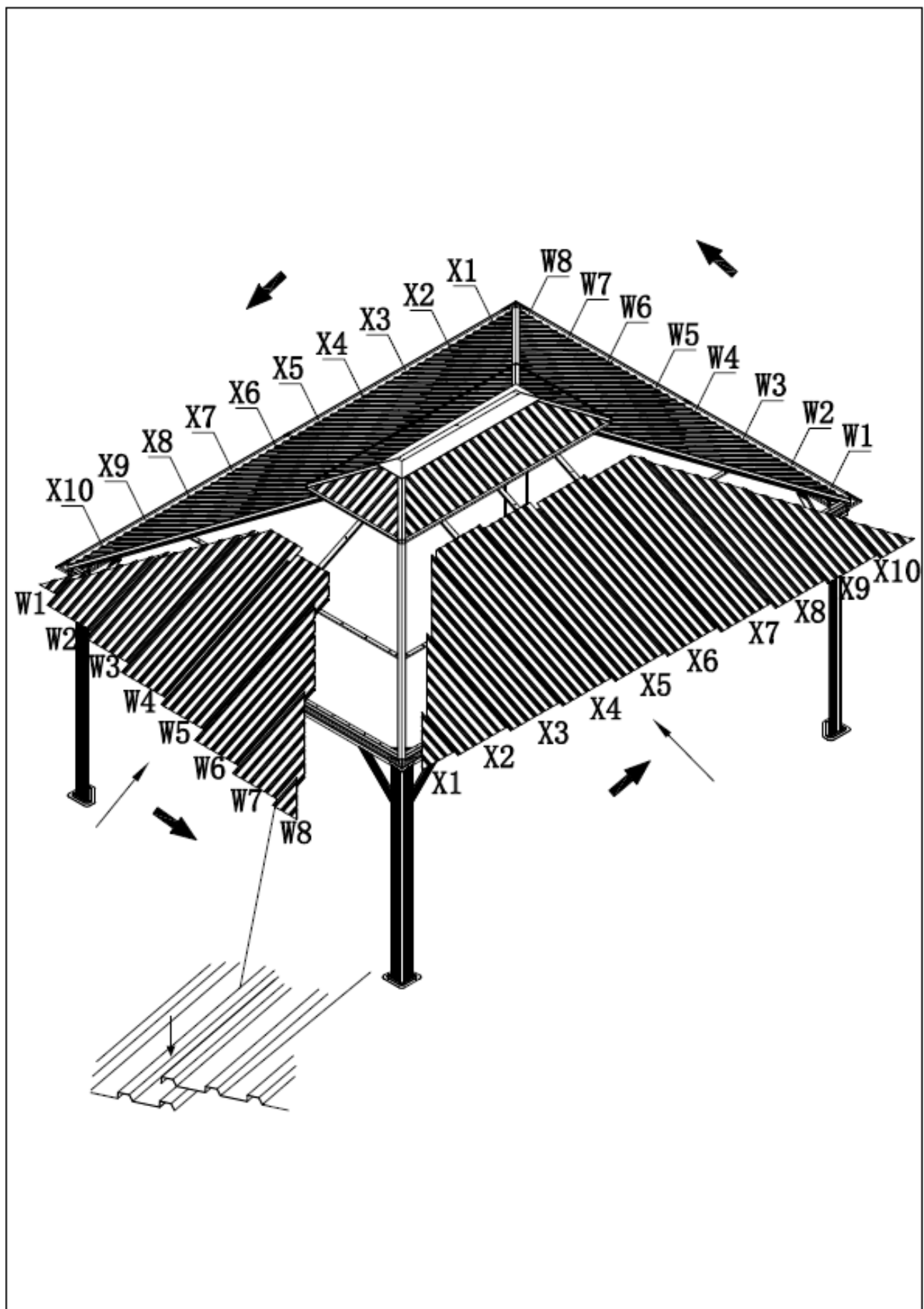

SCHRITT 15

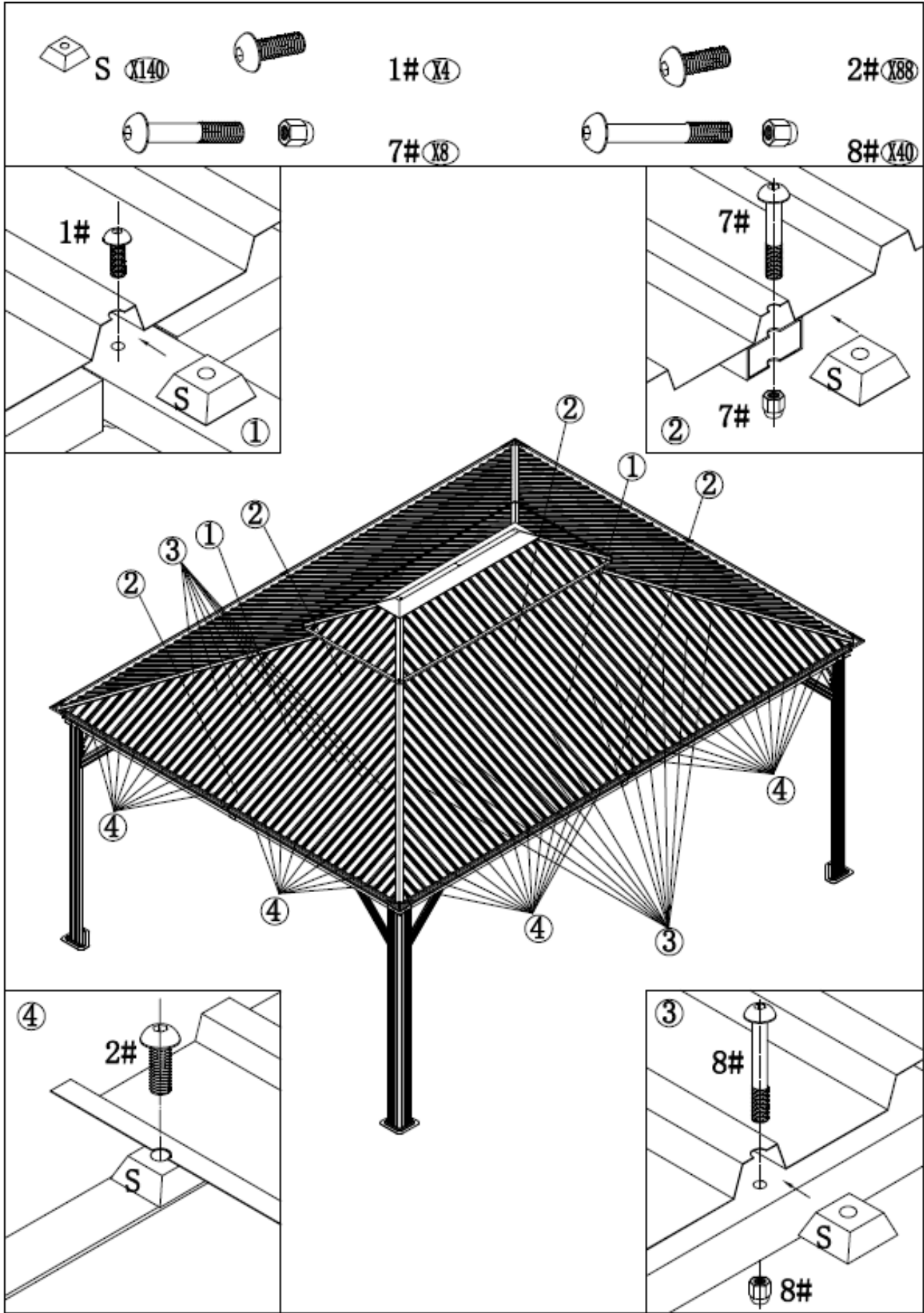

SCHRITT 16

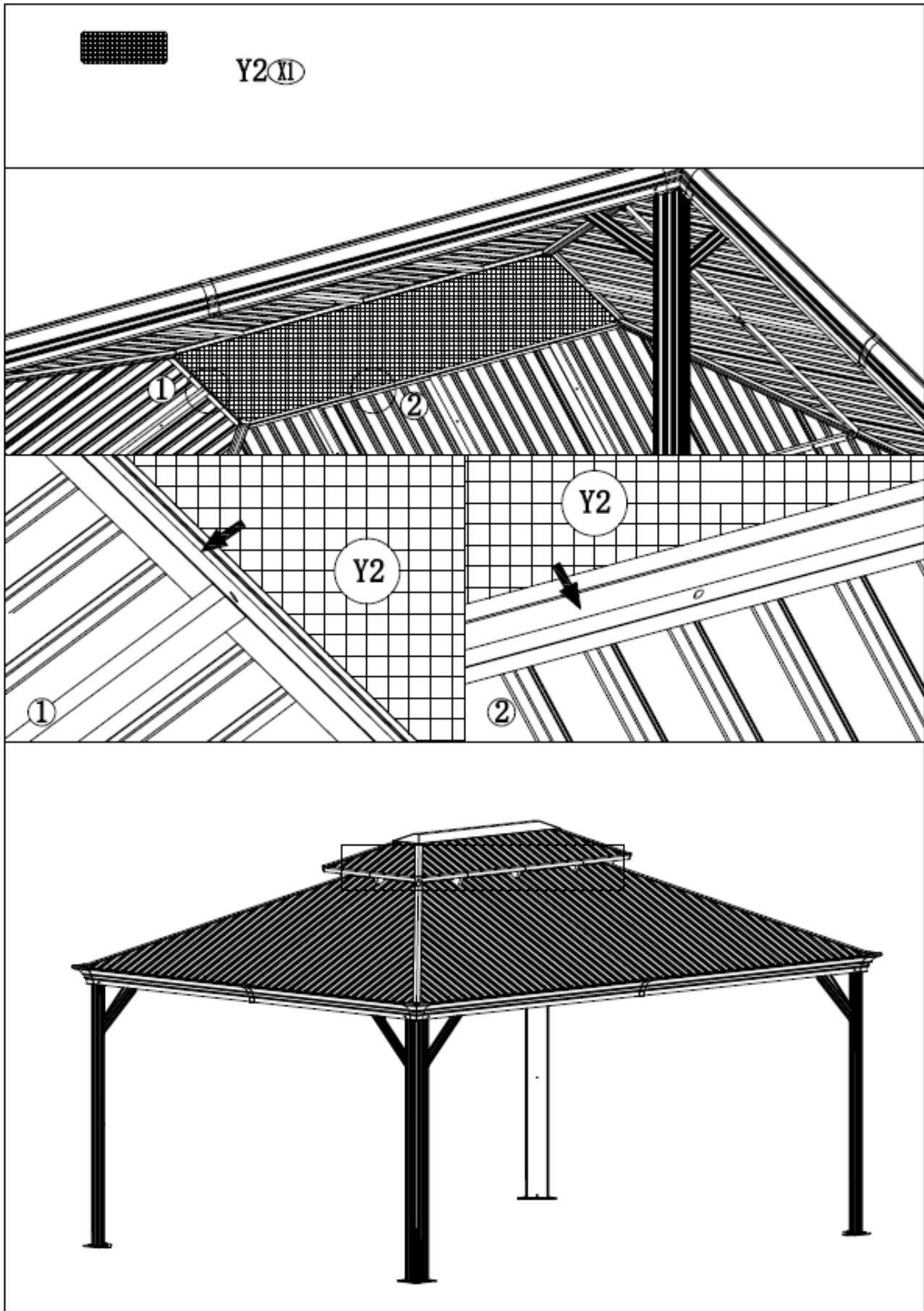

SCHRITT 17

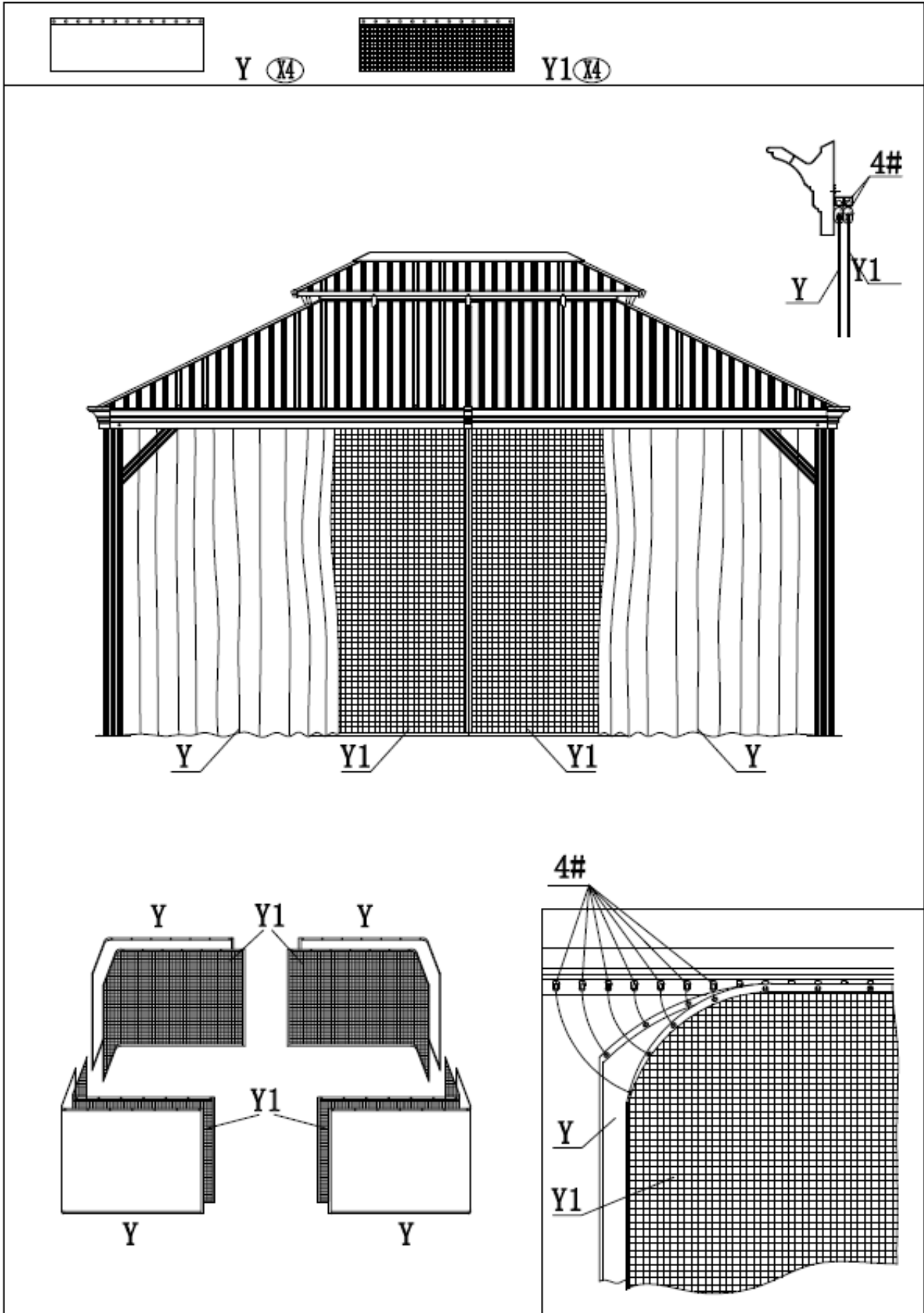

SCHRITT 18

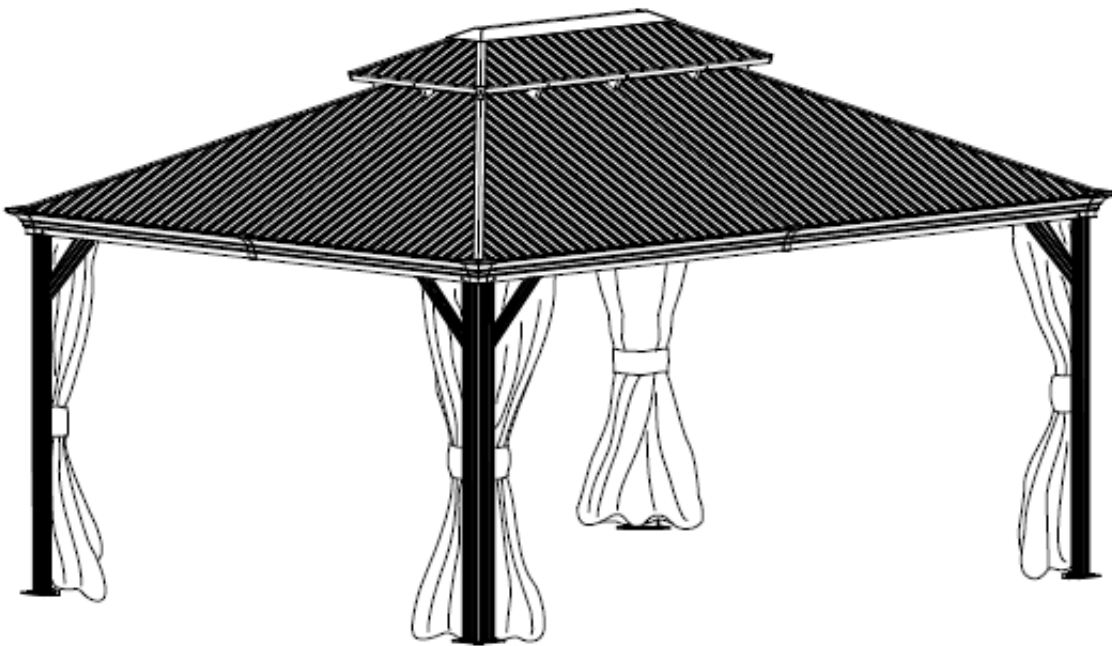
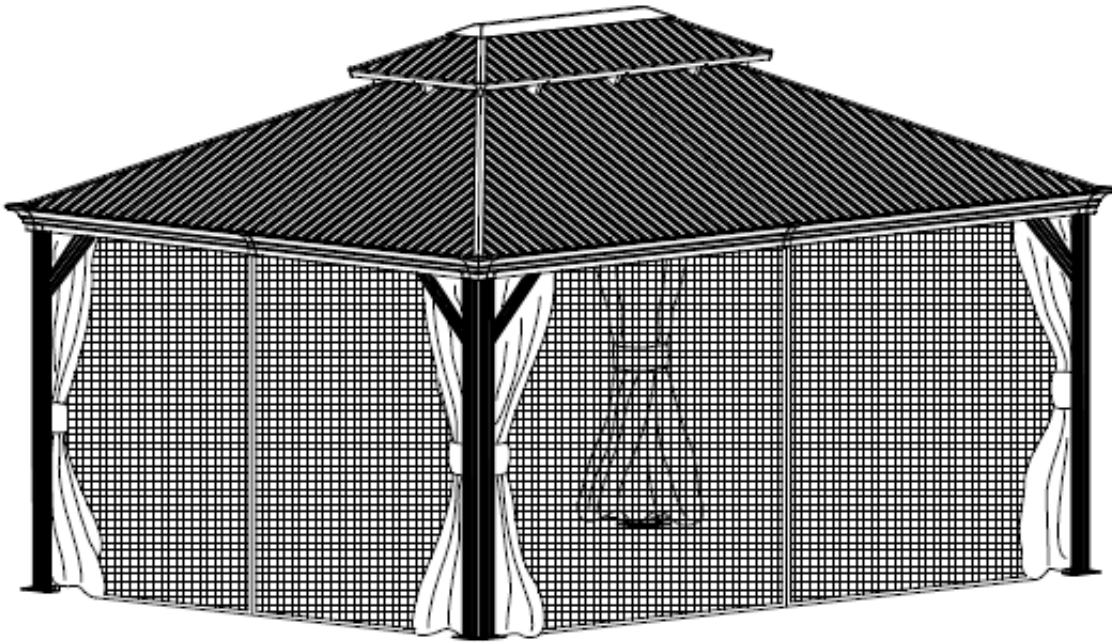



Installationsvideos und Aufbauanleitungen
zu unseren Produkten finden Sie
in unserem Shop beim jeweiligen Produkt

Weitere Produkte für Haus und Garten
finden Sie unter
www.jet-line.de

Jet-Line
group

KBW Trading GmbH
Gewerbering 2
88518 Herbertingen
Deutschland
Tel: 07586-921160
Fax: 07586-9211616
E-Mail: info@jet-line.de
www.jet-line.de

Jet-Line
group