



GARTENPAVILLON „HEAVEN II“

Artikel-Nr.: 2198

300 x 300 x 240 cm

- AUFBAUANLEITUNG -



Installationsvideos und Aufbauanleitungen

zu unseren Produkten finden Sie unter

www.gartenmoebelkauf.de

Nutzername: jet-line • Passwort: user2011

Weitere Produkte für Ihren Garten

finden Sie unter

www.gartenmoebelkauf.de











Produkt-Code:











2198

Produkt-Maße:

ca. 300 X 300 X 240 cm

Teile-Liste:

Nr.	Abb.	Stz.
A		4x
E	M6 	2x
G		1x
I	M6x15 	32x
K	M6x35 	16x
M	M4 	2x
P		2x
R		36x
U		16x
W		2x
Y		2x

Nr.	Abb.	Stz.
D	M6 	2x
F		2x
H		2x
J	M6x60 	2x
L		2x
N		2x
Q		1x
T		4x
V		4x
X		50x
Z		16x

Aufbau-Anleitung:

SCHRITT 1

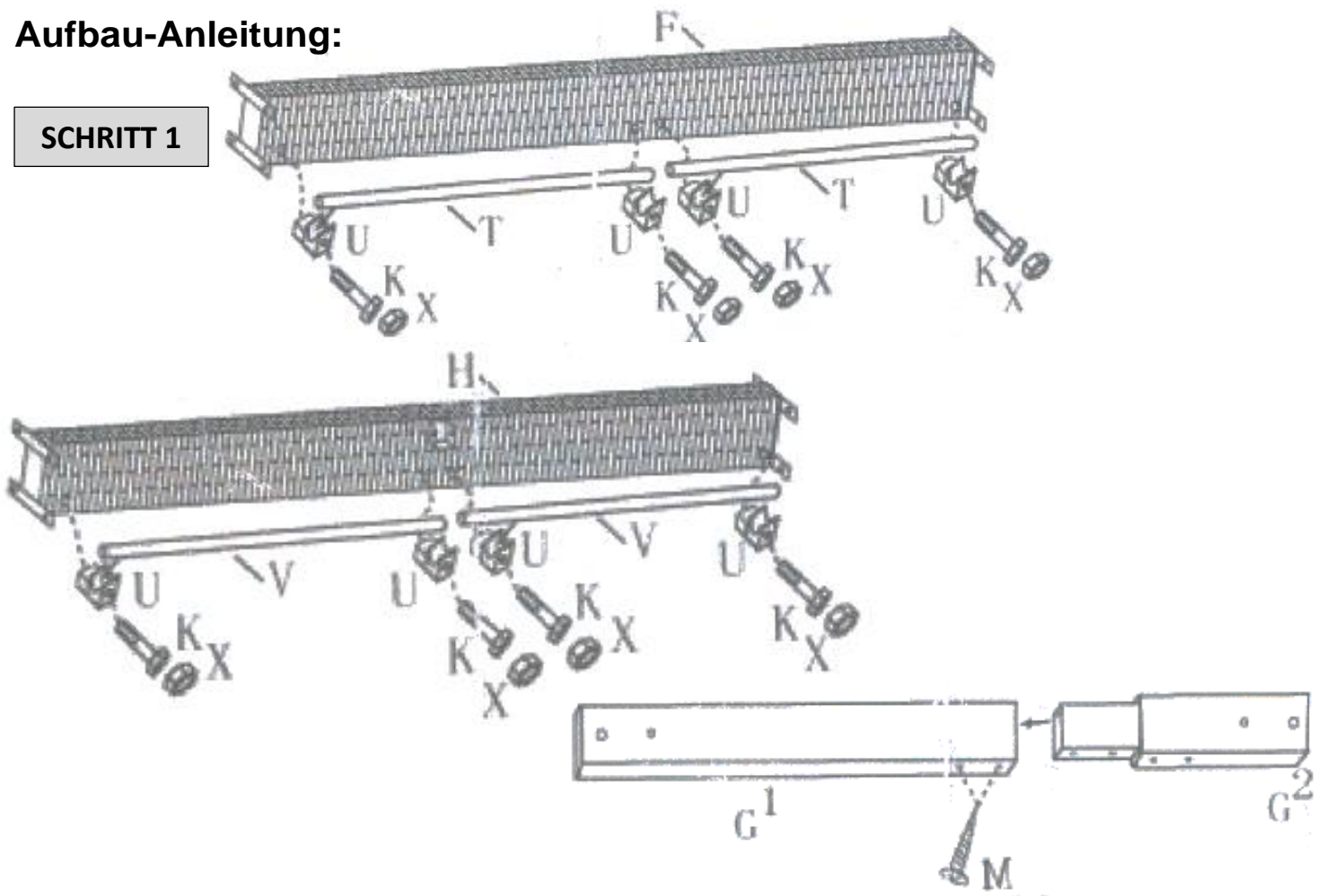

SCHRITT 2

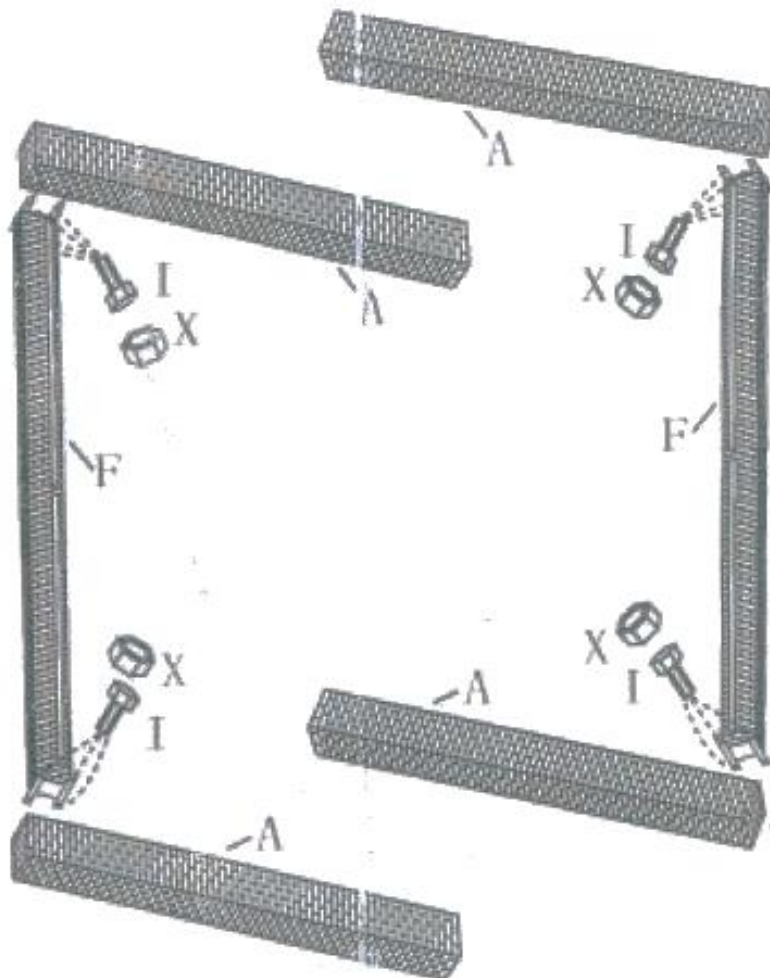

SCHRITT 3

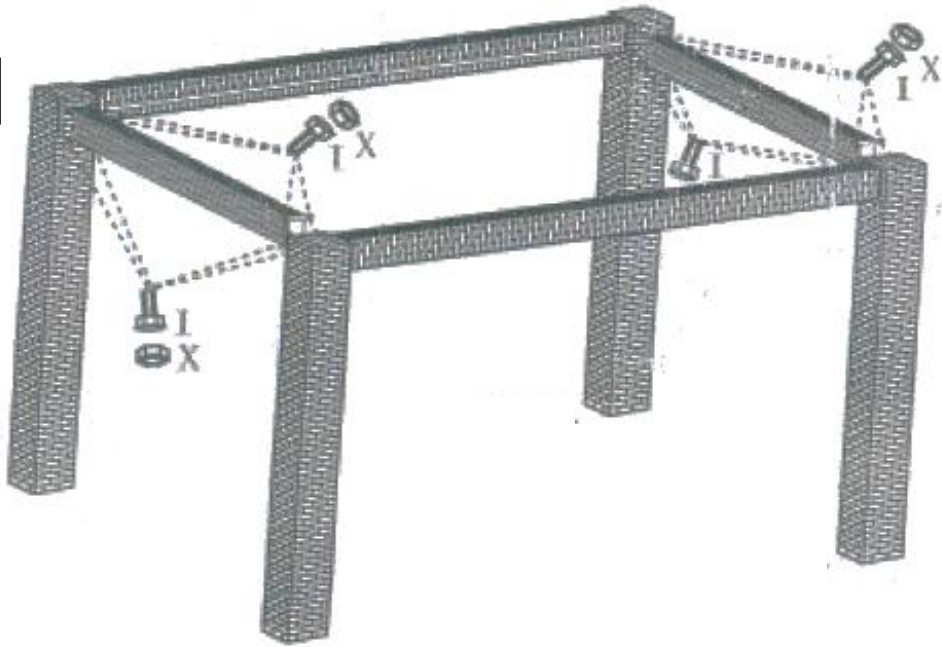

SCHRITT 4

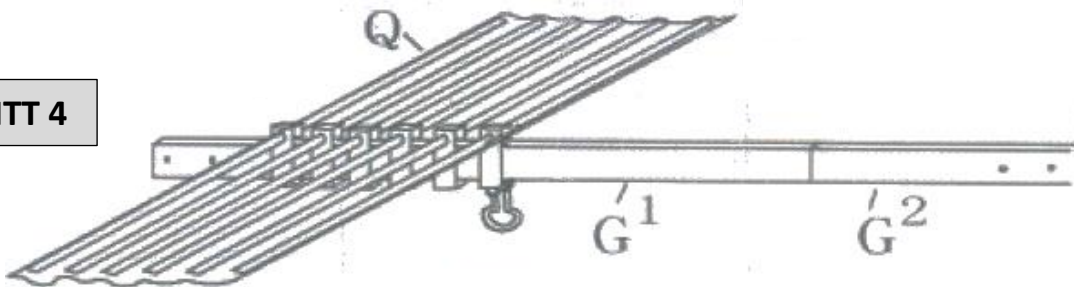

SCHRITT 5

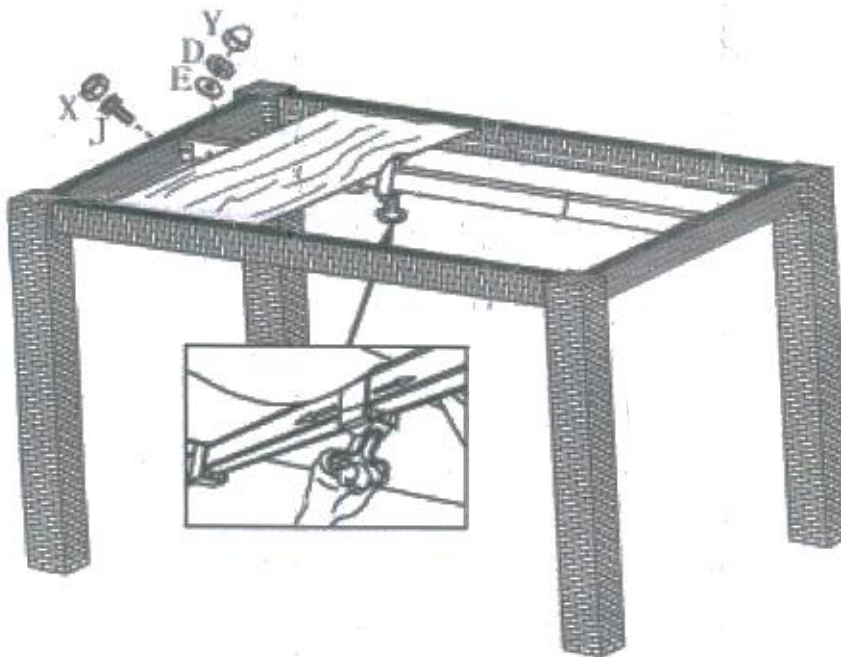

SCHRITT 6

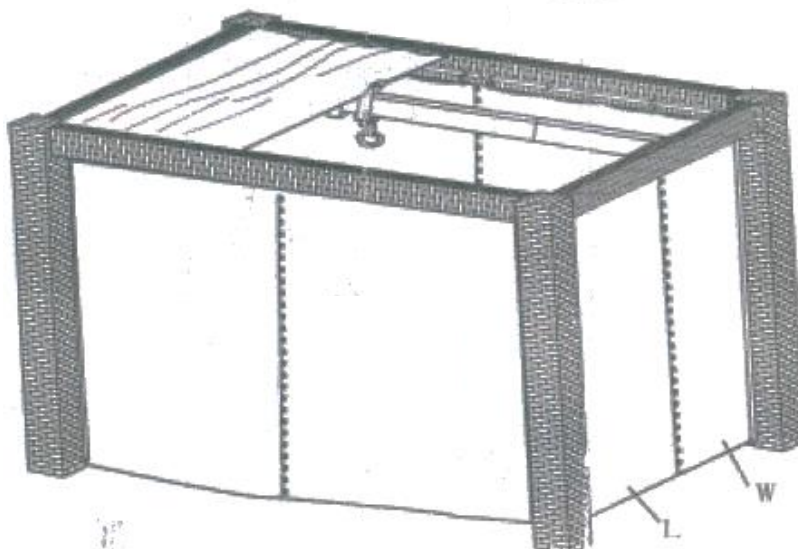

Installationsvideos und Aufbauanleitungen

zu unseren Produkten finden Sie unter

www.gartenmoebelkauf.de

Nutzername: jet-line • Passwort: user2011

Weitere Produkte für Ihren Garten

finden Sie unter

www.gartenmoebelkauf.de



KBW Trading GmbH

Gewerbering 2

88518 Herbertingen

Deutschland

Tel: 07586-921160

Fax: 07586-9211616

E-Mail: info@jet-line.de

www.gartenmoebelkauf.de