



## **GARTENPAVILLON „LUXOR“**

Artikel-Nr.: 2331 (anthrazit) + 2826 (beige)

400 x 300 x 220 cm

- AUFBAUANLEITUNG -



**Installationsvideos und Aufbauanleitungen**

zu unseren Produkten finden Sie unter

[www.gartenmoebelkauf.de](http://www.gartenmoebelkauf.de)





Nutzername: jet-line • Passwort: user2011





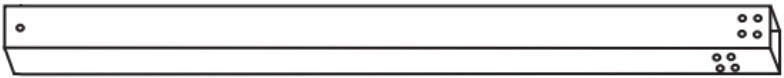
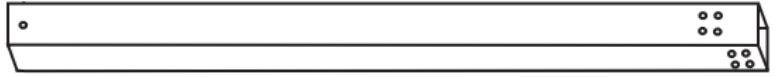
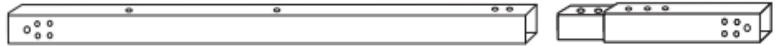
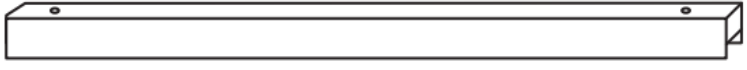
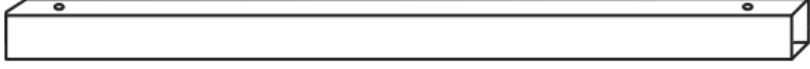

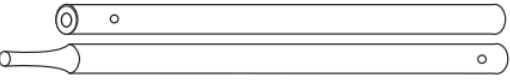
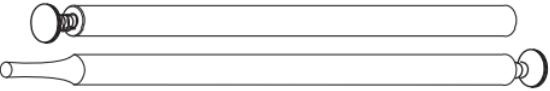
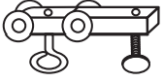
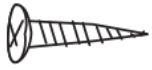

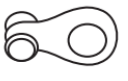
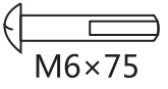

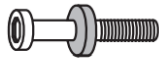
**Weitere Produkte für Ihren Garten**

finden Sie unter

[www.gartenmoebelkauf.de](http://www.gartenmoebelkauf.de)

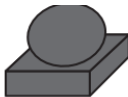
## Teile-Liste

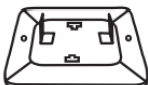
Nr.	Abb.	Bezeichnung	Stz.
A		Standsäule A 2826E018	2
B		Standsäule B 2826E001	2
C		Oberer Rahmenverbinder 2826E013	1
D		Mittlere Laufschiene 2826E002	1
D1		Querverbinder 2826E012	2
E		Oberer Rahmenverbinder 2836E003	1
F		Oberer Rahmenverbinder F 2826E009	2
G		Äußere Stabi- Stange Stoffdach 2826E004	1
H		Stabi-Stange Stoffdach 2826E005	5
I + J		Rolle I (+ Schraube J) 2331E000	1
K		Schraube	4
L		Rolle L 2331E001	4
M		Rolle M 2331E015	10
N		Rolle N 2331E003	1
O	 M6x75	Schraube M6x75	6

P	 M6x45	Spezierschraube P M6x45 2826E006	32
R	 M6x12	Schraube M6x12	8
S		Inbusschlüssel	1
T		Schraubenzieher	1
U		Stoffdach U 2826E000 / 2331E004	1
V		Endstück 2827E001	14
W		Obere Abdeckung 2826E016	4
X	 M6x30	Schraube M6x30	2
Y		Bodenplatte	4
Z		Bodenanker	8

# Aufbauanleitung

SCHRITT 1

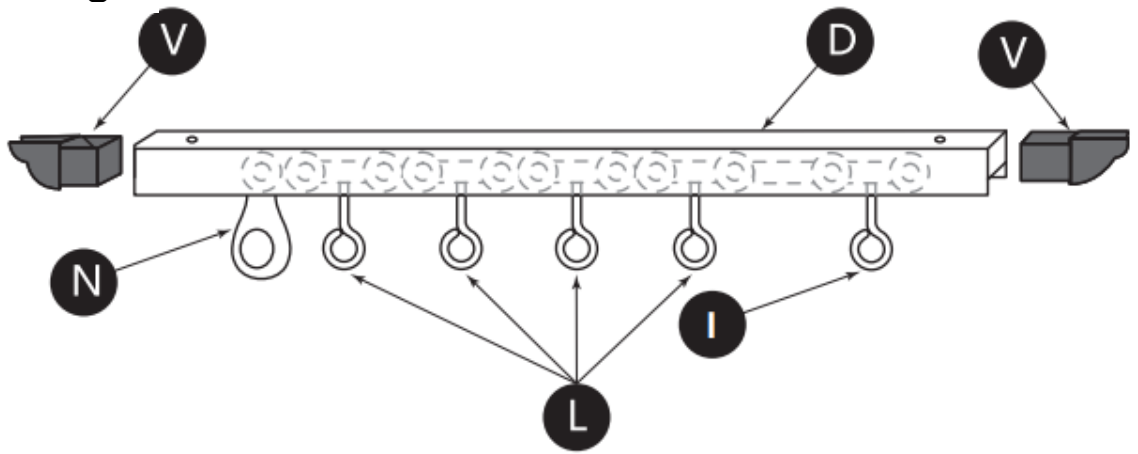

SCHRITT 2

x 2

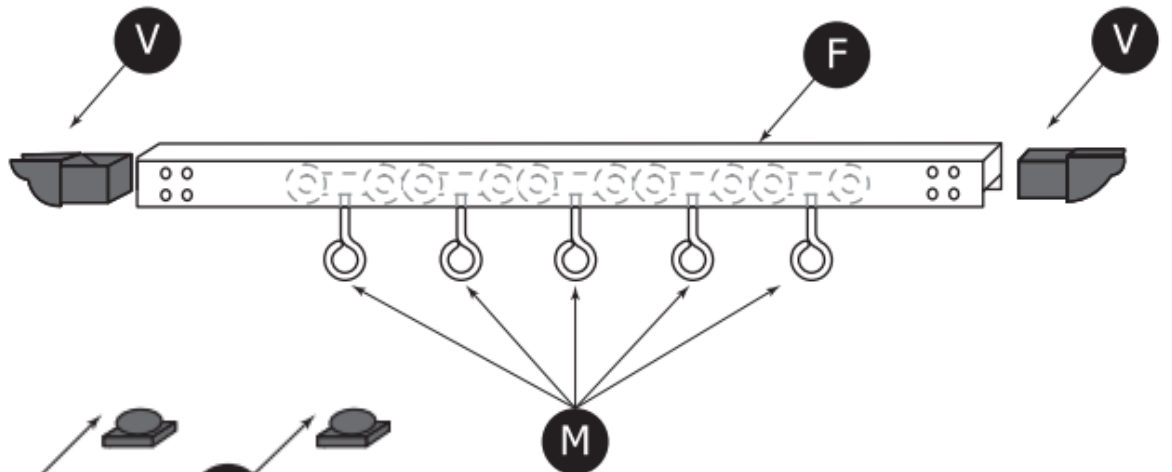

SCHRITT 3

x 2

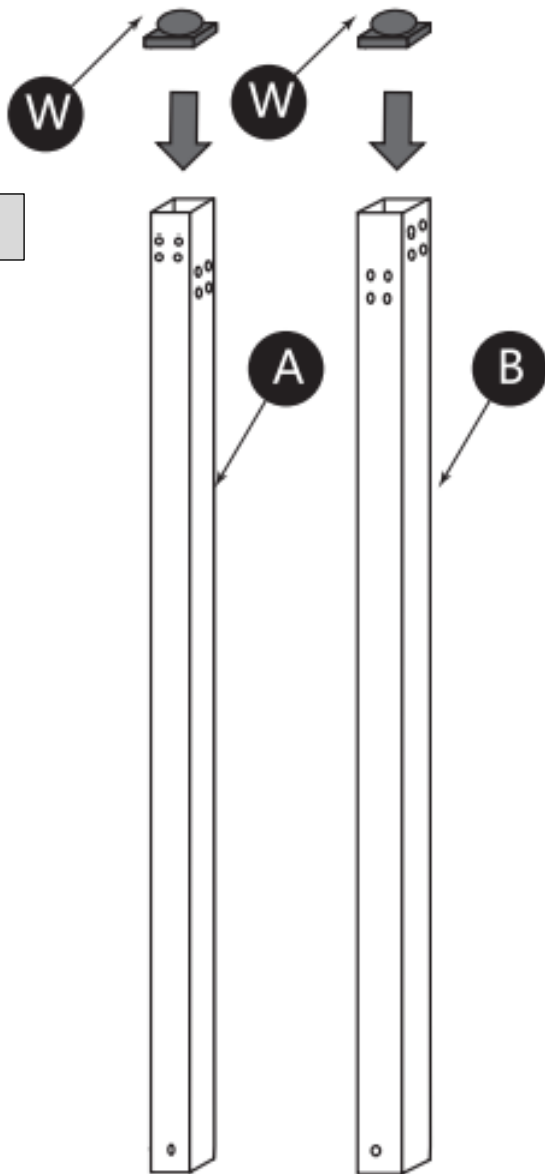

SCHRITT 4

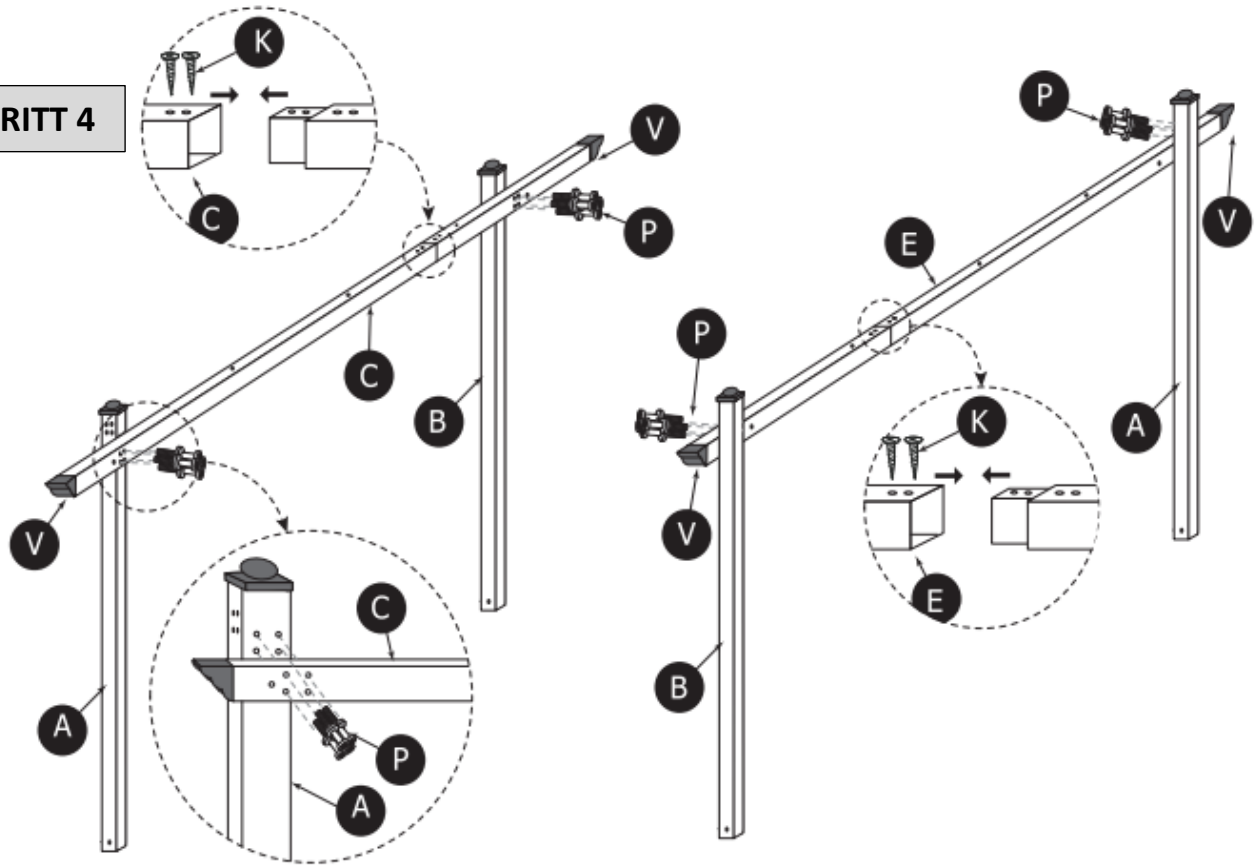

SCHRITT 5

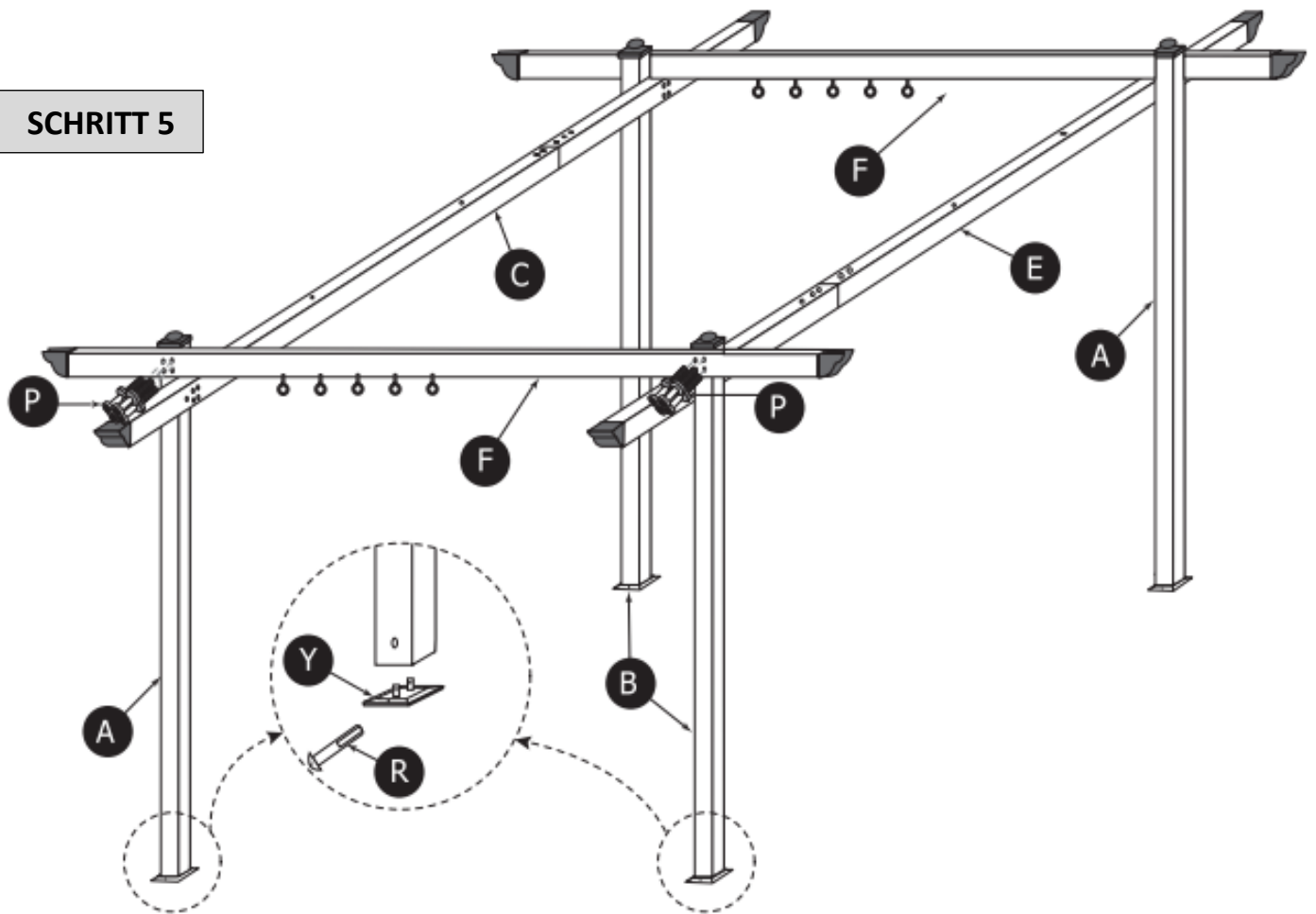

SCHRITT 6

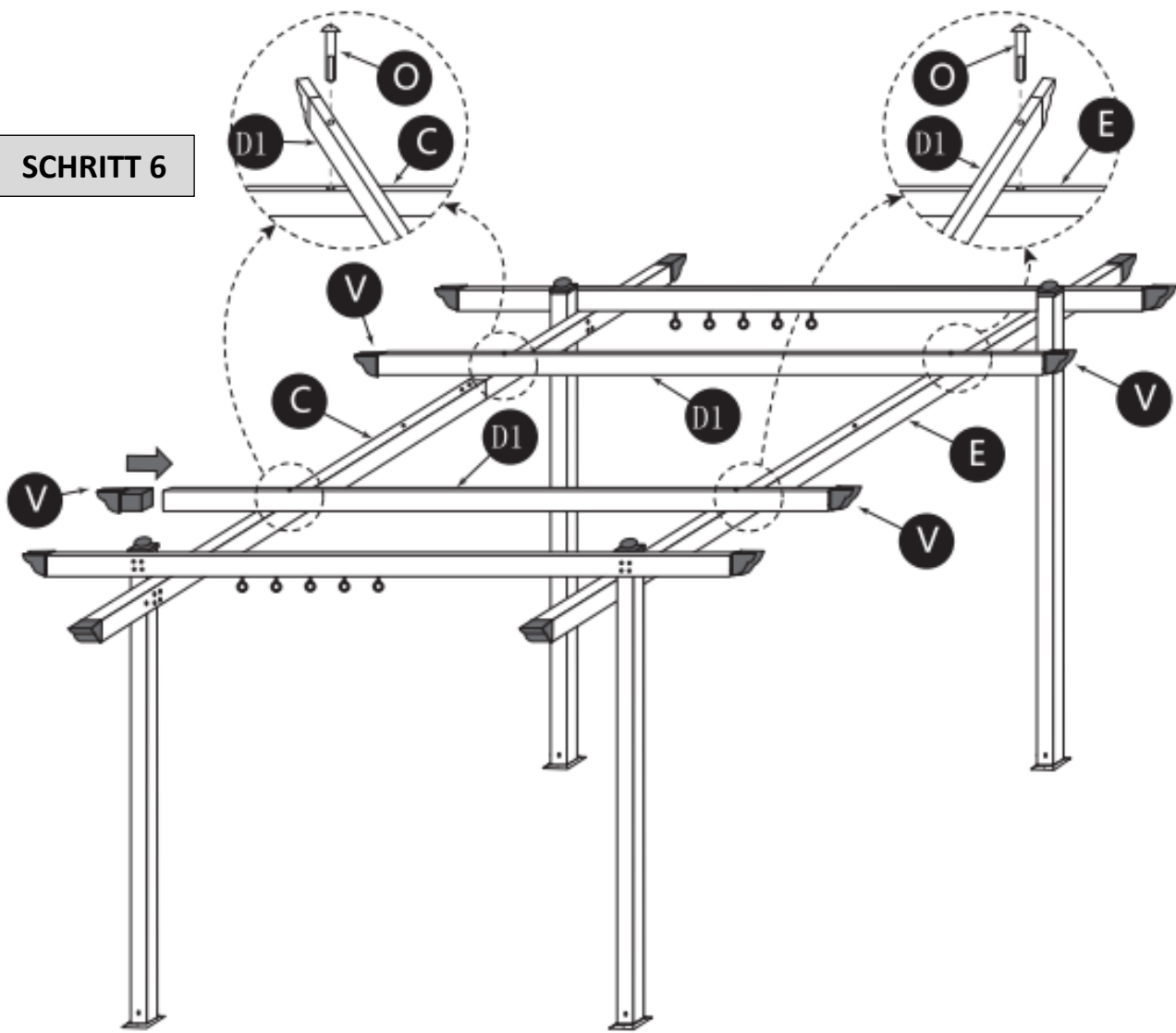

SCHRITT 7

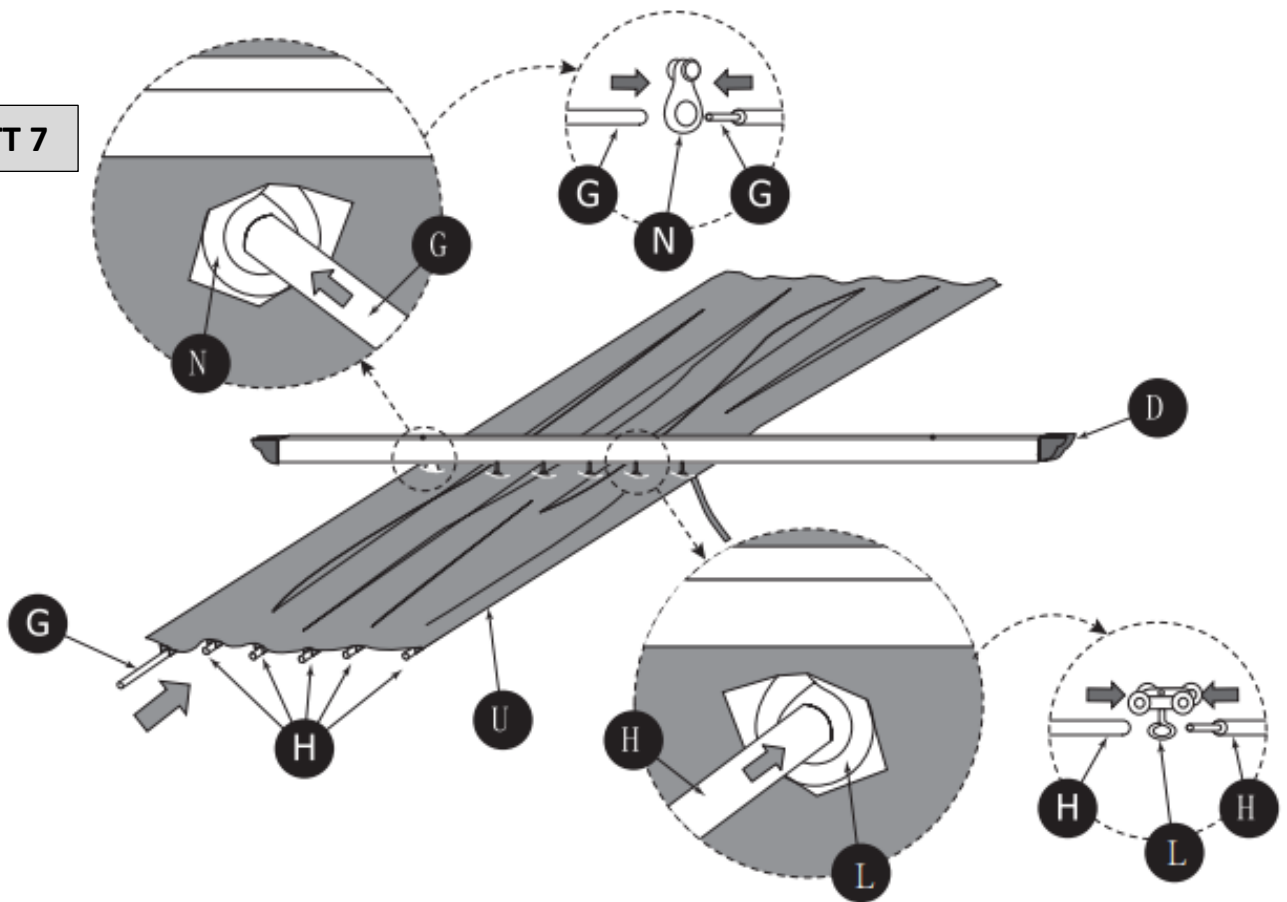

SCHRITT 8

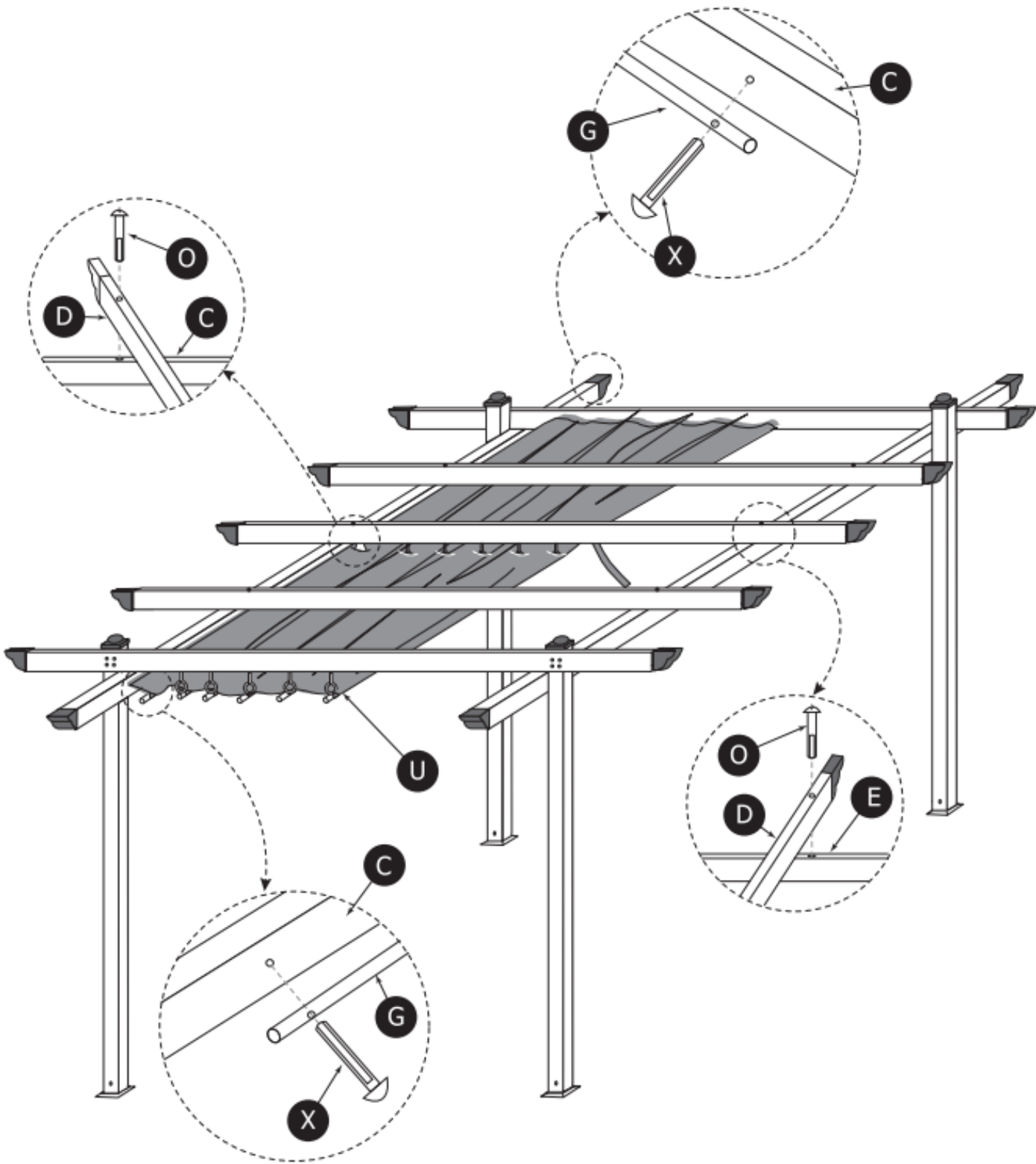

SCHRITT 9

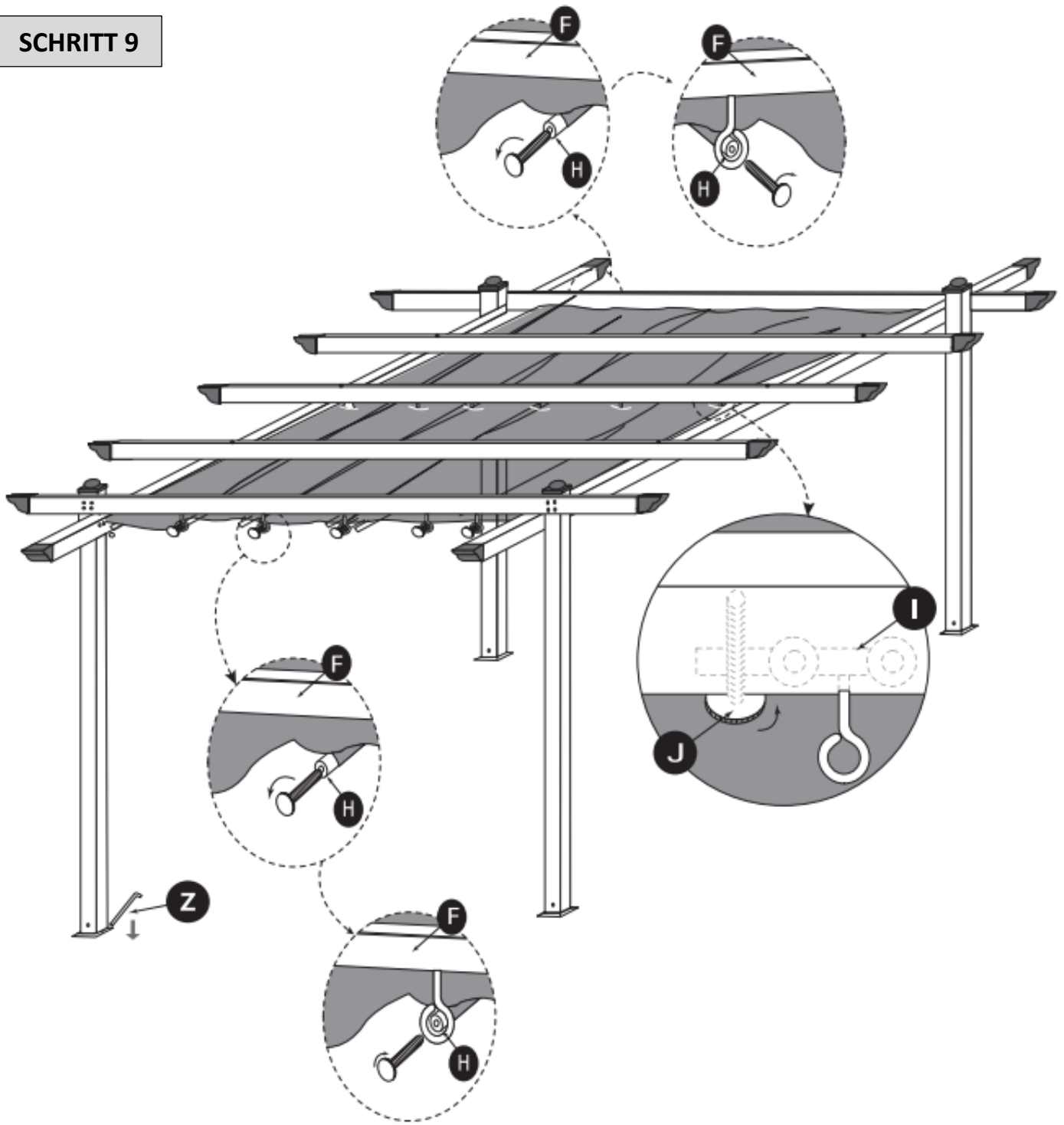



**Bitte unbedingt beachten:**

**Bevor Sie die Installation abschließen, müssen die Halteschlaufen des Dachs an den äußeren Laufrollen befestigt werden:**

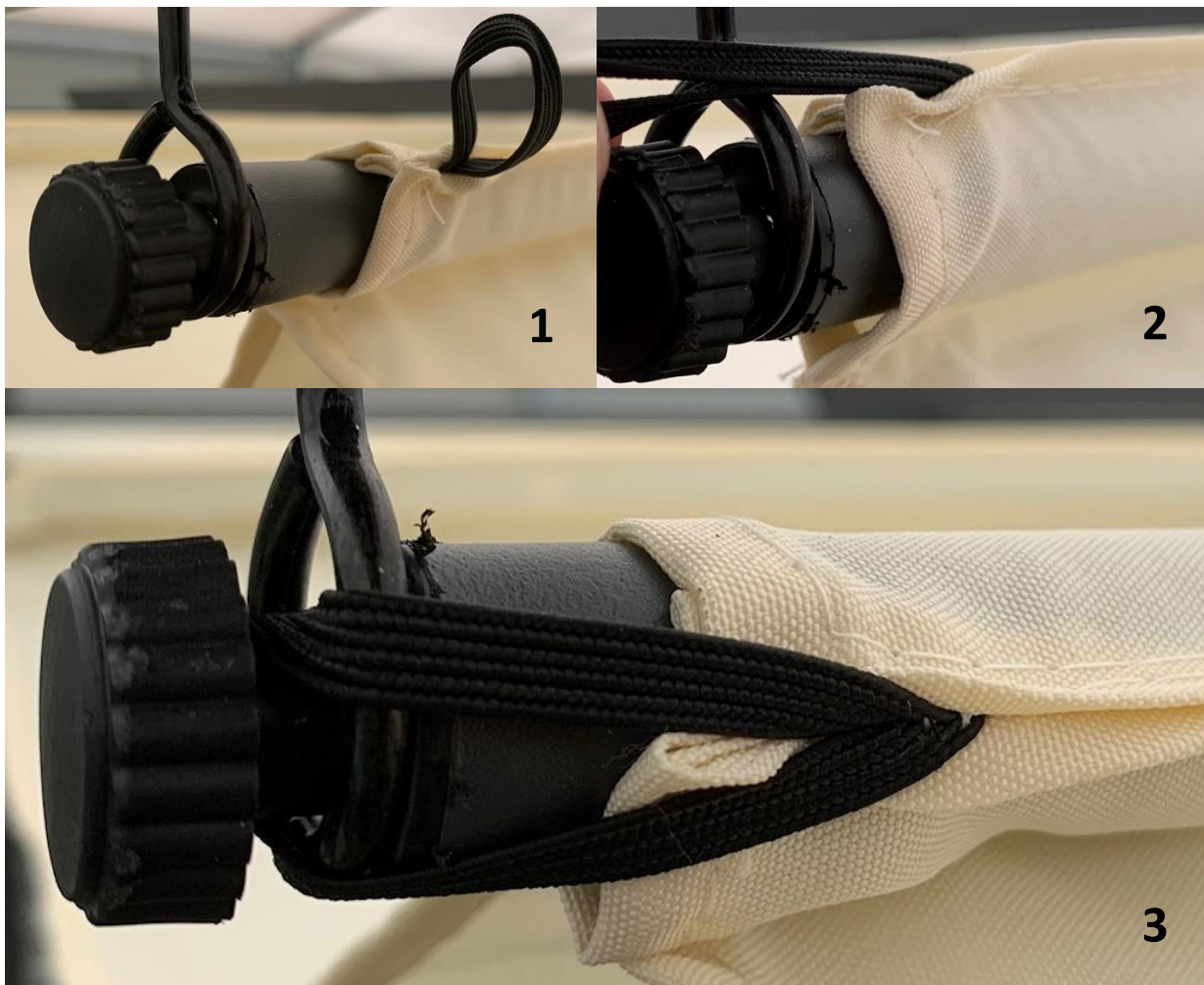

**Sofern Sie Ihren Pavillon nicht benutzen, empfehlen wir das Dach einzufahren. Bei starkem Wind/Sturm oder heftigem Regen muss das Pavillon-Dach abgenommen werden.**



**KBW Trading GmbH**  
Gewerbering 2  
88518 Herbertingen  
Deutschland  
Tel: 07586-921160  
Fax: 07586-9211616  
E-Mail: [info@jet-line.de](mailto:info@jet-line.de)  
[www.gartenmoebelkauf.de](http://www.gartenmoebelkauf.de)





## GAZEBO „LUXOR“

Article-No.: 2331 (anthracite) + 2826 (beige)

400 x 300 x 220 cm

- INSTRUCTION MANUAL -



**Installation-videos and instructions**

*for our products can be found on*

[www.gartenmoebelkauf.de](http://www.gartenmoebelkauf.de)









*Username: jet-line • Password: user2011*

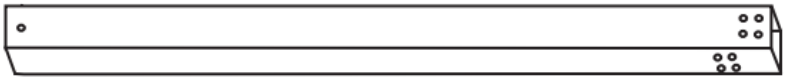
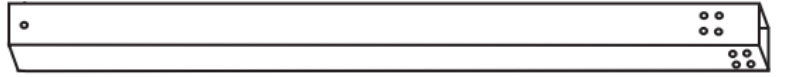
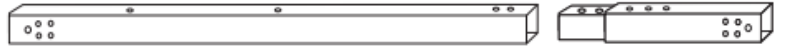
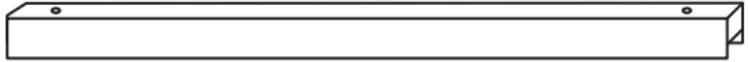
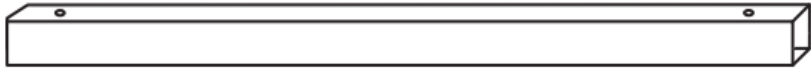

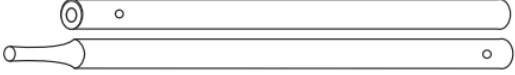

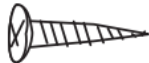



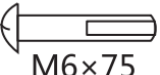

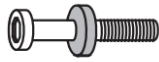
**More products for your garden**

*can be found on*

[www.gartenmoebelkauf.de](http://www.gartenmoebelkauf.de)

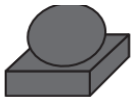
# Part-List

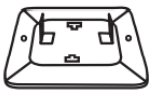
No.	Image	Description	Qty.
A		Standing Pole A 2826E018	2
B		Standing Pole B 2826E001	2
C		Top Beam 2826E013	1
D		Middle Rail 2826E002	1
D1		Top Beam 2826E012	2
E		Top Beam 2836E003	1
F		Top Beam F 2826E009	2
G		Outer Stabilisation Rod for fabric-roof 2826E004	1
H		Stabilisation Rod for fabric-roof 2826E005	5
I + J		Roll I (+ Screw J) 2331E000	1
K		Screw	4
L		Roll L 2331E001	4
M		Roll M 2331E015	10
N		Roll N 2331E003	1
O	 M6x75	Screw M6x75	6

P	 M6x45	Special Screw P M6x45 2826E006	32
R	 M6x12	Screw M6x12	8
S		Allen Key	1
T		Screwdriver	1
U		Roof-Fabric U 2826E000 / 2331E004	1
V		End cap (side) 2827E001	14
W		End cap (top) 2826E016	4
X	 M6x30	Screw M6x30	2
Y		Base Plate	4
Z		Ground Anchor	8

# Assembly Instruction

STEP 1

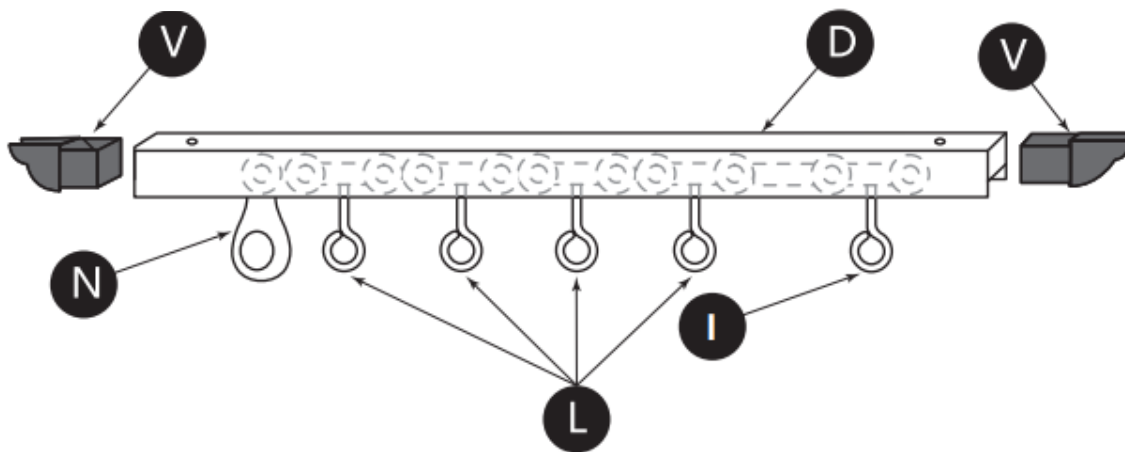

STEP 2

x 2

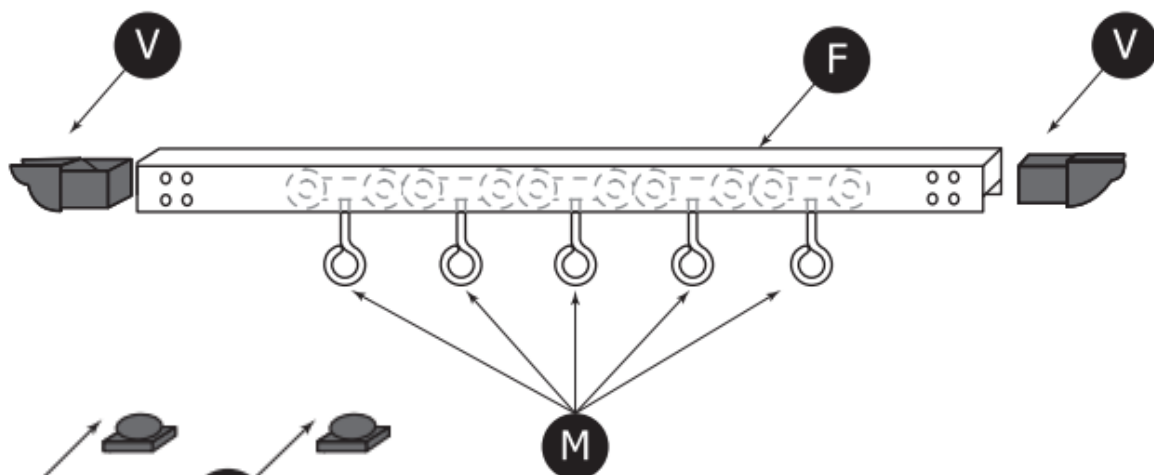

STEP 3

x 2

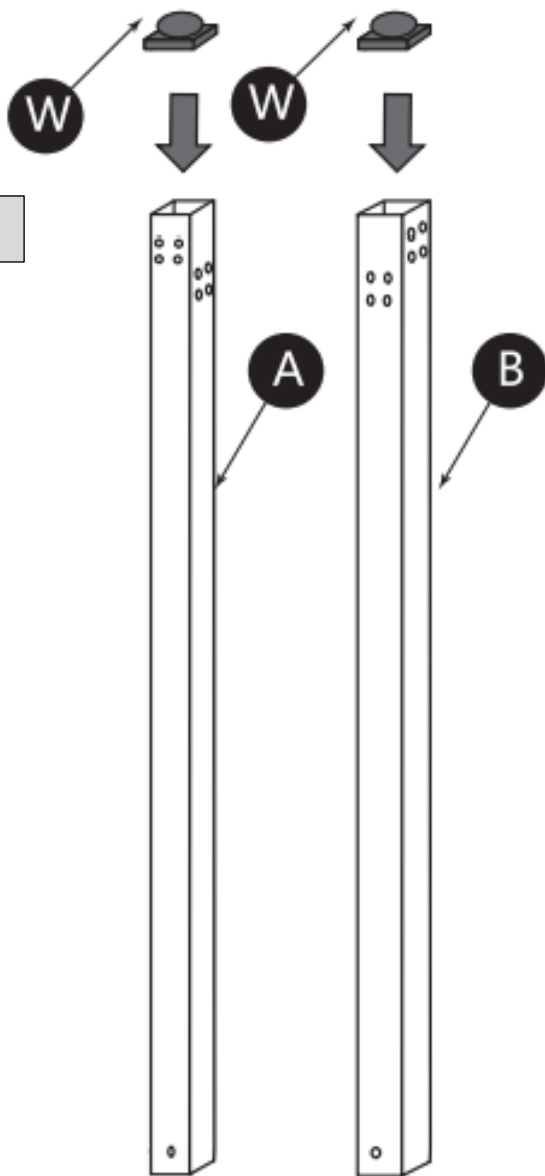

STEP 4

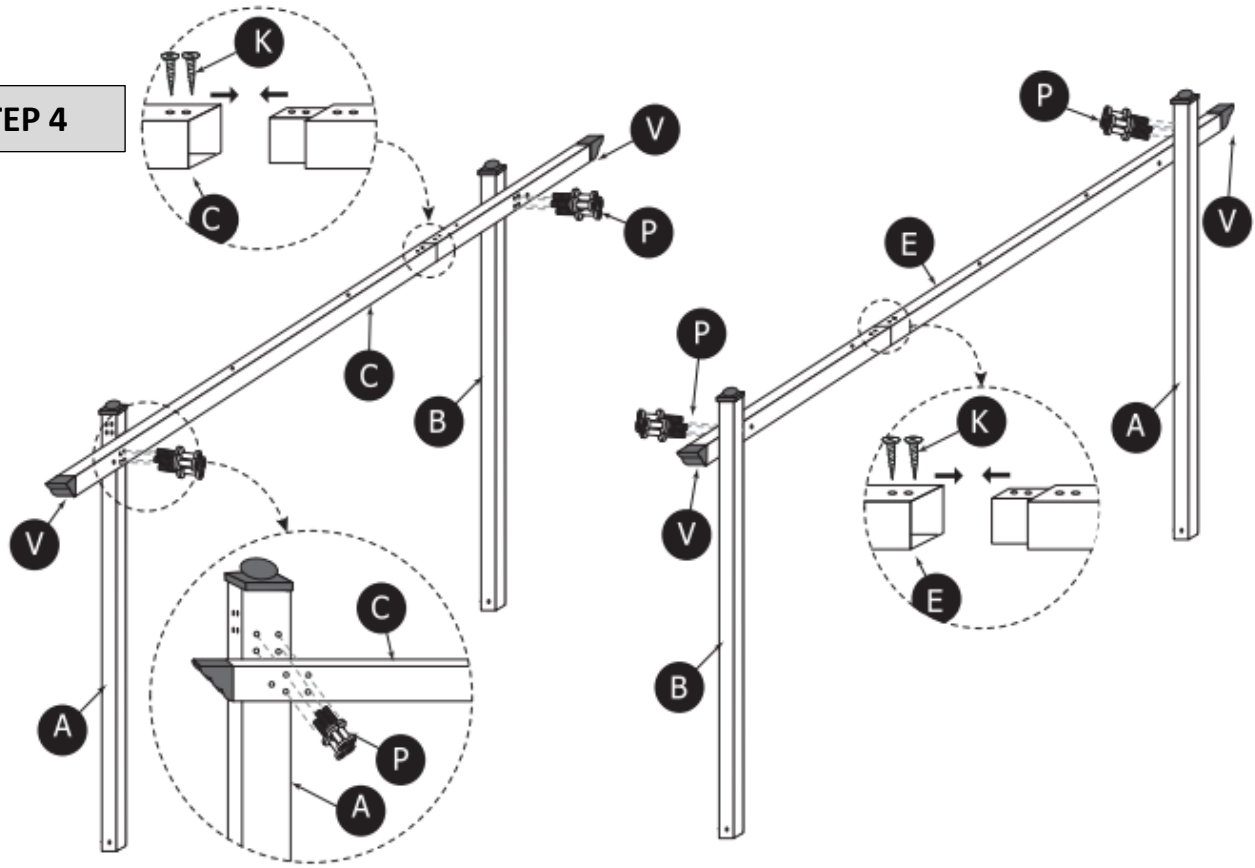

STEP 5

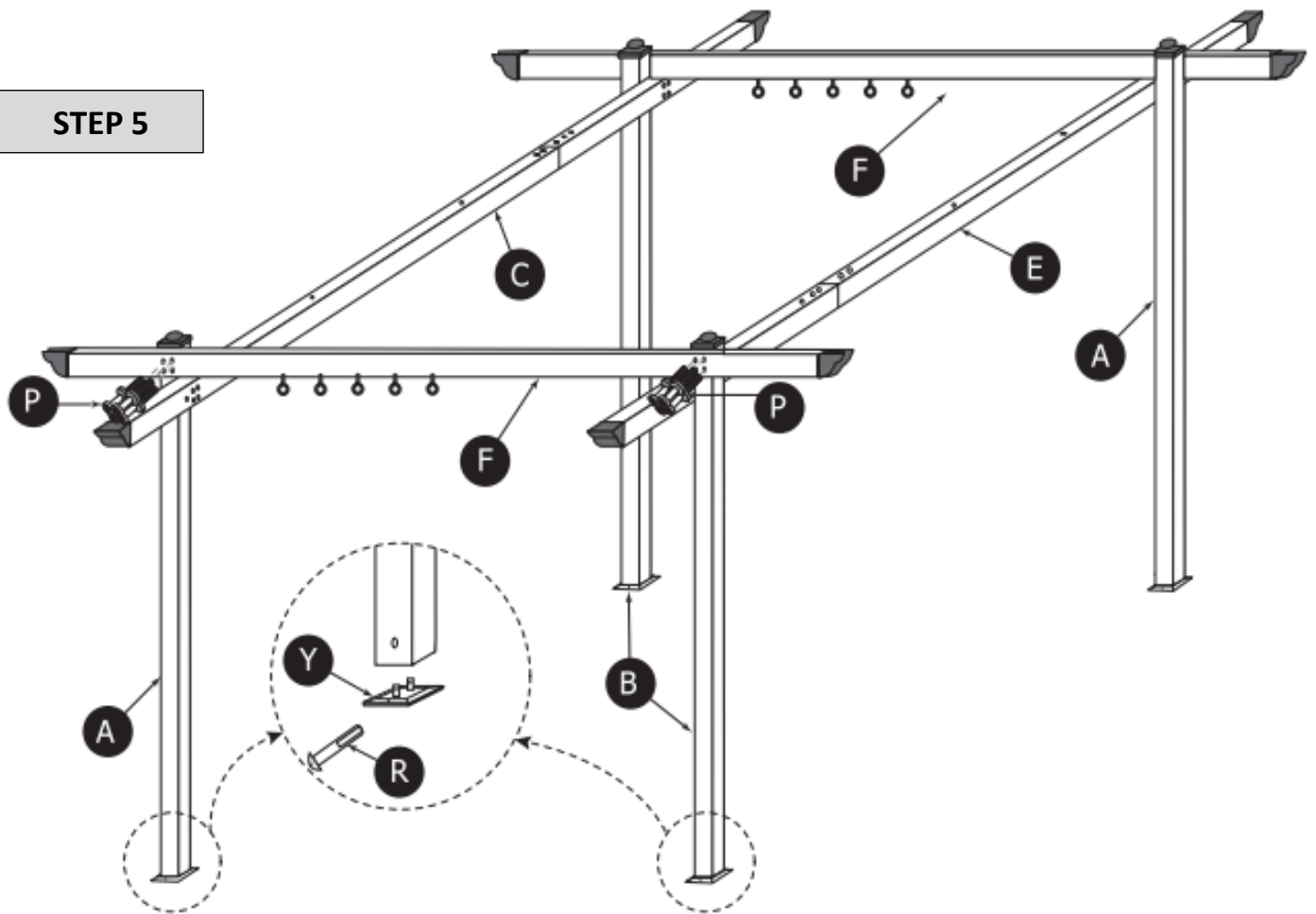

STEP 6

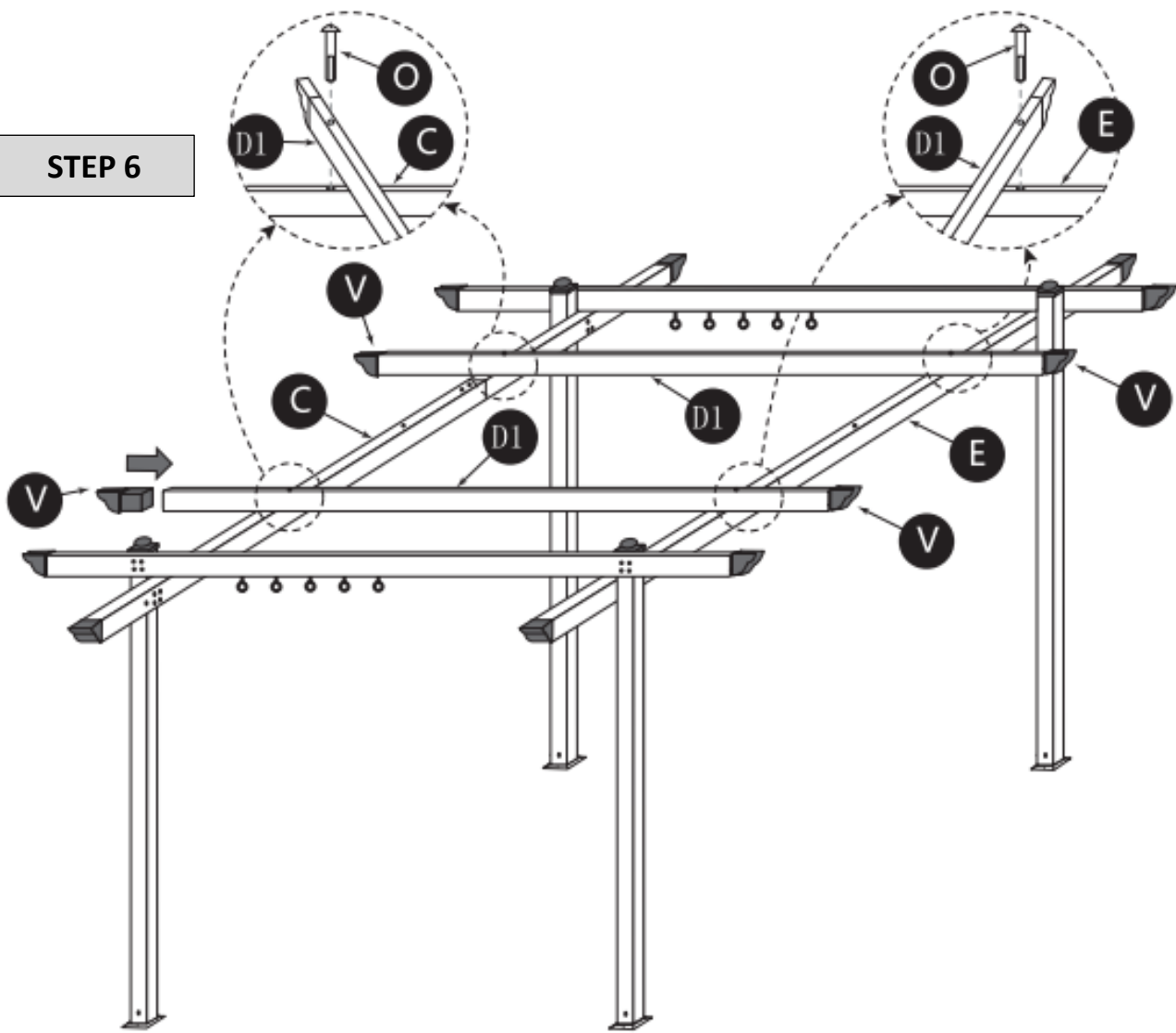

STEP 7

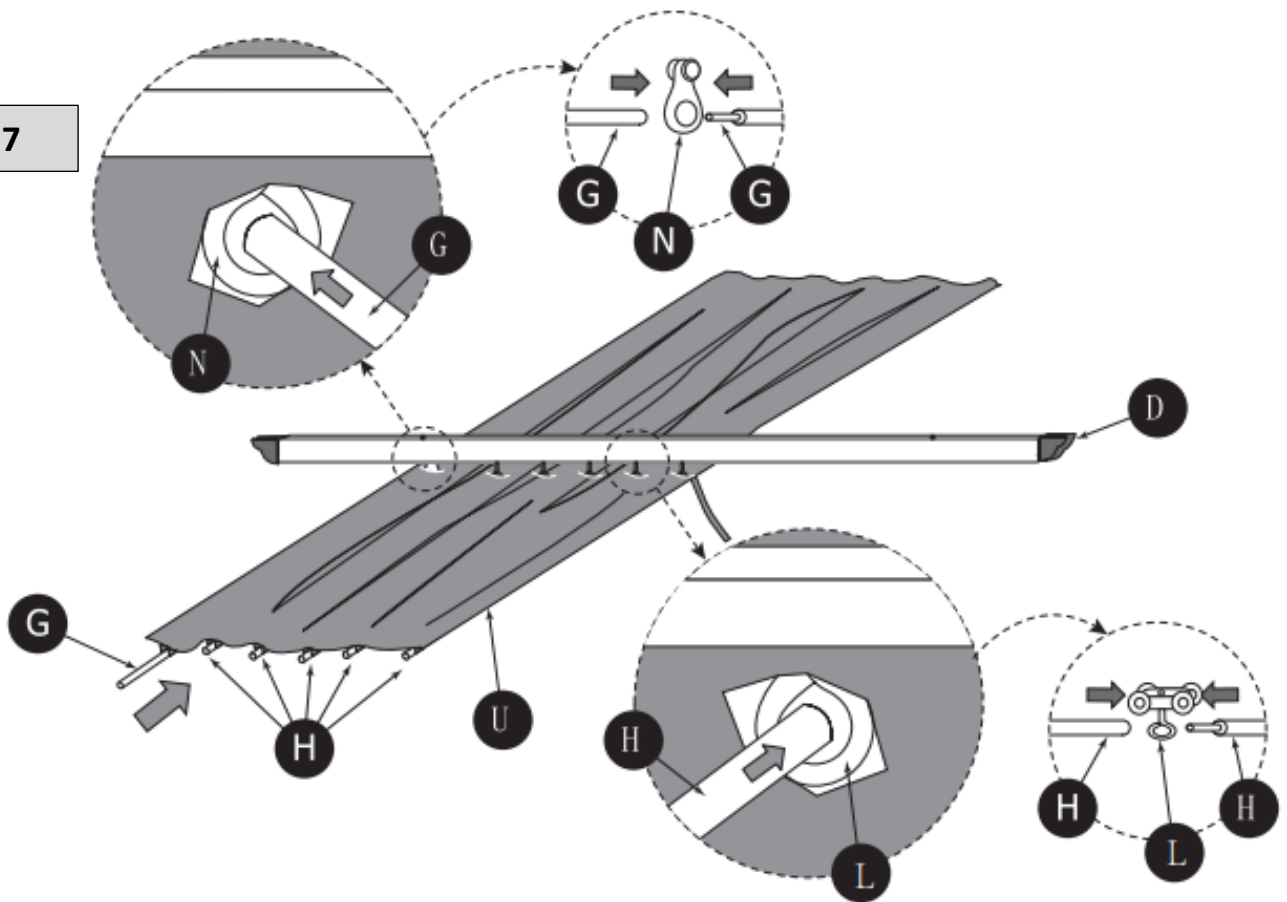



STEP 8

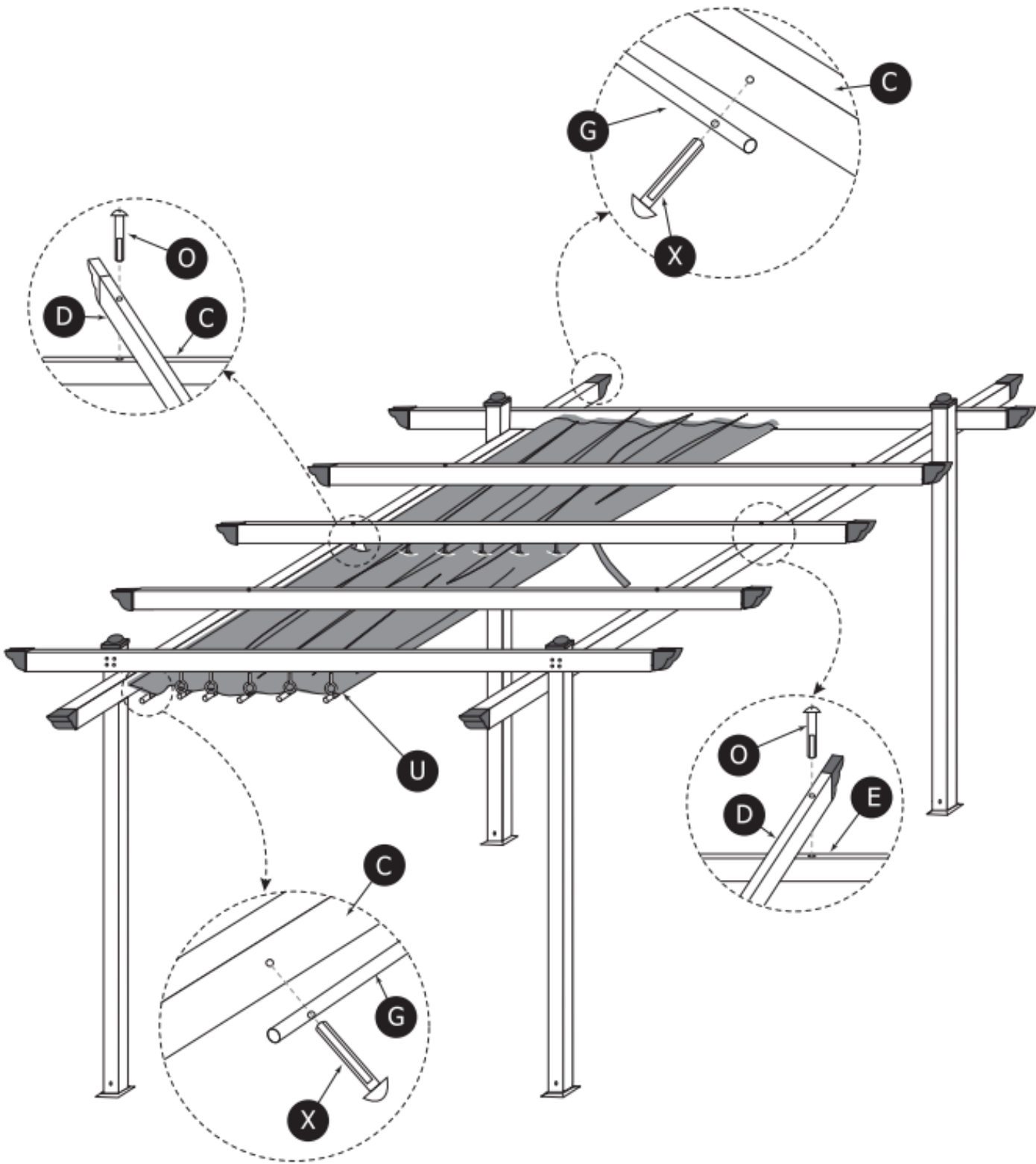

STEP 9

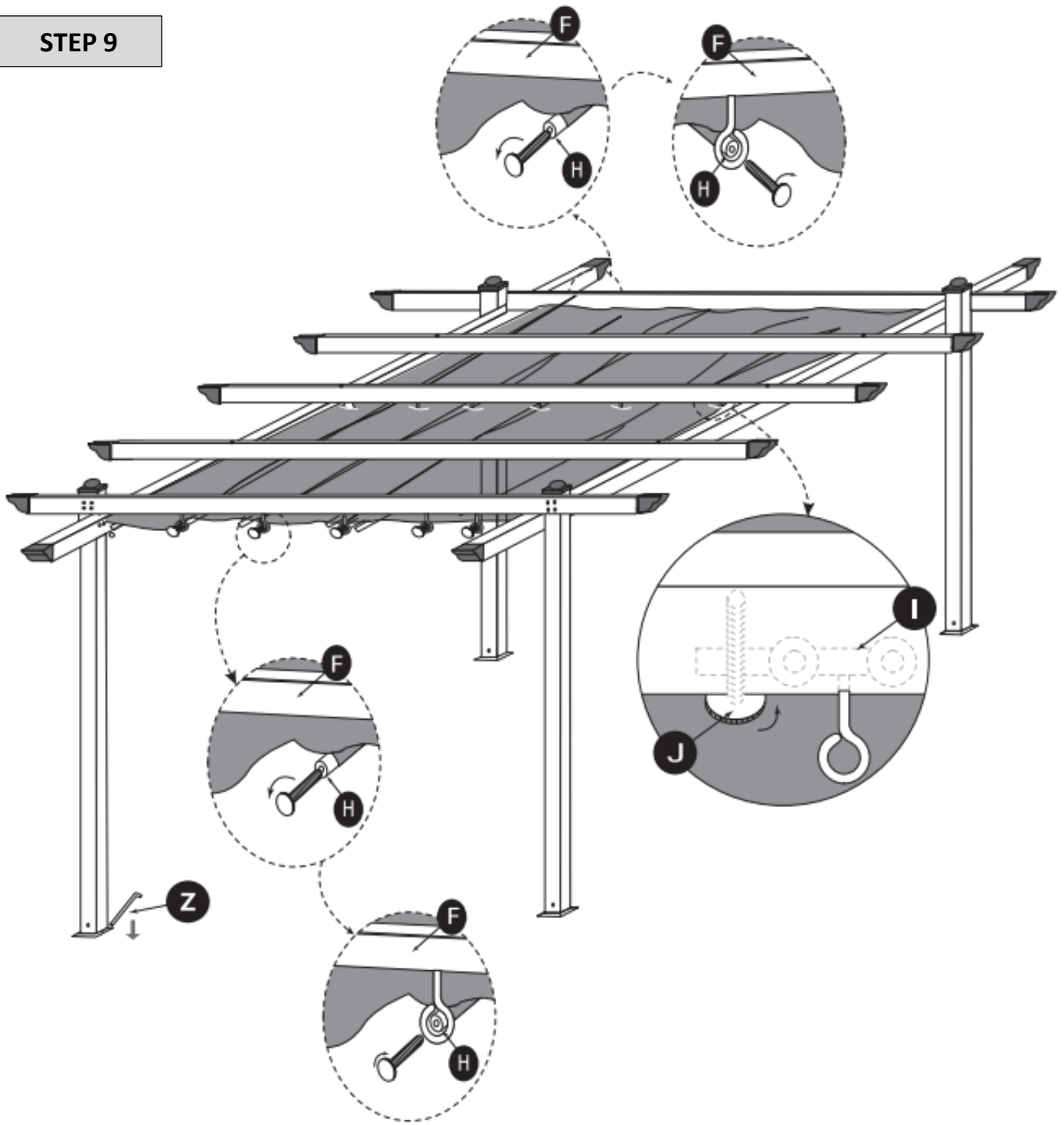

**NOTE:**

**Before you finish installation, please fix the fabric-straps on the outer castor as shown in the pictures below:**

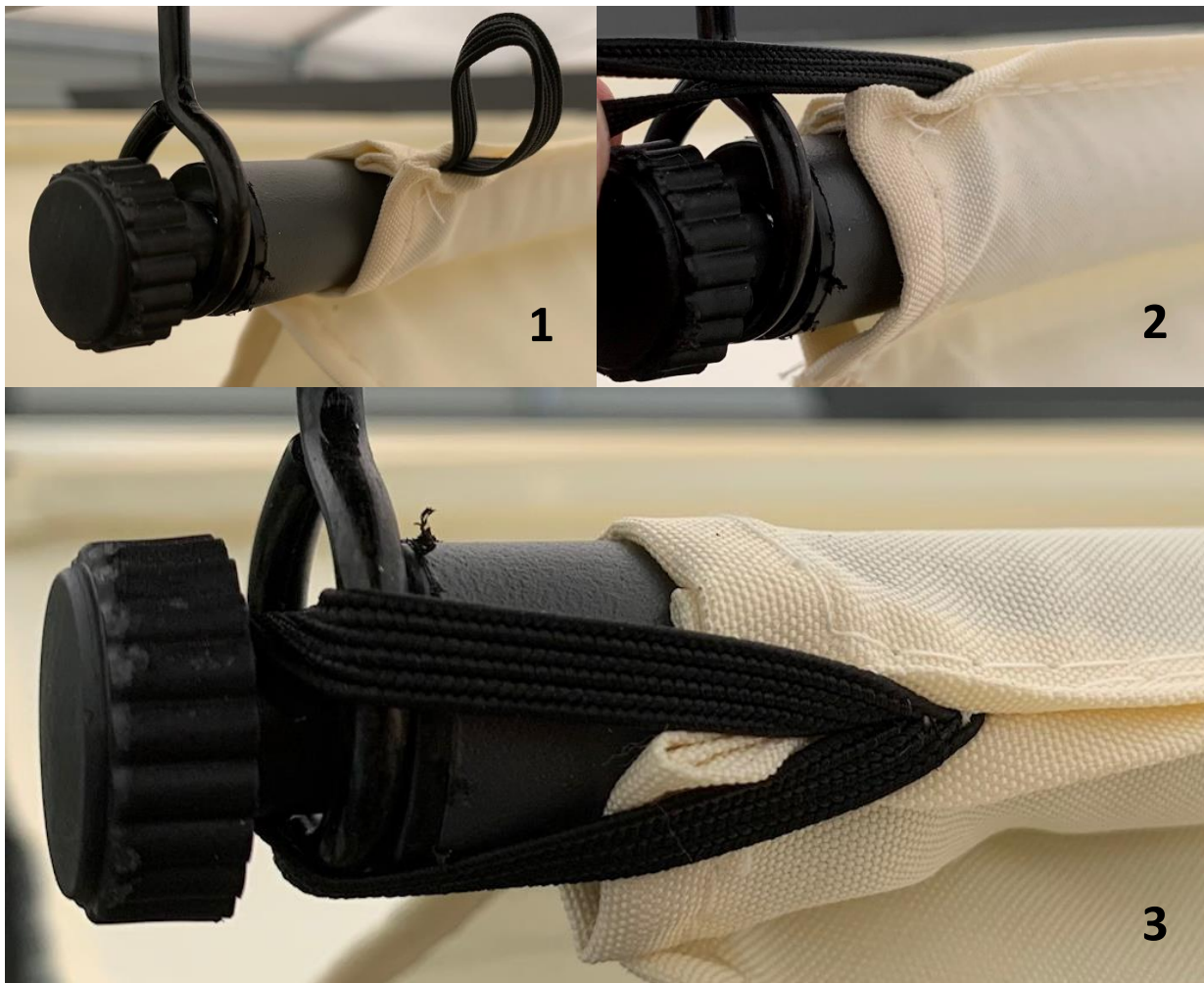

**While your pavilion is not in use, we suggest pulling back the roof. Please make sure to remove the roof-fabric in weather-conditions with strong wind/storm or heavy rain.**



KBW Trading GmbH  
Gewerbering 2  
88518 Herbertingen  
Germany  
Phone: 07586-921160  
Fax: 07586-9211616  
E-Mail: [info@jet-line.de](mailto:info@jet-line.de)  
[www.gartenmoebelkauf.de](http://www.gartenmoebelkauf.de)

