

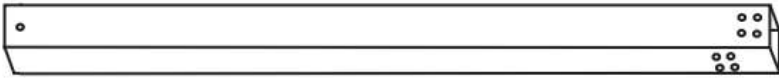

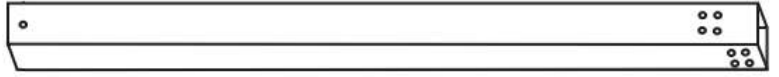







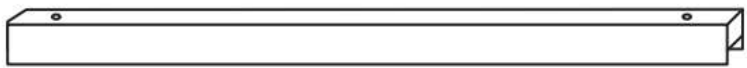

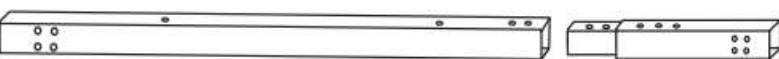

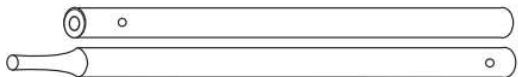

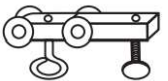
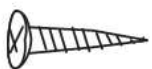

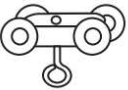
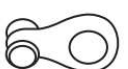
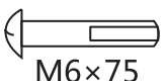
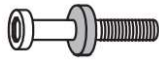

Teile-Liste

Nr.	Abb.	Bezeichnung	Stz.
A		Standsäule A 2826E018	2
B		Standsäule B 2826E001	2
C		Oberer Rahmenverbinder 2826E013	1
D		Mittlere Laufschiene 2826E002	1
D1		Querverbinder 2826E012	2
E		Oberer Rahmenverbinder 2836E003	1
F		Oberer Rahmenverbinder F 2826E009	2
G		Äußere Stabi- Stange Stoffdach 2826E004	1
H		Stabi-Stange Stoffdach 2826E005	5
I + J		Rolle I (+ Schraube J) 2331E000	1
K		Schraube	4
L		Rolle L 2331E001	4
M		Rolle M 2331E015	10
N		Rolle N 2331E003	1
O	 M6x75	Schraube M6x75	6

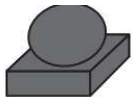
P	 M6x45	Spezierschraube P M6x45 2826E006	32
R	 M6x12	Schraube M6x12	8
S		Inbusschlüssel	1
T		Schraubenzieher	1
U		Stoffdach U 2826E000 / 2331E004	1
V		Endstück 2827E001	14
W		Obere Abdeckung 2826E016	4
X	 M6x30	Schraube M6x30	2
Y		Bodenplatte	4
Z		Bodenanker	8

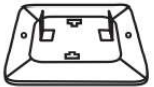
Aufbauanleitung

SCHRITT 1

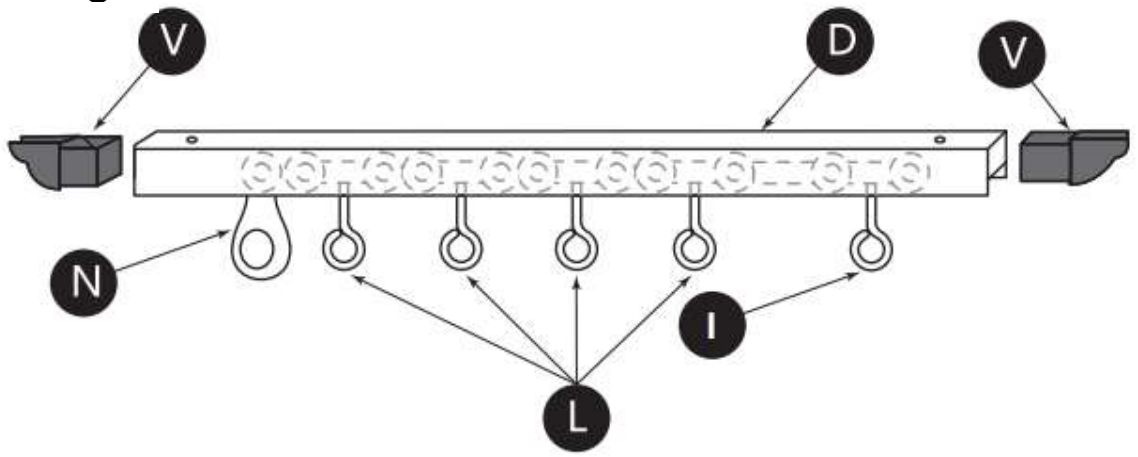

SCHRITT 2

x 2

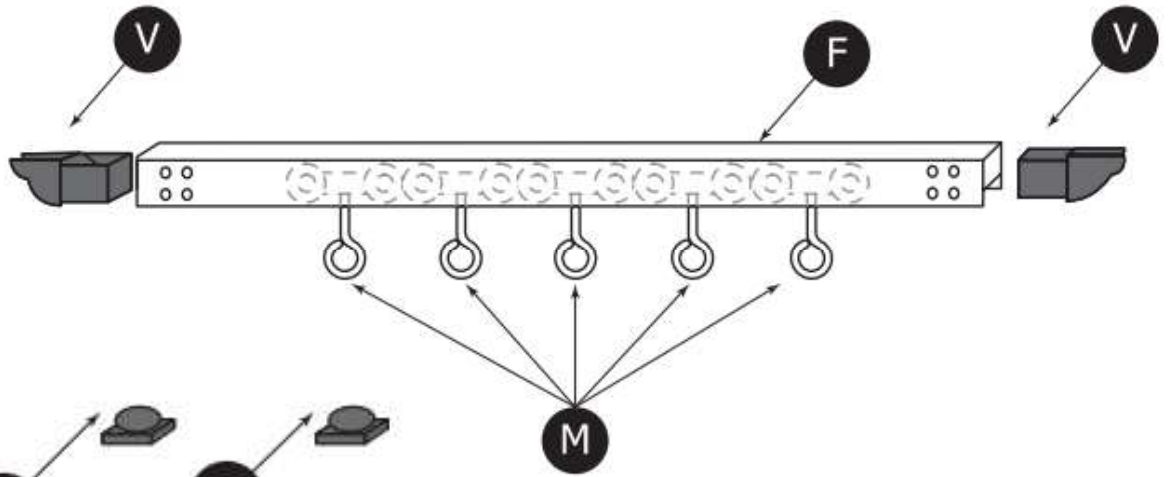

SCHRITT 3

x 2

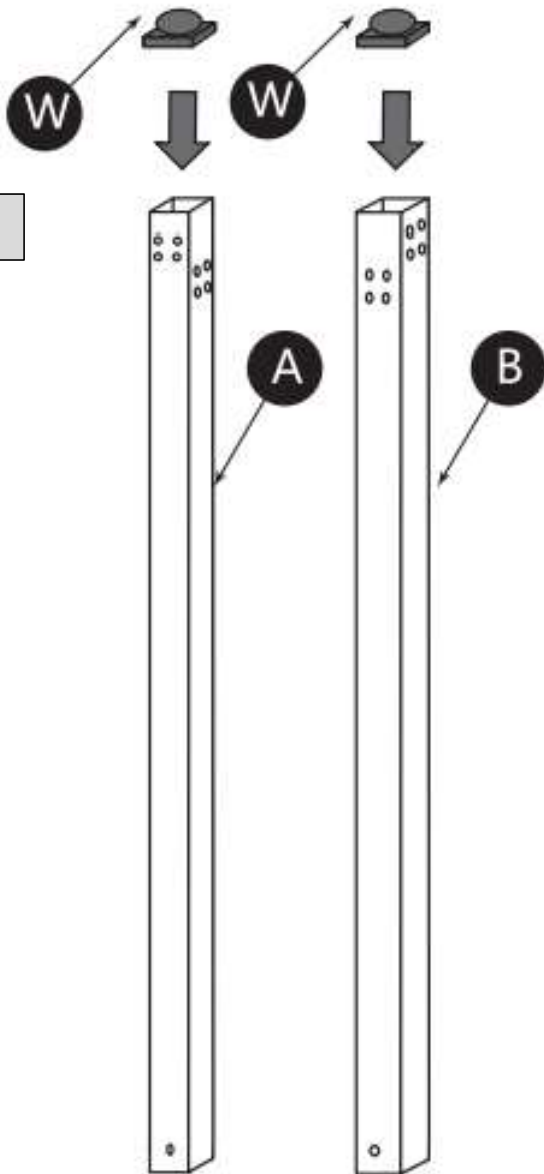

SCHRITT 4

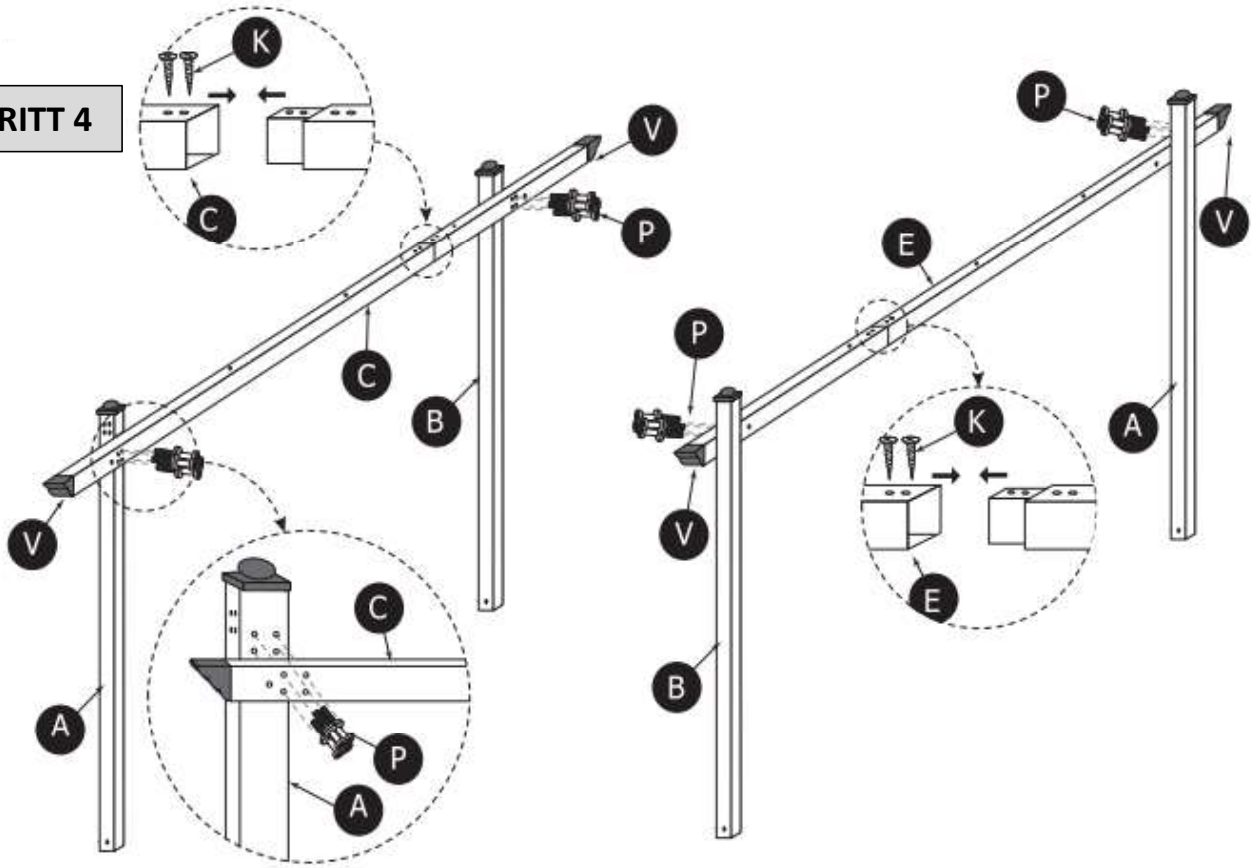

SCHRITT 5

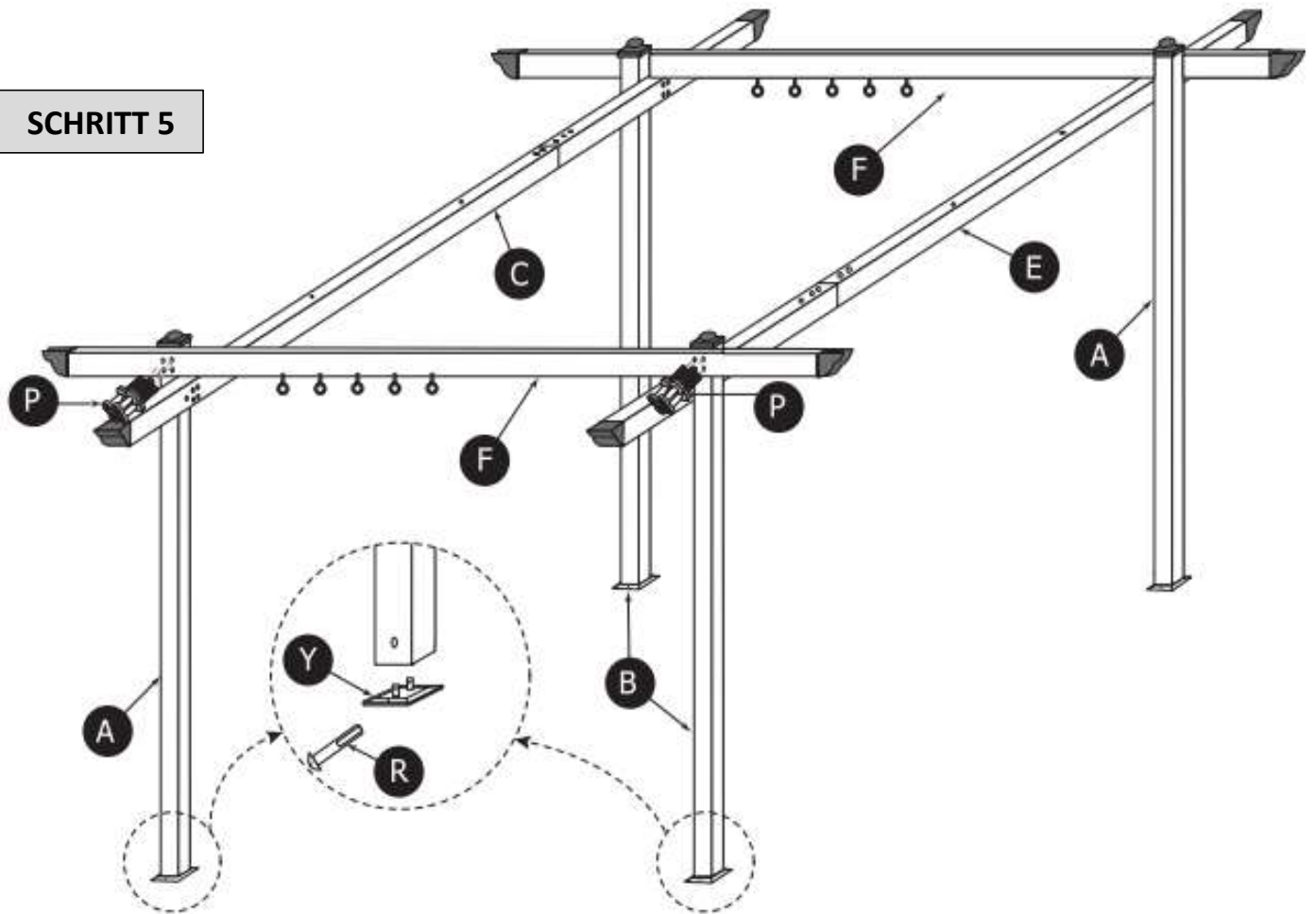

SCHRITT 6

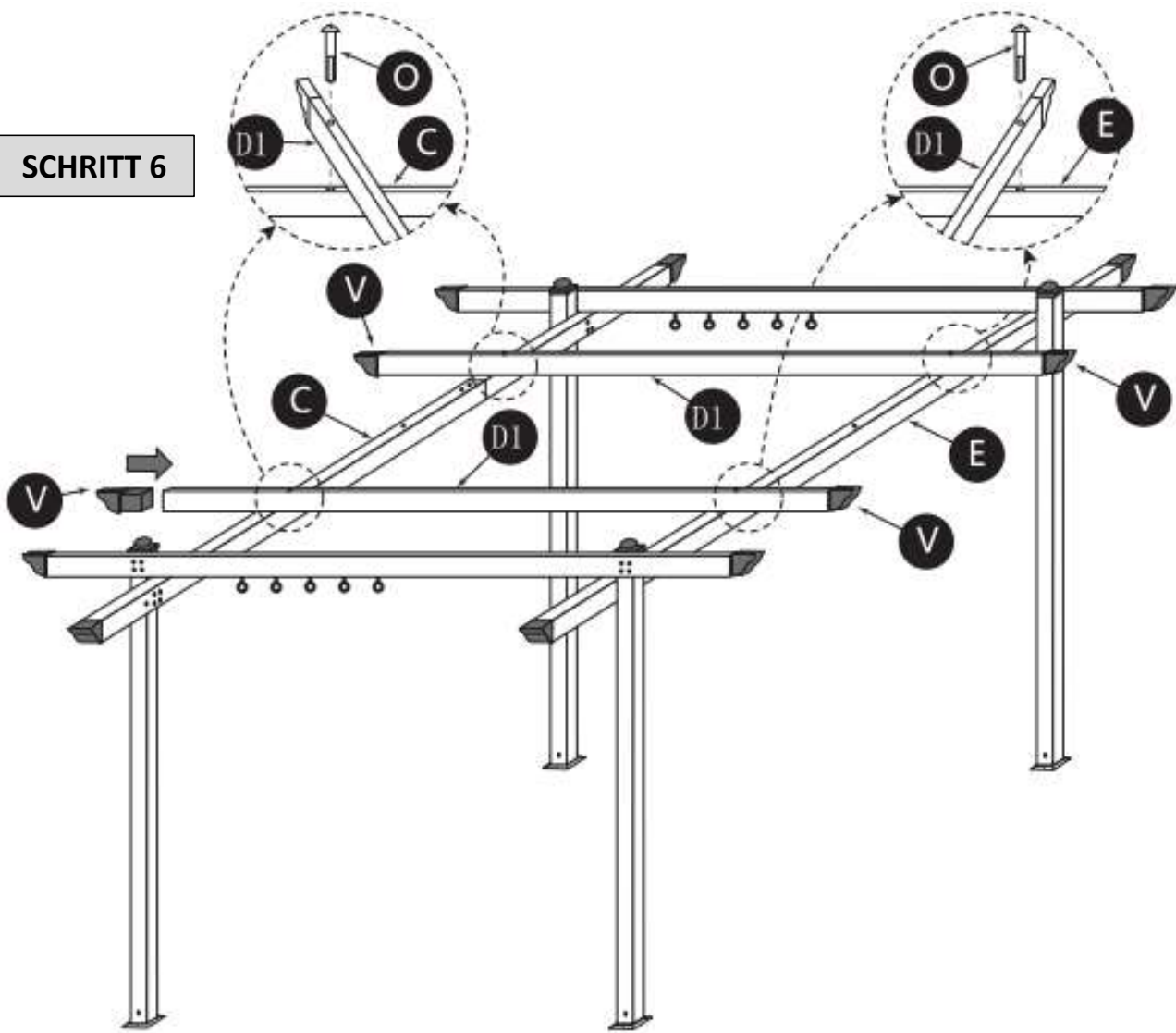

SCHRITT 7

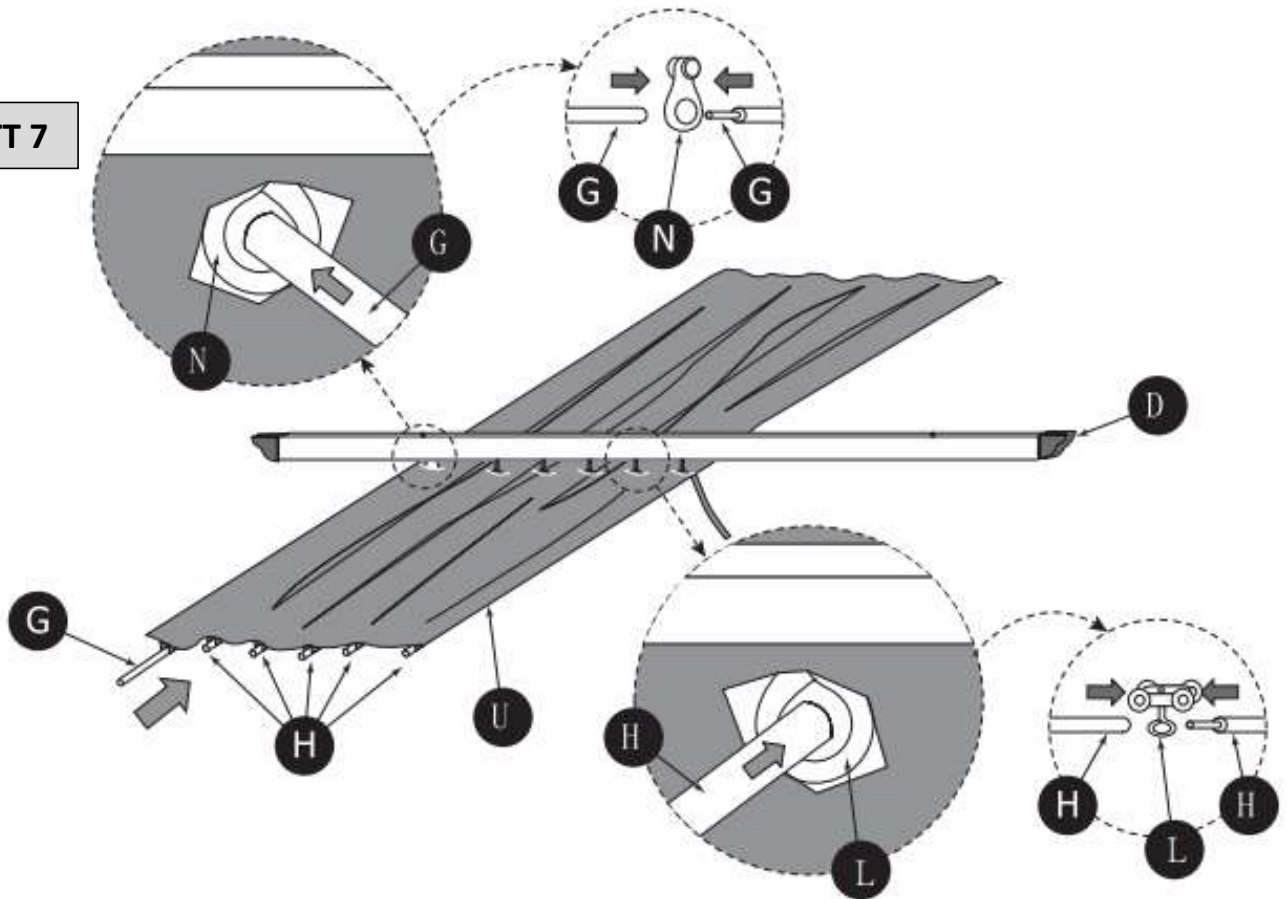

SCHRITT 8

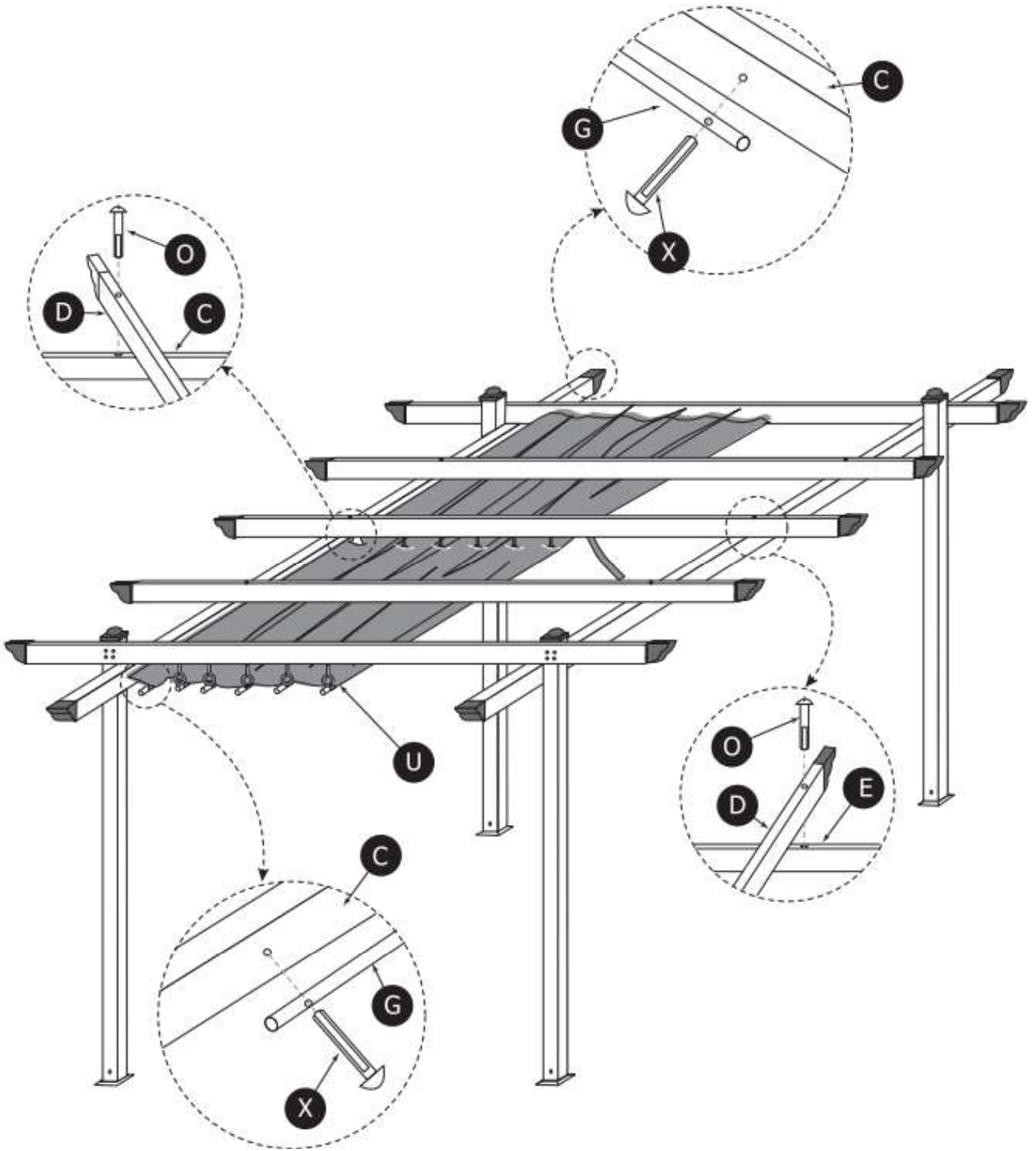

SCHRITT 9

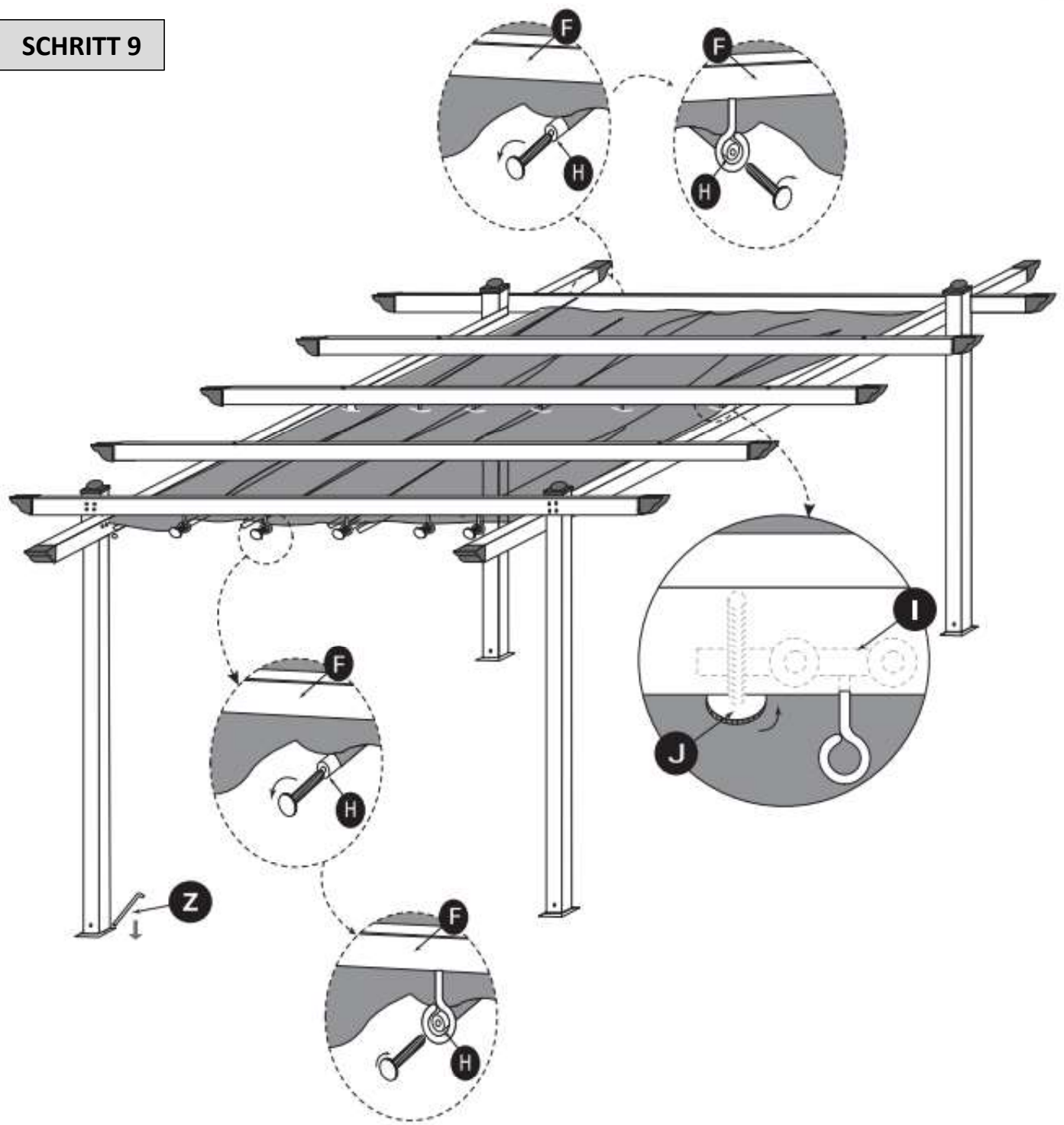

Bitte unbedingt beachten:

Bevor Sie die Installation abschließen, müssen die Halteschlaufen des Dachs an den äußeren Laufrollen befestigt werden:

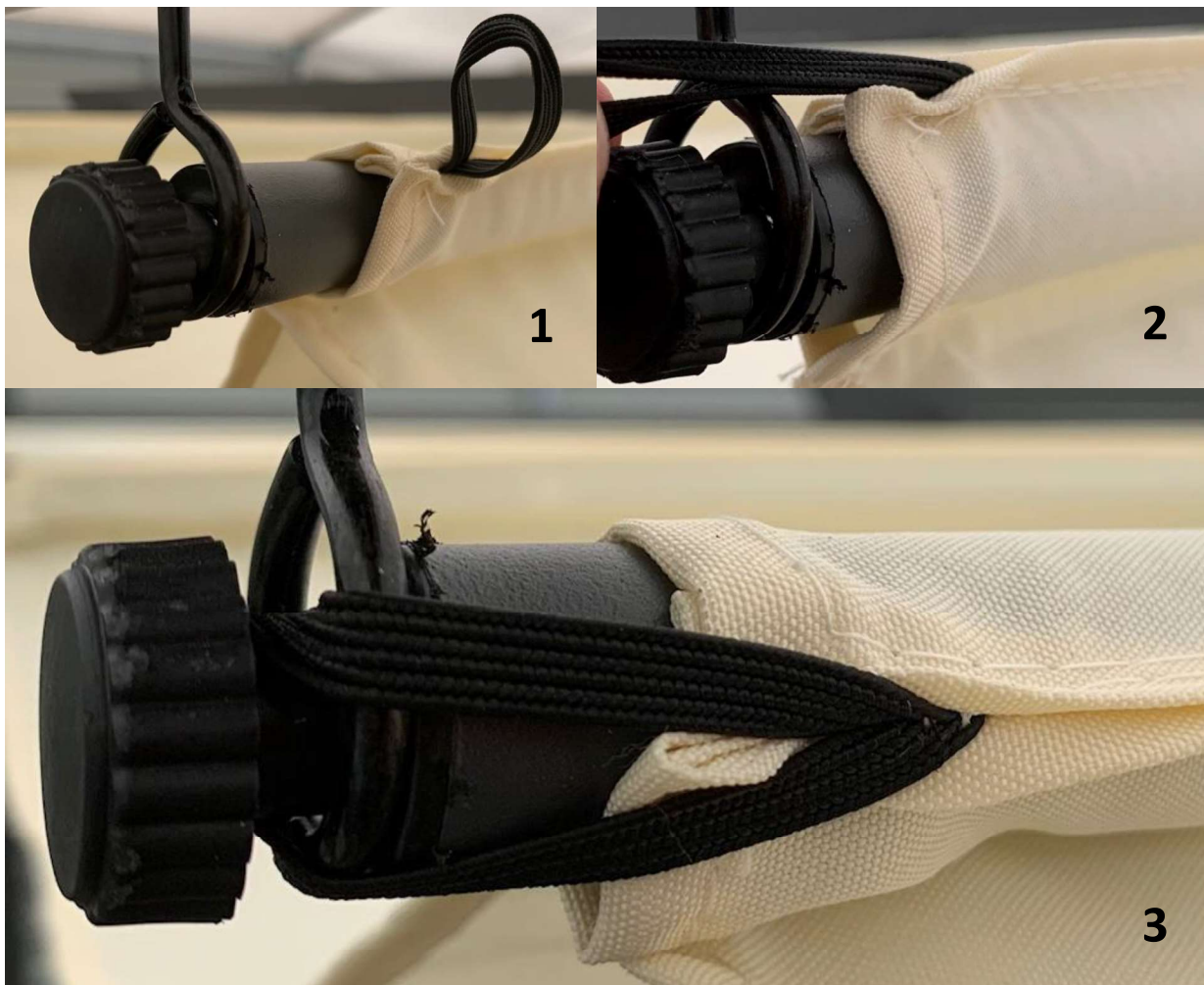

Sofern Sie Ihren Pavillon nicht benutzen, empfehlen wir das Dach einzufahren. Bei starkem Wind/Sturm oder heftigem Regen muss das Pavillon-Dach abgenommen werden.