



GARTENPAVILLON „SUEZ“

Artikel-Nr.: 23015

300 x 300 x 264 cm

- AUFBAUANLEITUNG -

























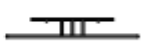

Installationsvideos und Aufbauanleitungen

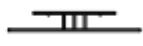











*zu unseren Produkten finden Sie
in unserem Shop beim jeweiligen Produkt*



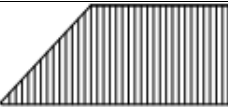
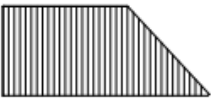

Weitere Produkte für Haus und Garten

*finden Sie unter
www.jet-line.de*

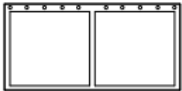
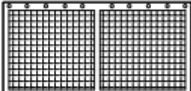
Teile-Liste

Nr.	Abb.	Bezeichnung	Stz.
A			4
B			4
B1			4
C			4
D			4
E			4
E1			4
F			4
F1			4
G			4
G1			4
H			1
I			1
J			4
K			4

Nr.	Abb.	Bezeichnung	Stz.
K1			4
L			4
M			4
N			4
O			4
P			4
Q			4
R			8
S			4
S1			4
T			3
T1			2
V			80
W			4
X			4

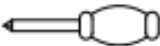
Nr.	Abb.	Bezeichnung	Stz.
AA		Schraube M6*20	66
BB		Schraube M6*15	96
CC		Schraube M5*15	24
DD		Schraube M5*15	4
EE	 4mm	Inbusschlüssel 4 mm	2
FF		Schraubenzieher	1

Aufbauanleitung

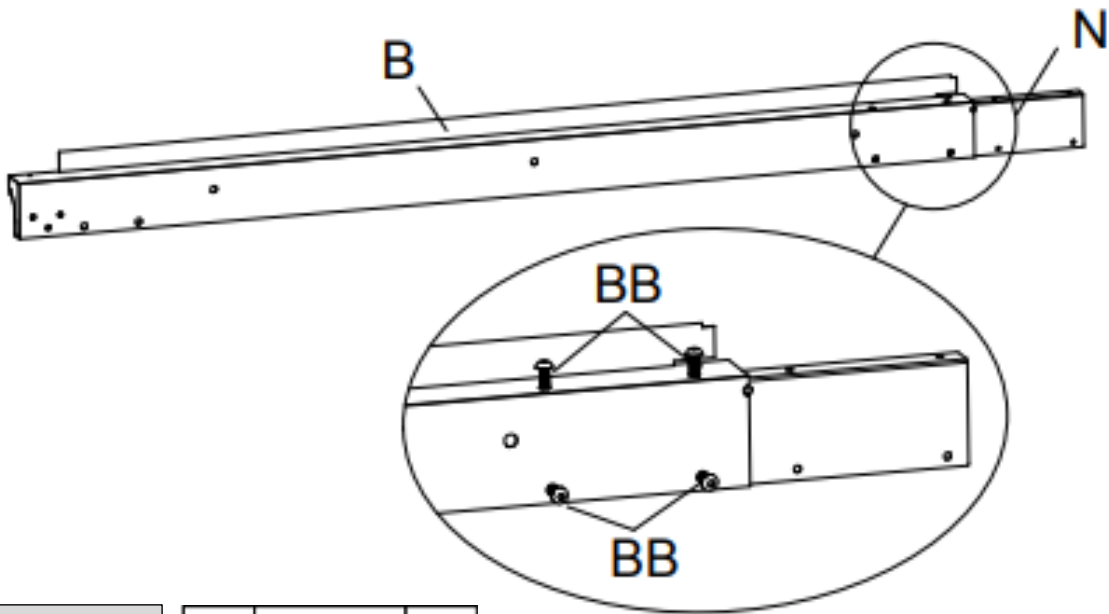

SCHRITT 1

BB		M6*15	16
----	---	-------	----



X4

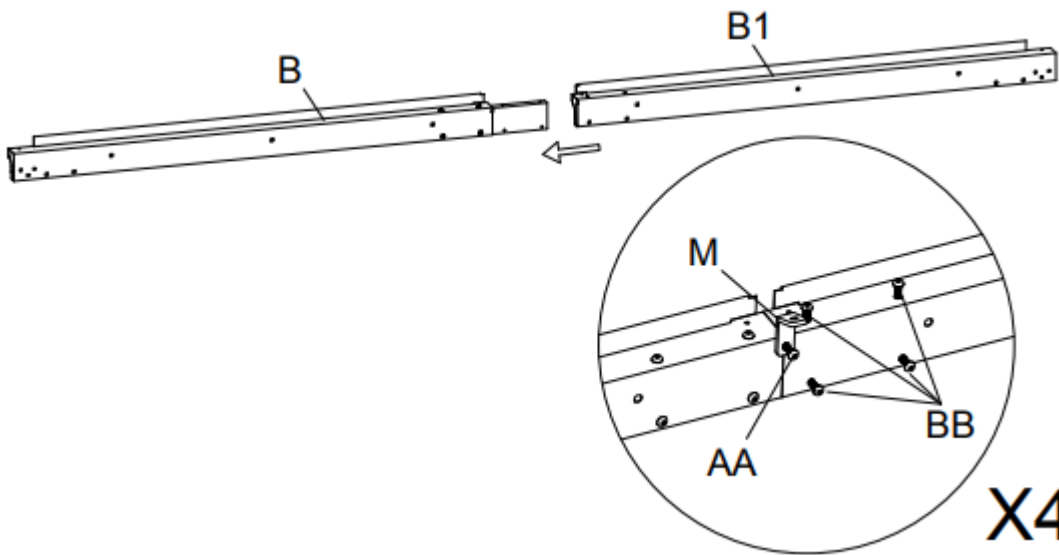

SCHRITT 2

AA		M6*20	4
BB		M6*15	16
M			4



X4

SCHRITT 3

CC	 M5*15	8
DD	 M5*15	4
O		4

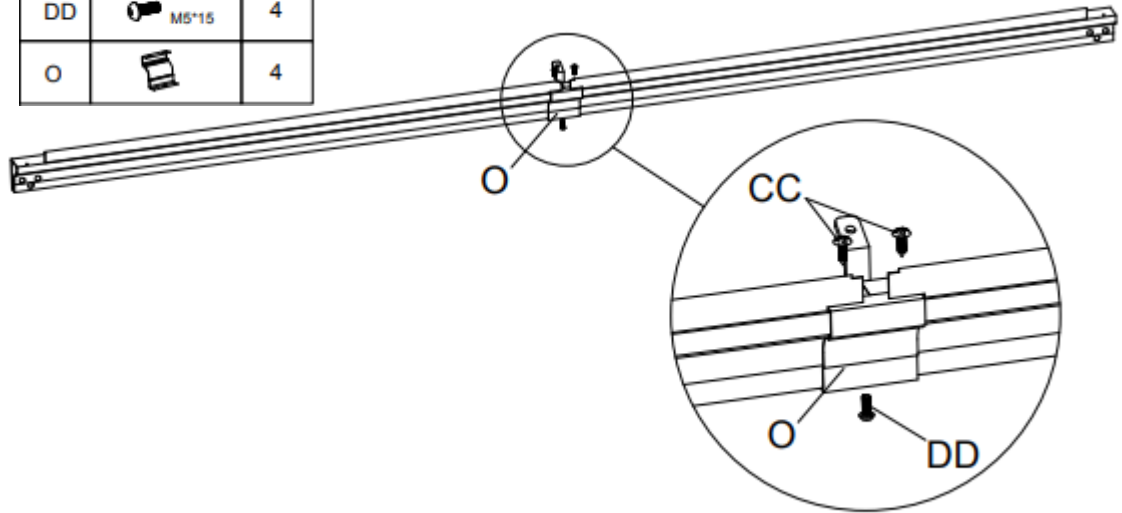

X4

SCHRITT 4

V		80
---	---	----

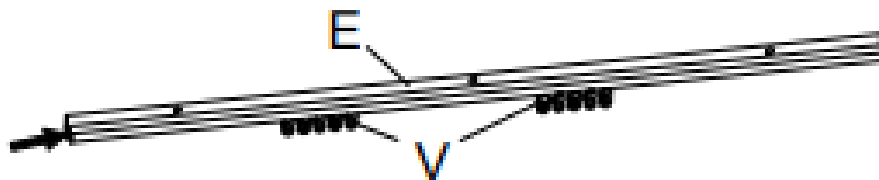
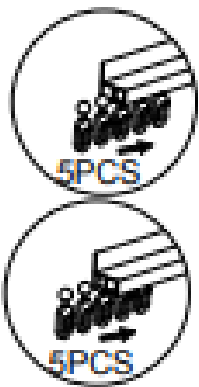

X4

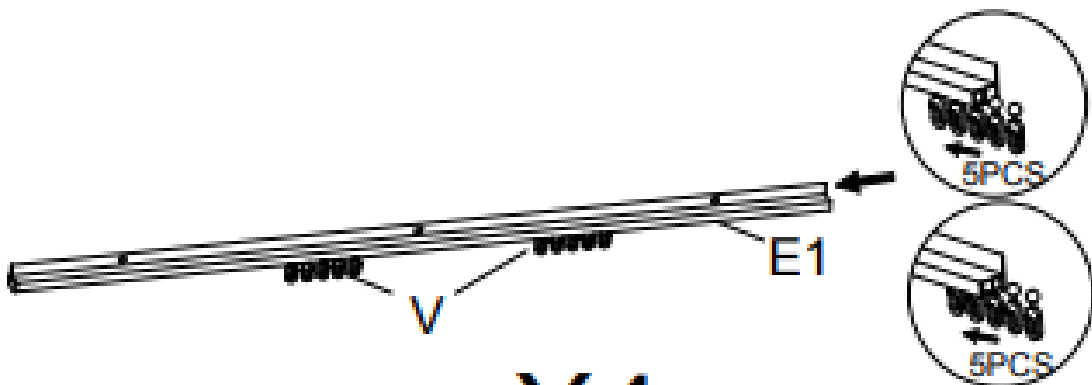



X4

SCHRITT 5

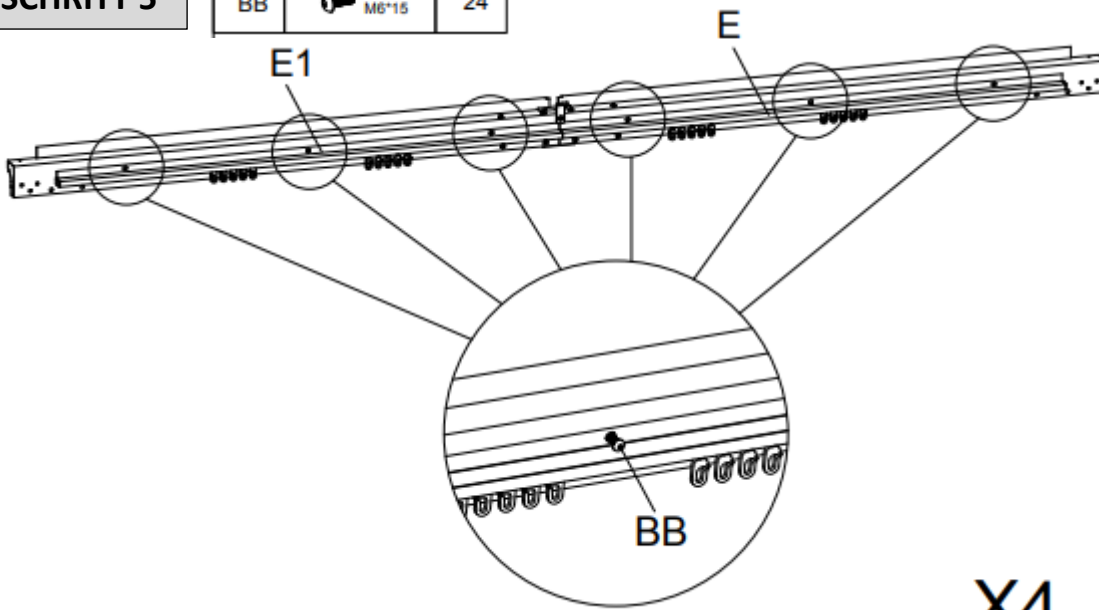
BB	 M6*15	24
----	---	----



SCHRITT 6

AA	 M6*20	20
L		4
J		4

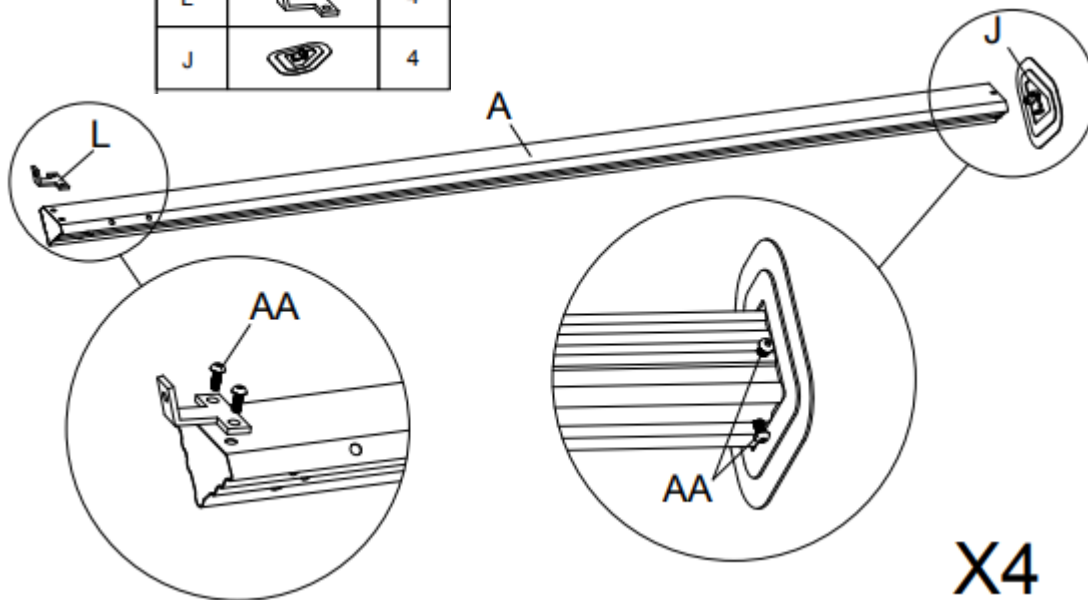

SCHRITT 7

AA



12

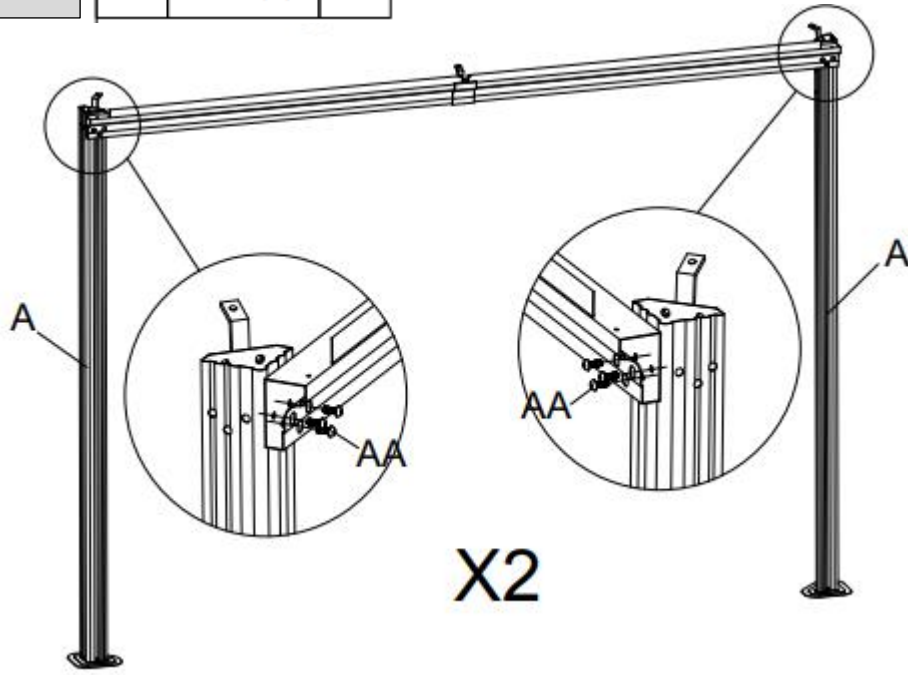

SCHRITT 8

BB



16

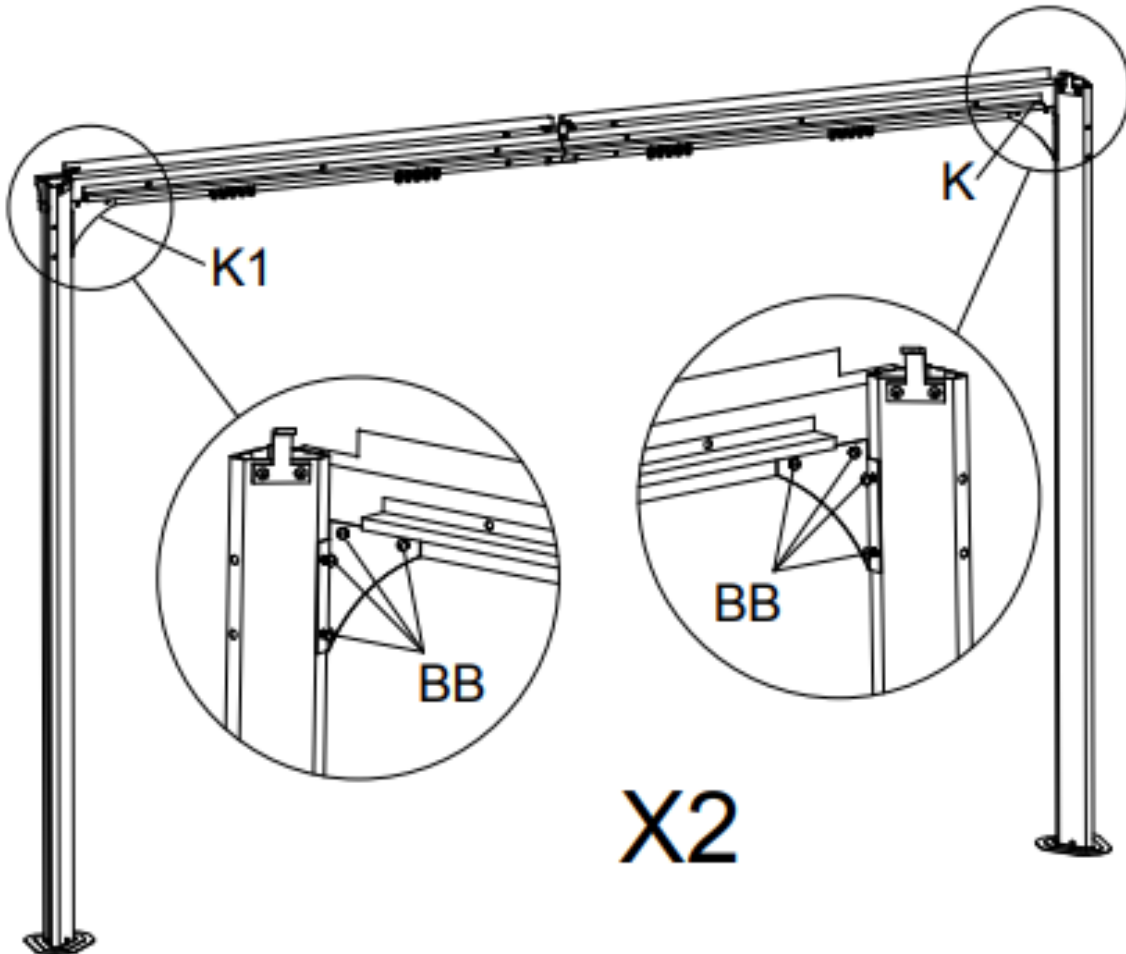

SCHRITT 9

AA

M6*20

12

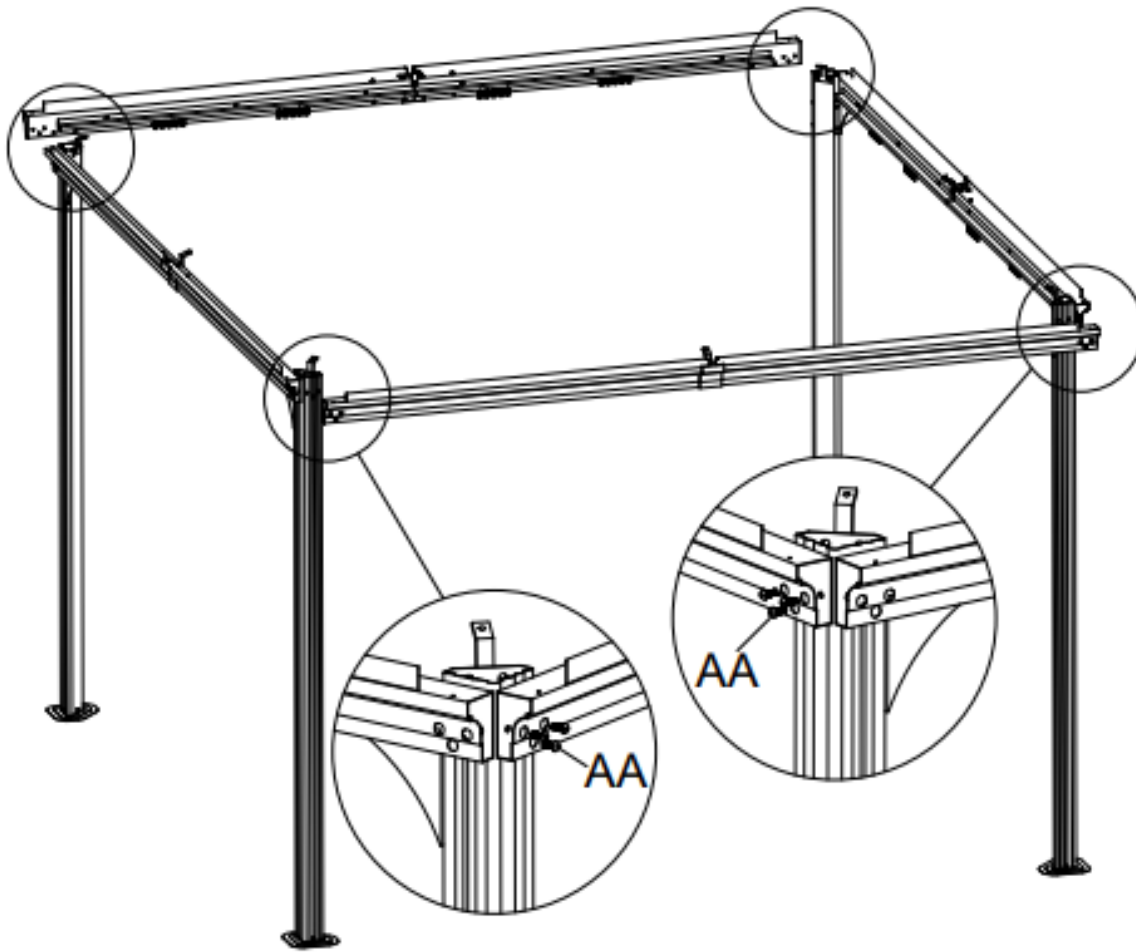

SCHRITT 10



BB

M6*15

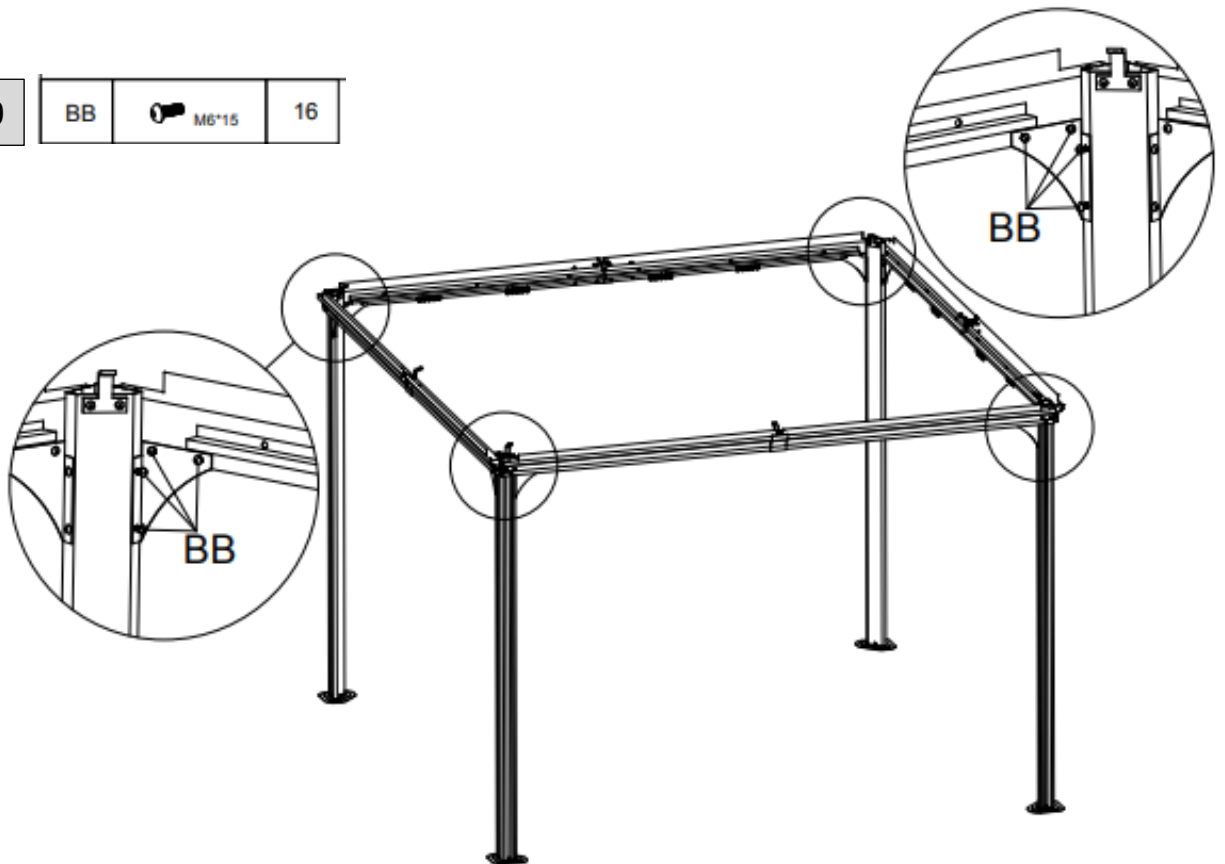
16



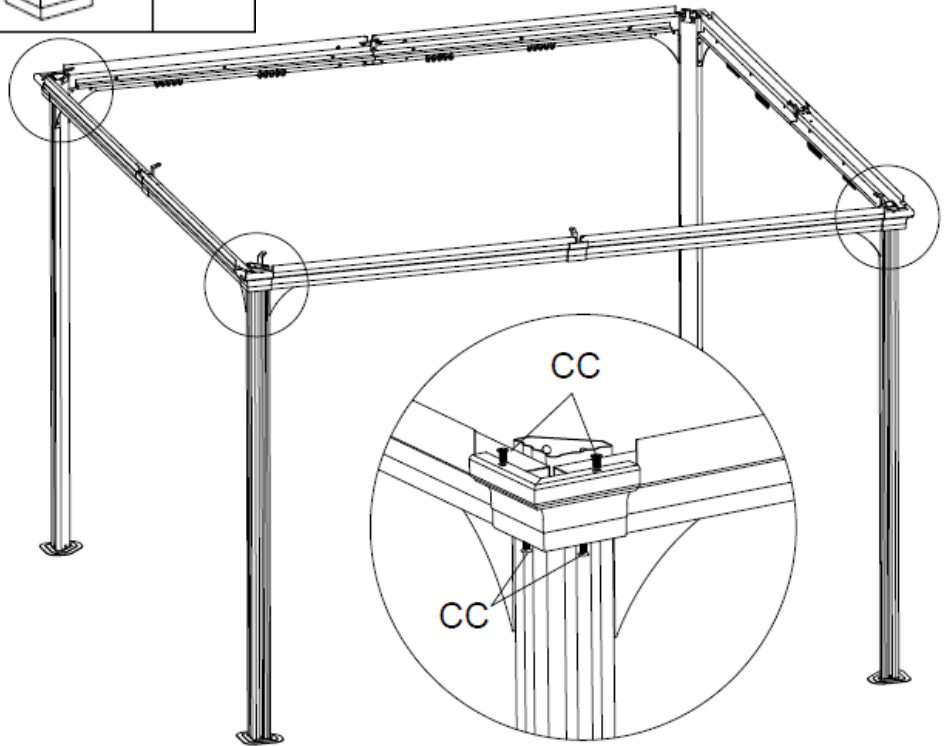

SCHRITT 11

CC	 M5*15	16
P		4





SCHRITT 12

AA	 M6*20	8
BB	 M6*15	8
H		1

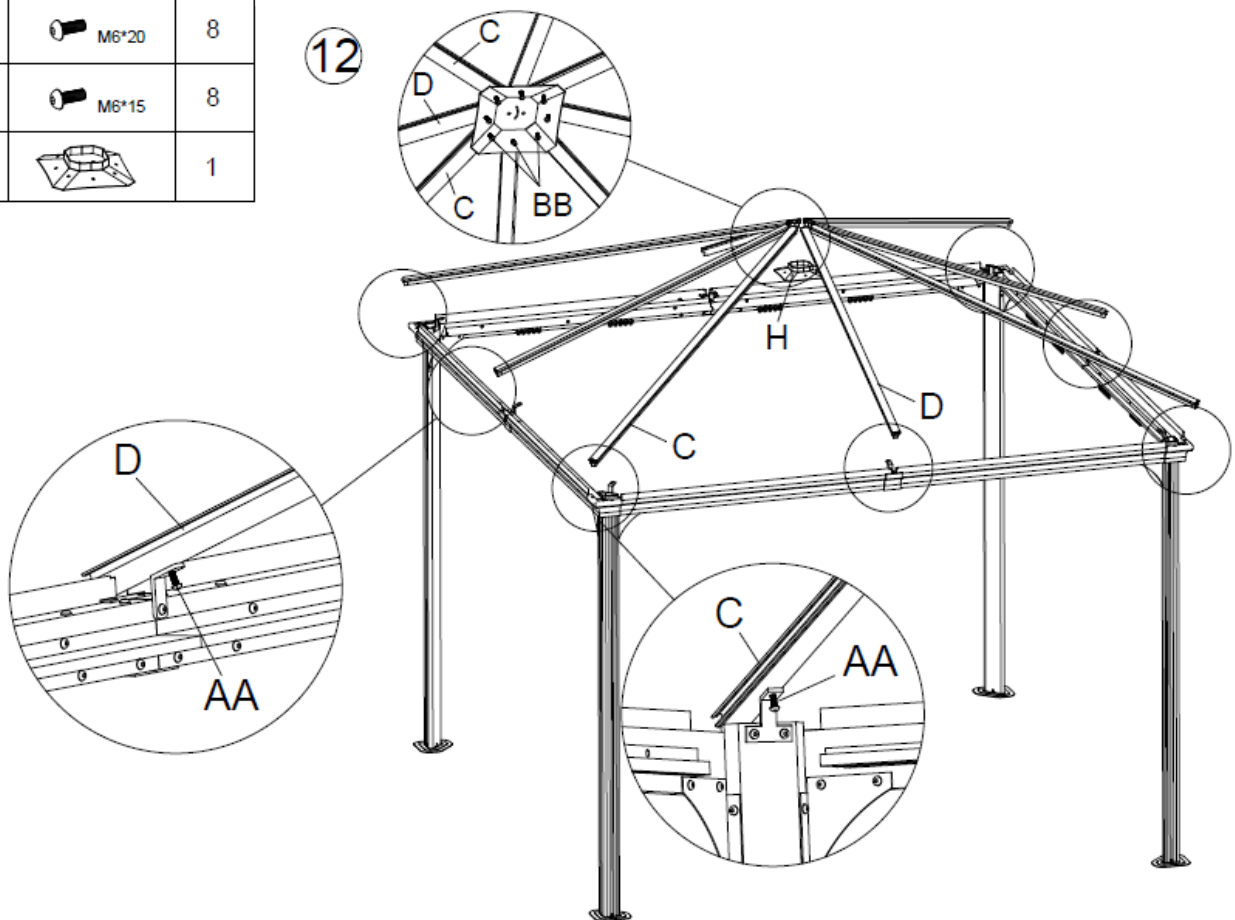
12



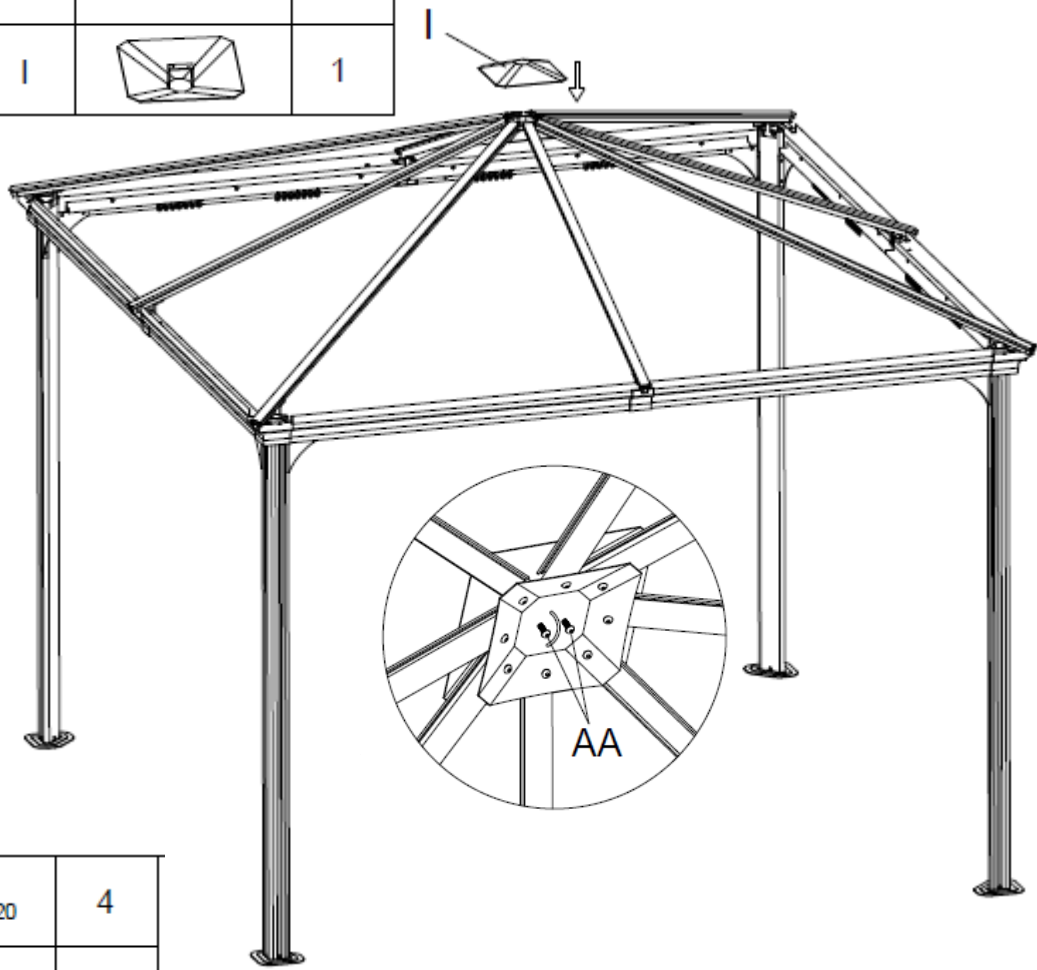

SCHRITT 13

AA	 M6*20	2
I		1



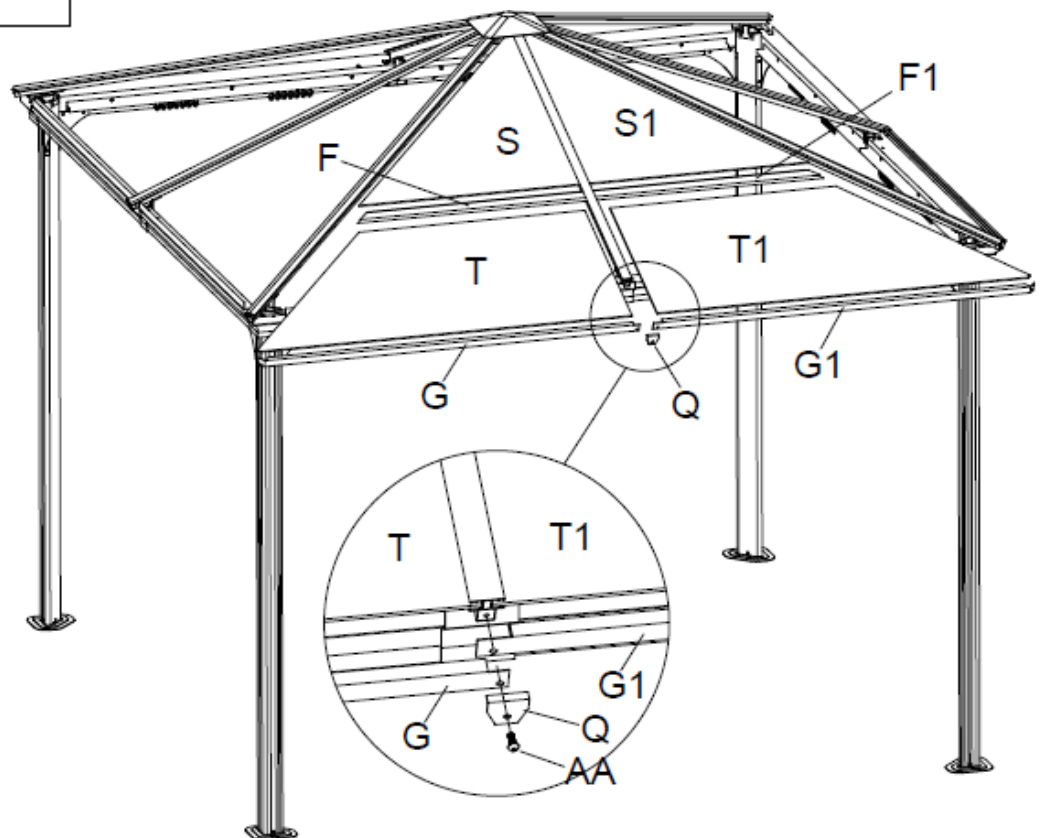
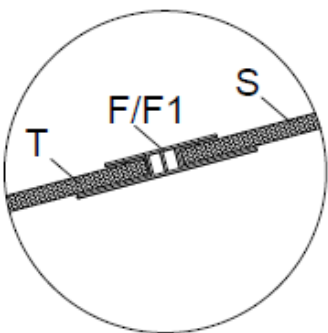
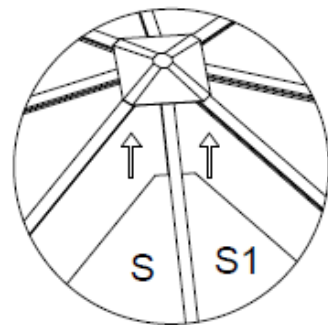

SCHRITT 14

AA	 M6*20	4
Q		4



SCHRITT 15

AA	 M6*20	4
R		4

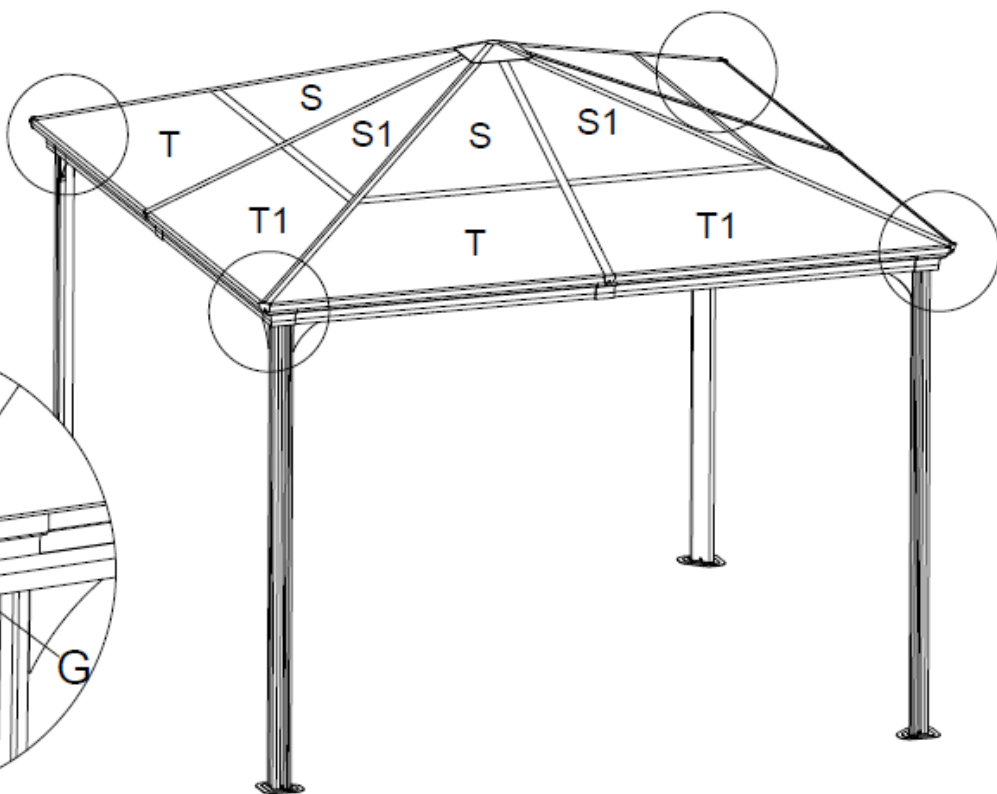
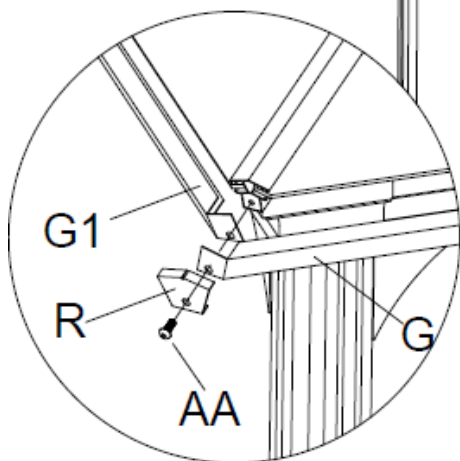

SCHRITT 16

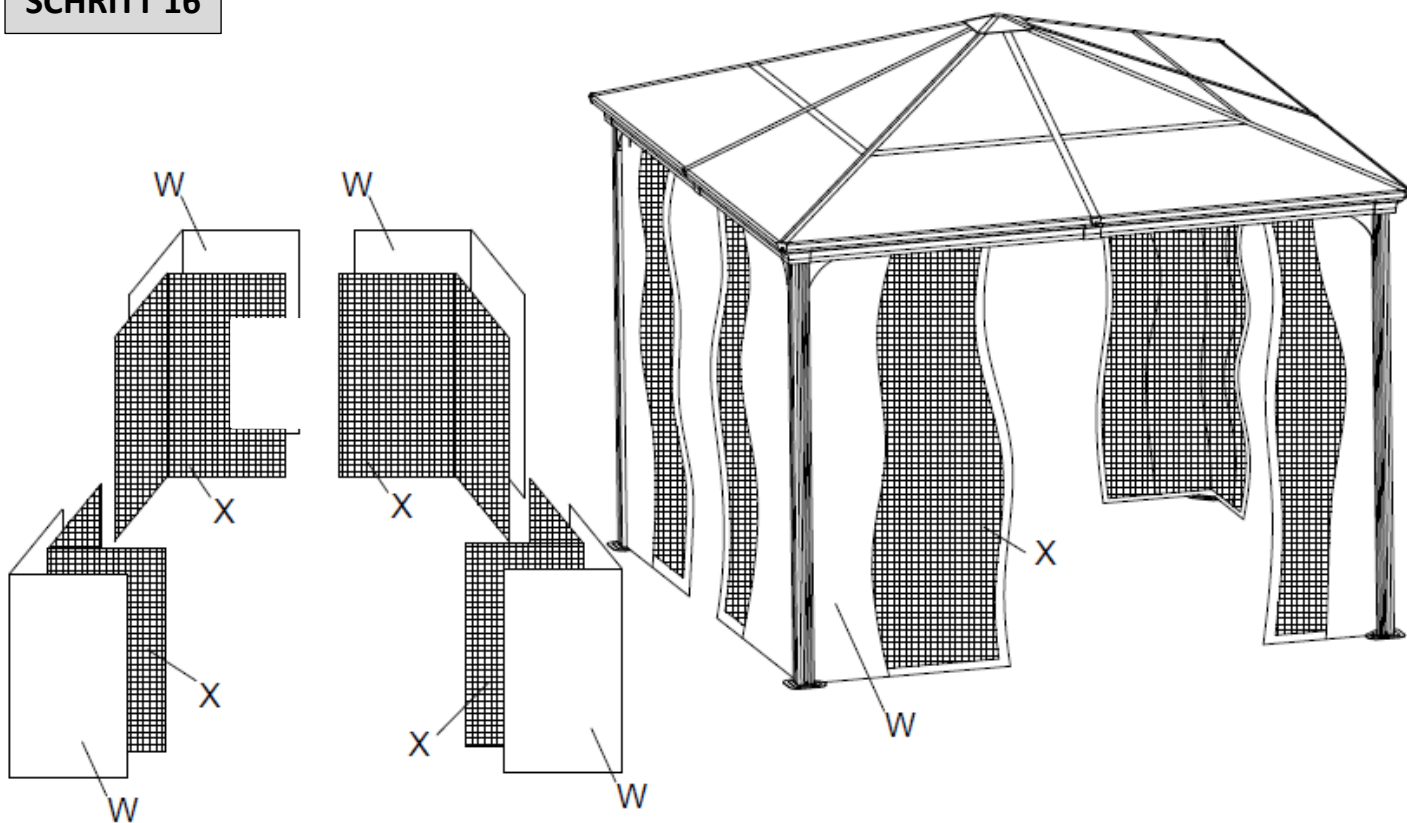



Sicherheitshinweise:

Wir empfehlen den Pavillon am Boden zu verankern.

Hohe Schneelasten auf dem Pavillon sind zwingend zu vermeiden!
Befreien Sie das Dach bei Schneefall unverzüglich vom Schnee.



KBW Trading GmbH
Gewerbering 2
88518 Herbertingen
Deutschland
Tel: 07586-921160
Fax: 07586-9211616
E-Mail: info@jet-line.de
www.jet-line.de

