



GARTENPAVILLON „TANEO“

Artikel-Nr.: 23014

300 x 300 x 264 cm





























- AUFBAUANLEITUNG -



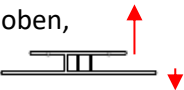

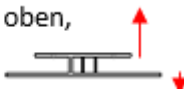

***Installationsvideos und Aufbauanleitungen
zu unseren Produkten finden Sie
in unserem Shop beim jeweiligen Produkt***



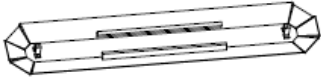

***Weitere Produkte für Ihren Garten
finden Sie unter
www.jet-line.de***

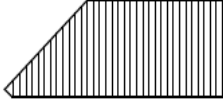
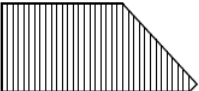
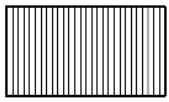
Teile-Liste

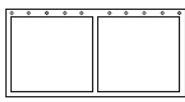
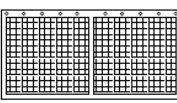
Nr.	Abb.	Bezeichnung	Stz.
A			4
B			2
B1			2
B2			2
B3			2
C			4
D			6
E			2
E1			2
E2			2
E3			2
F		Kurze Seiten nach oben, lange nach unten 	4
F1		Kurze Seiten nach oben, lange nach unten 	4
F2		Kurze Seiten nach oben, lange nach unten 	2
G			4

Nr.	Abb.	Bezeichnung	Stz.
G1	 F		4
G2	 F		2
H			1
I			1
J			4
K			4
K1			4
L			4
M			6
N			4
O			4
P			4
Q			6
R			4
S			4

Nr.	Abb.	Bezeichnung	Stz.
S1			4
T			4
T1			4
U			4
V			96
W			4
X			4

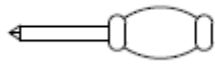
AA		Schraube M6x20	72
BB		Schraube M6x15	100
CC		Schraube M5x15	24
DD		Schraube M5x15	4
EE		4 mm	2
FF			1

Aufbauanleitung

SCHRITT 1

BB		M6*15	16
----	---	-------	----

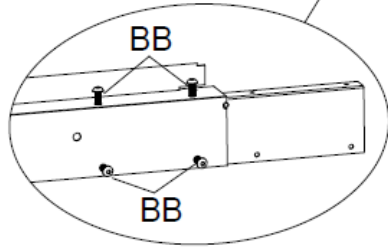
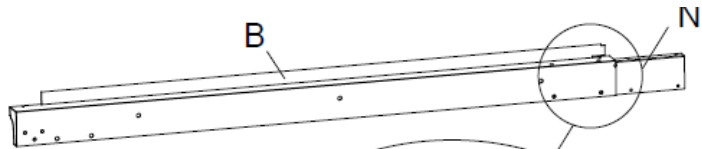

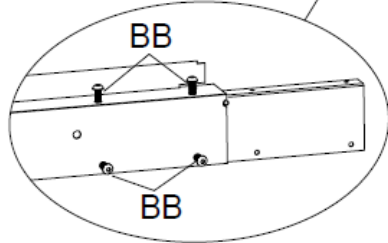
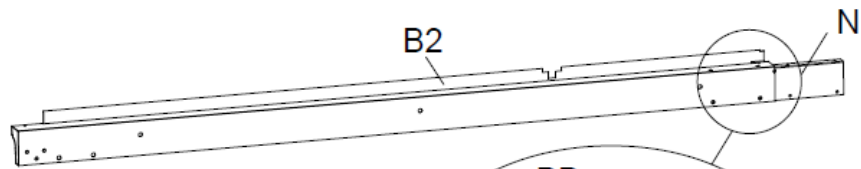

X2



X2

SCHRITT 2

AA		M6*20	2
BB		M6*15	18
M			2

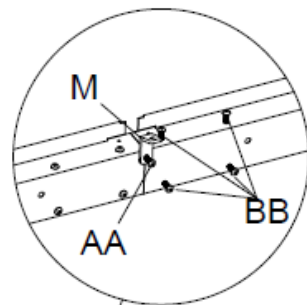

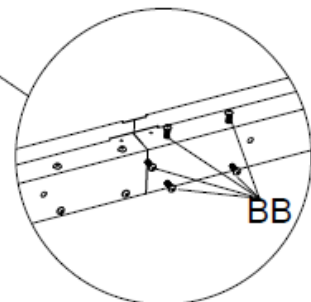
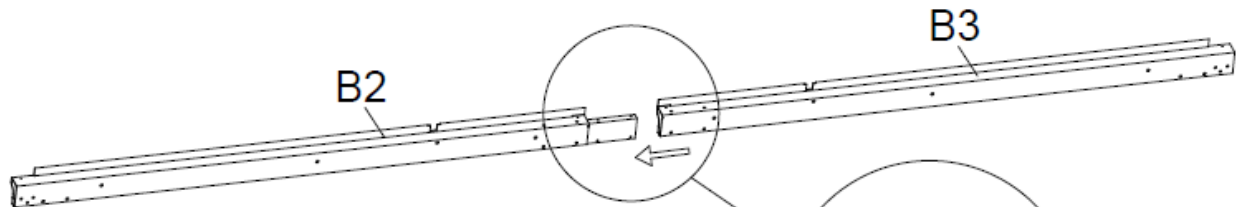
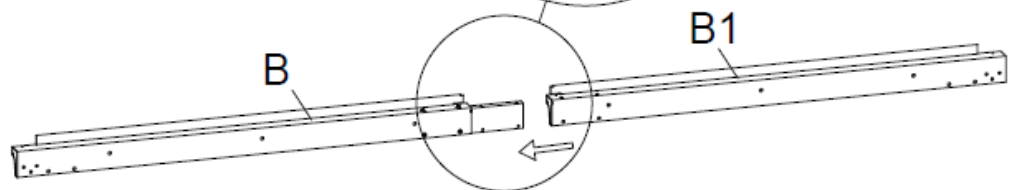

X2



X2

SCHRITT 3

CC	 M5*15	8
DD	 M5*15	4
O		4

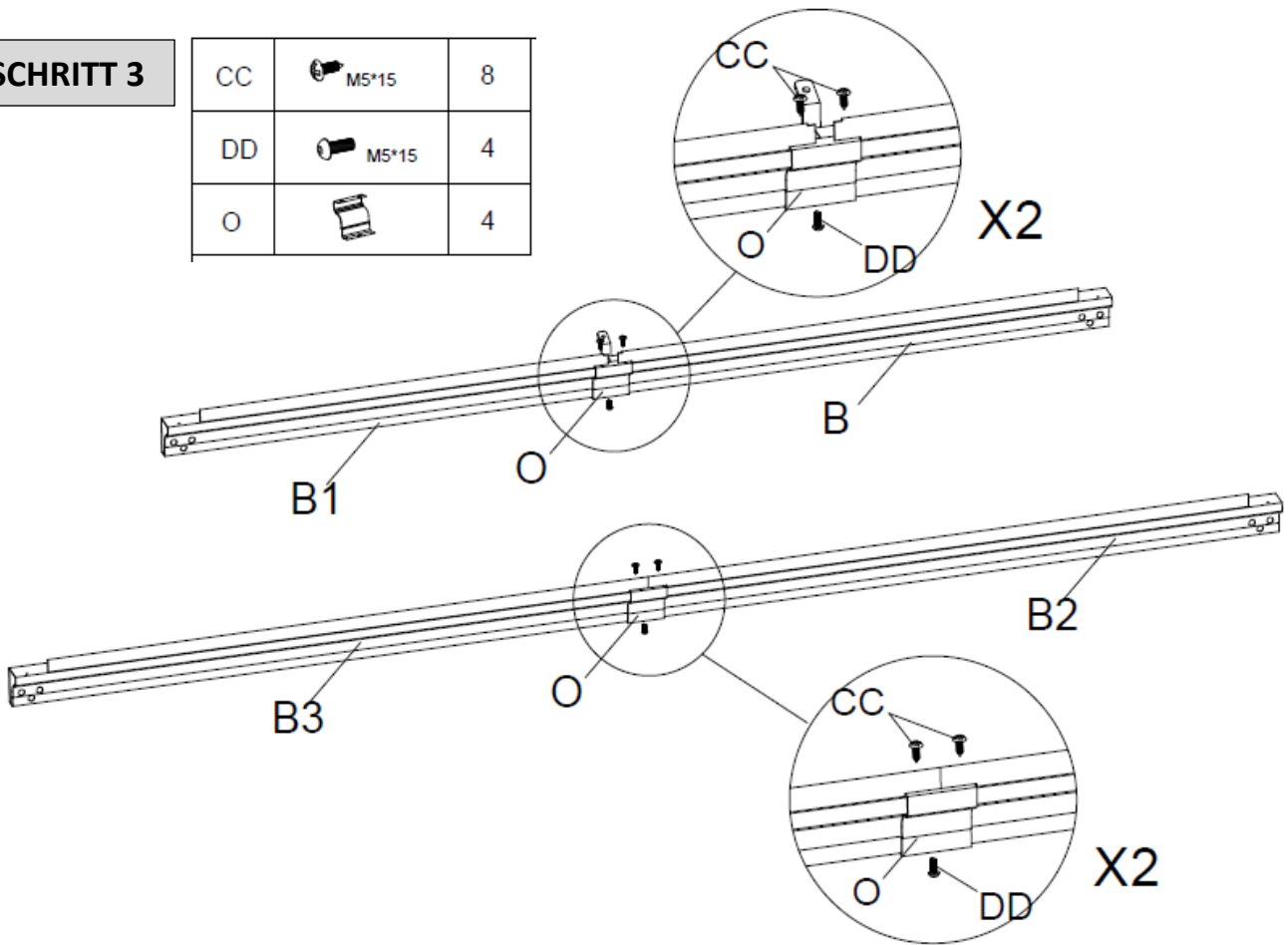

SCHRITT 4

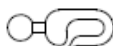
V		96
---	---	----

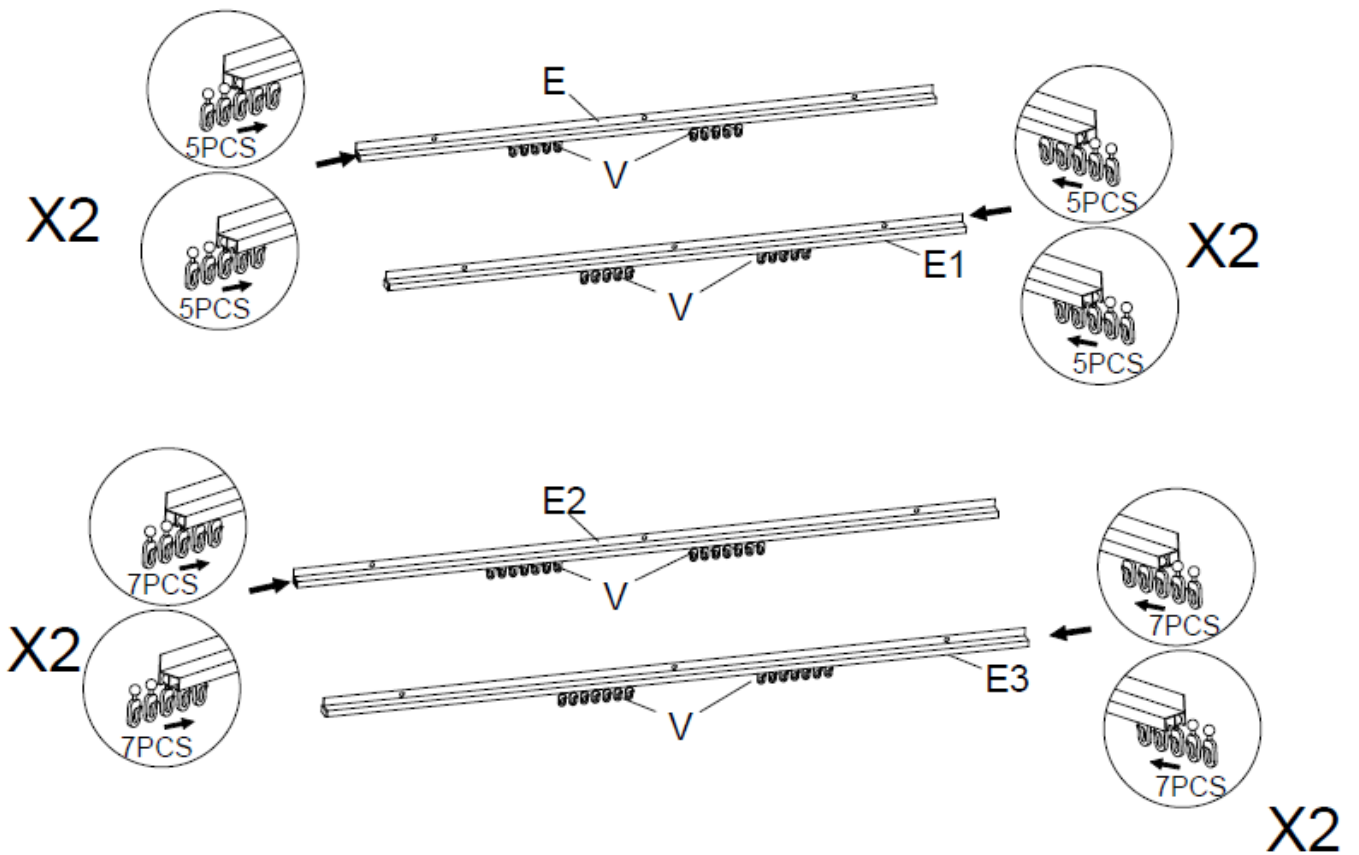

SCHRITT 5

BB

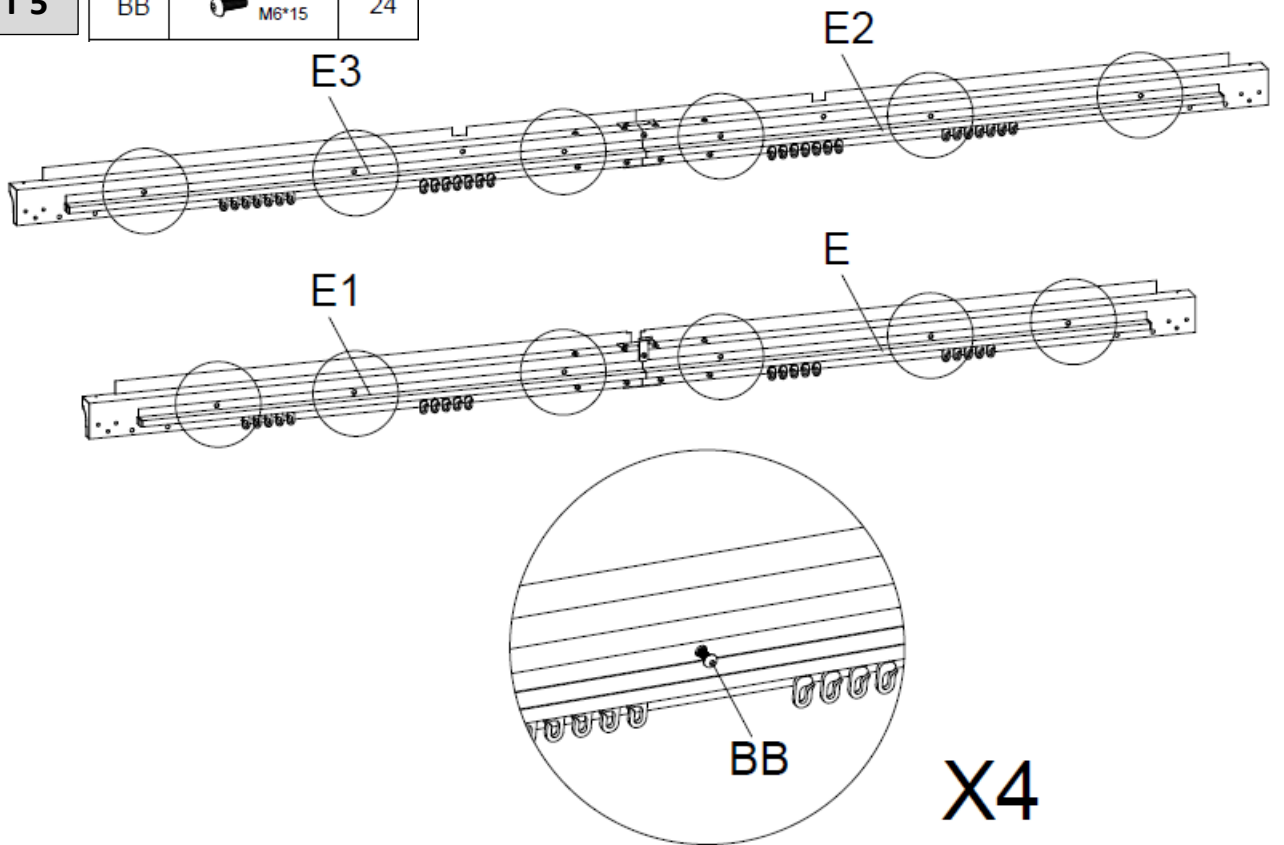

24

**X4****SCHRITT 6**

AA

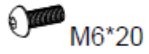

20

L



4

J

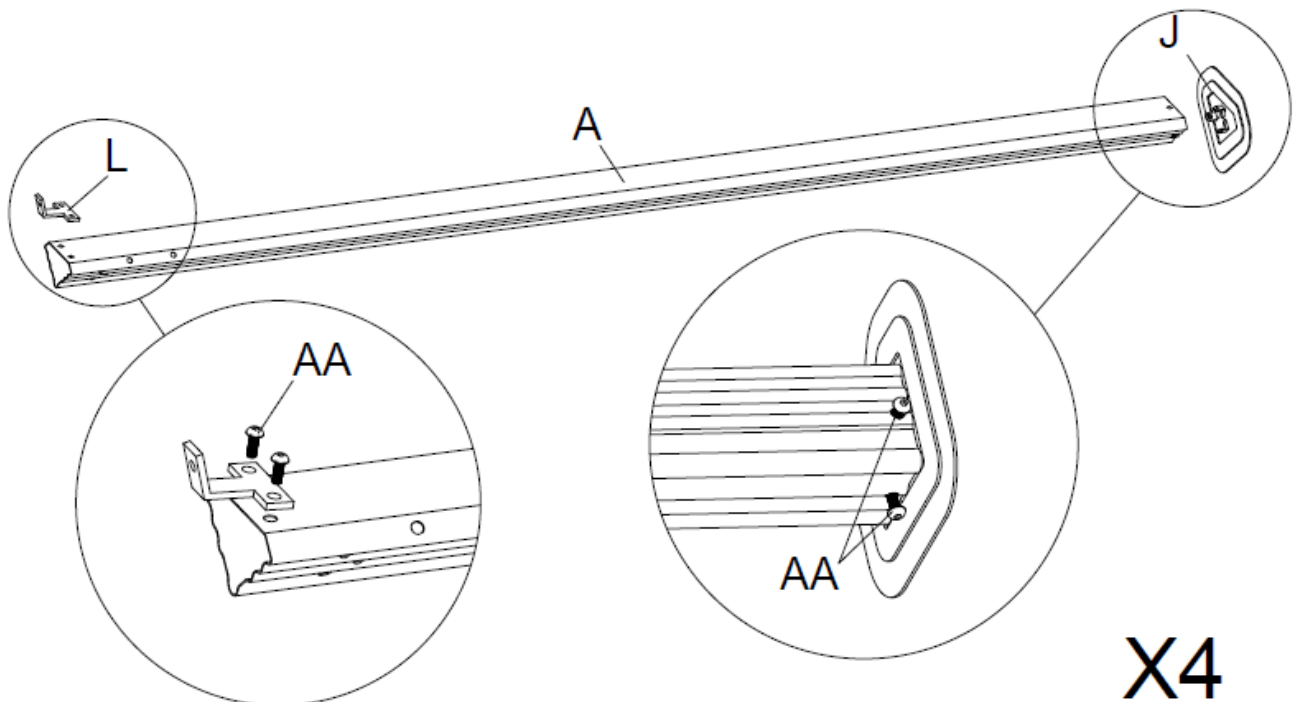

4

**X4**

SCHRITT 7

AA

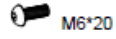

12

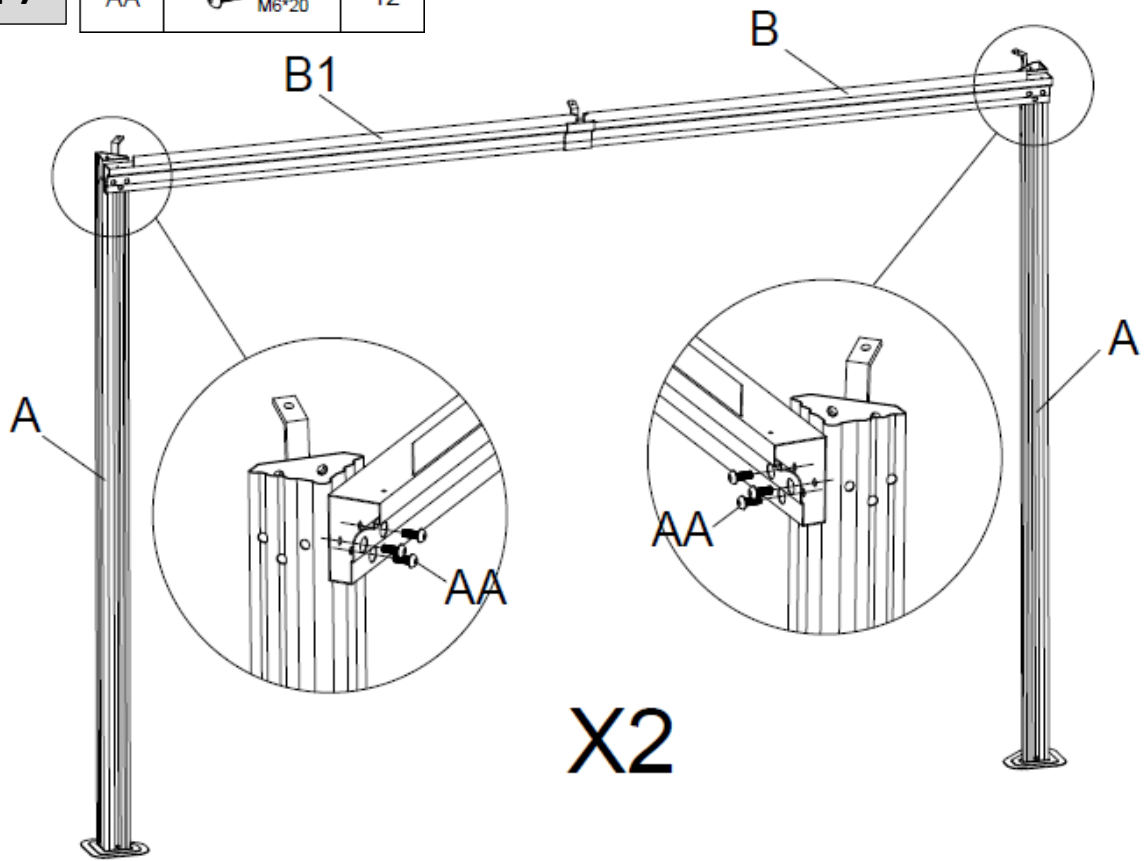

SCHRITT 8

BB



16

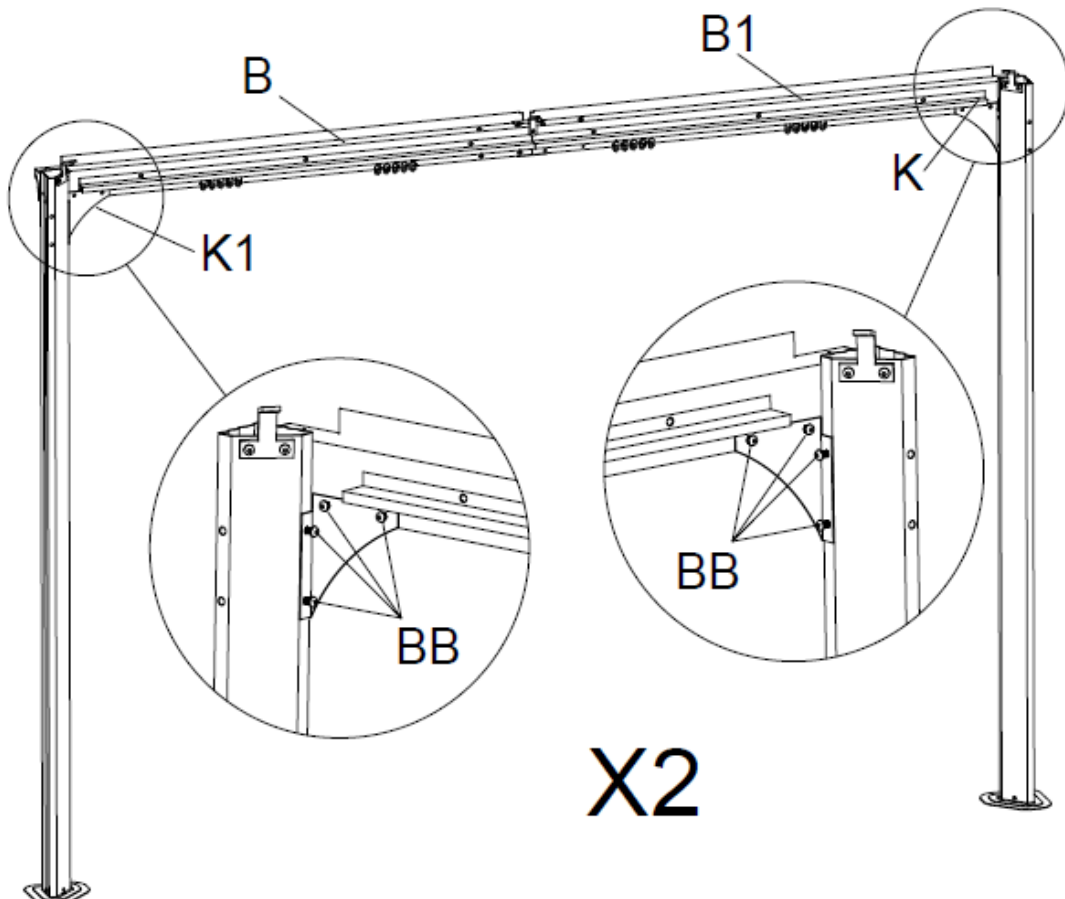

SCHRITT 9

AA

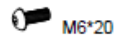

12

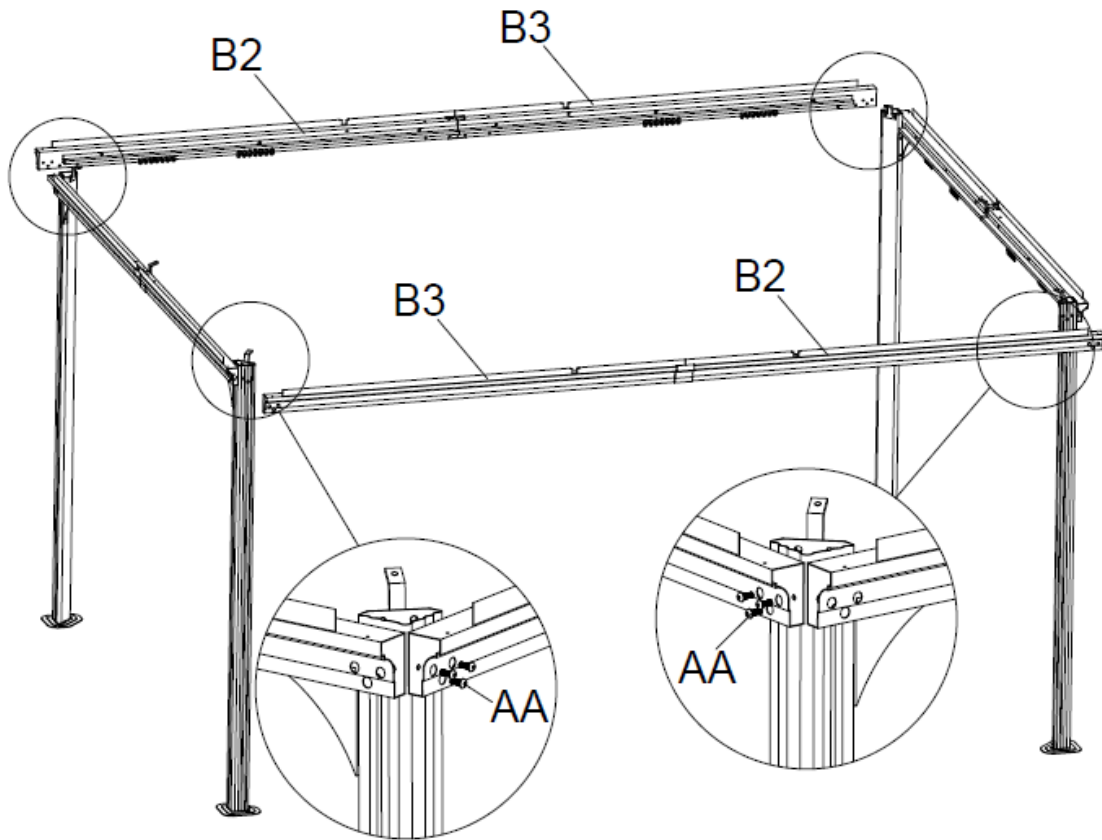
**SCHRITT 10**

AA



4

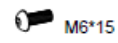

BB

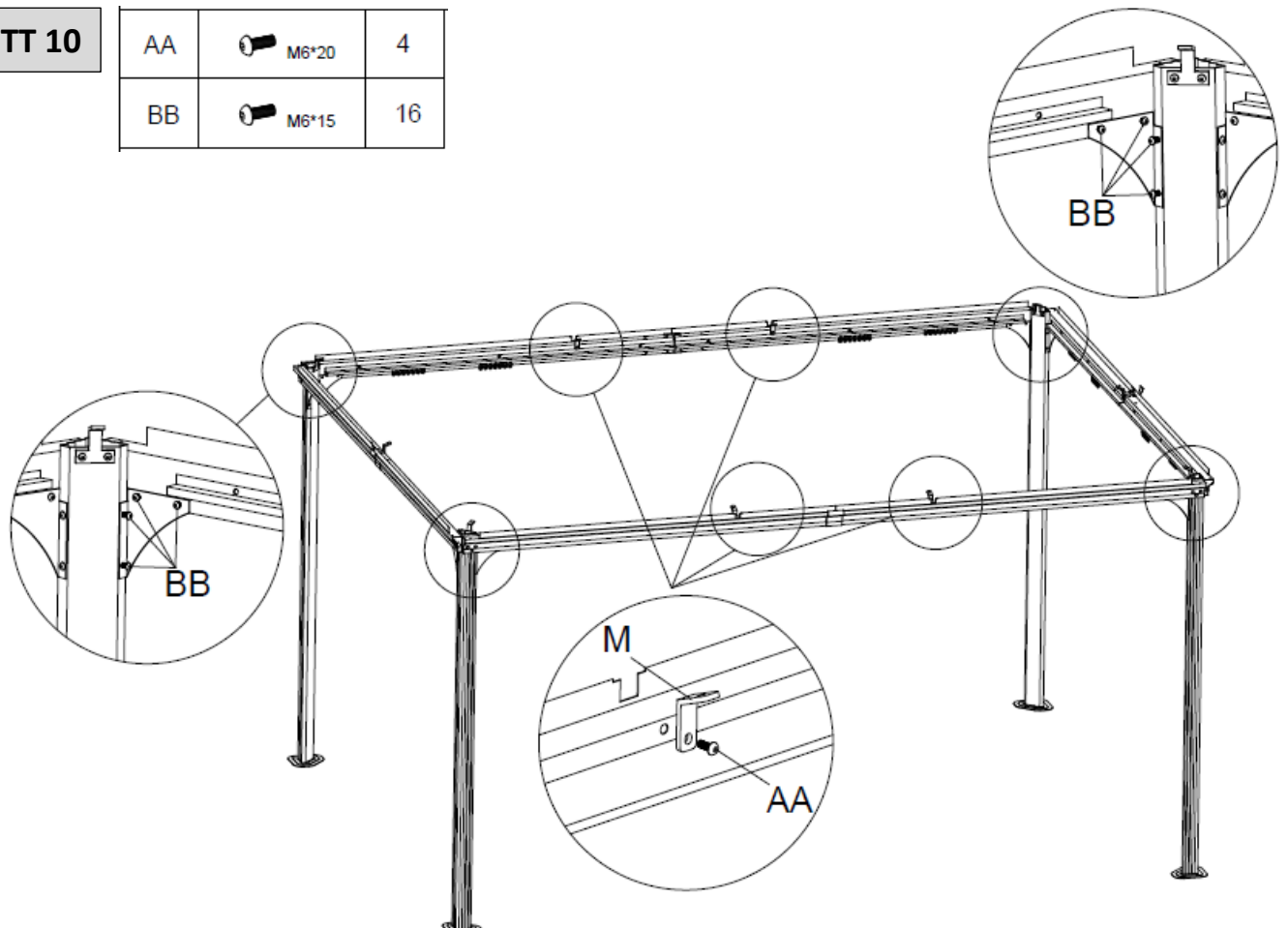

16



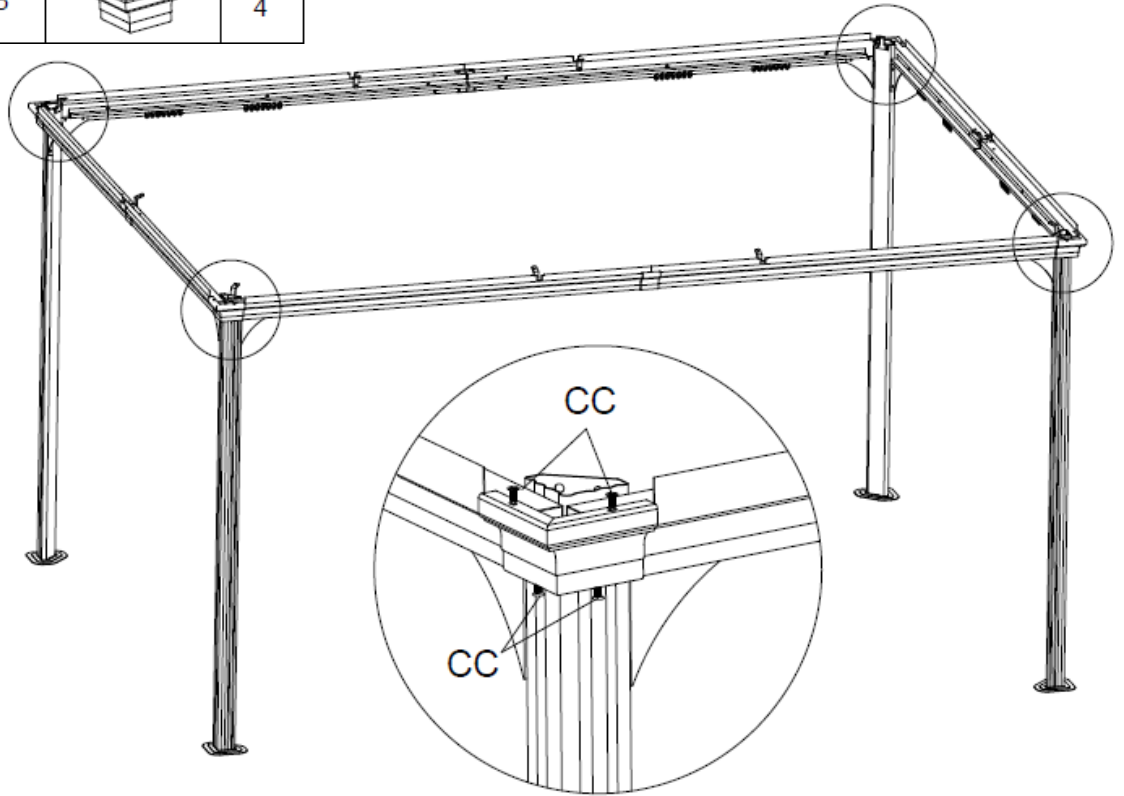

SCHRITT 11

CC	 M5*15	16
P		4



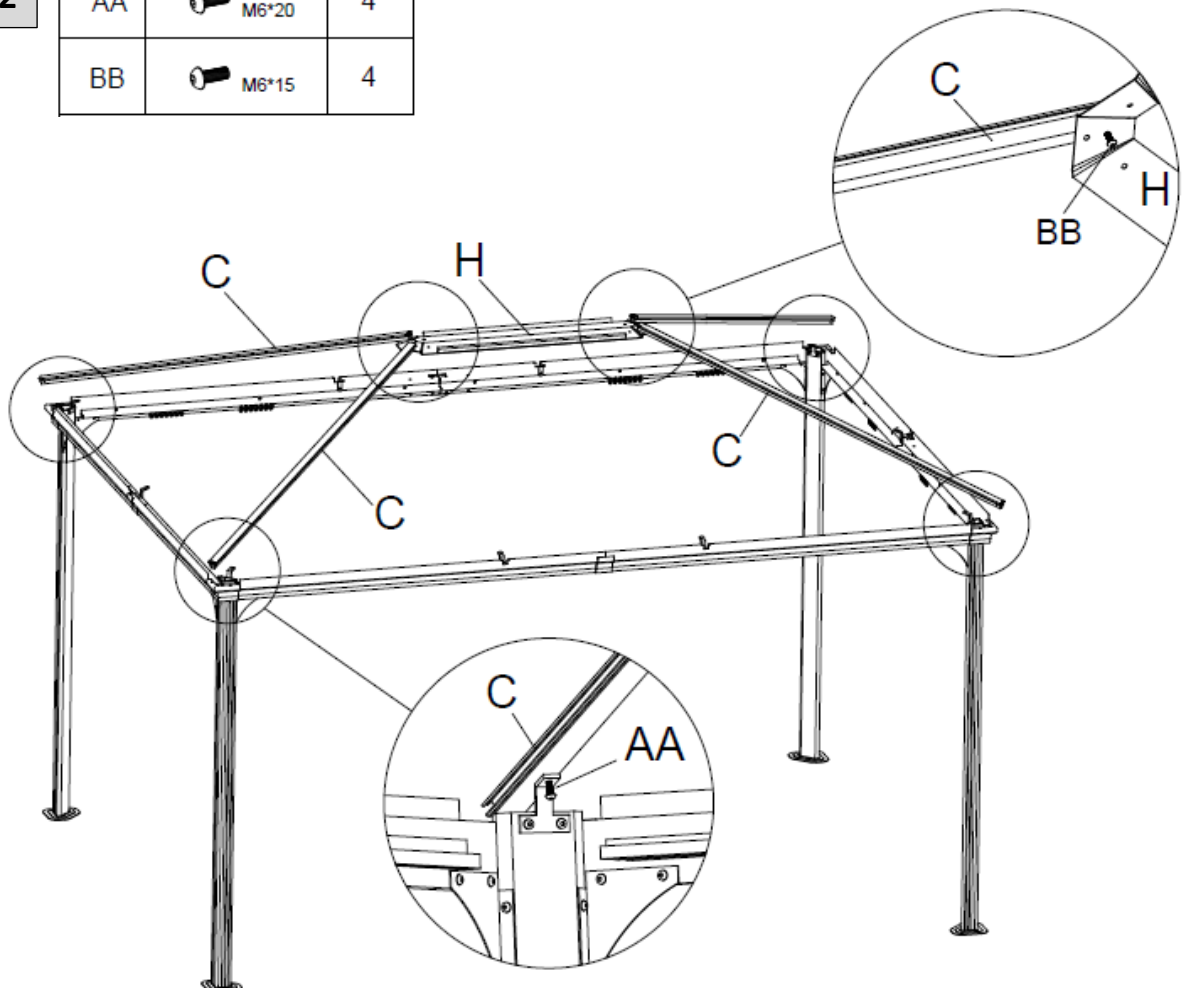

SCHRITT 12

AA	 M6*20	4
BB	 M6*15	4



SCHRITT 13

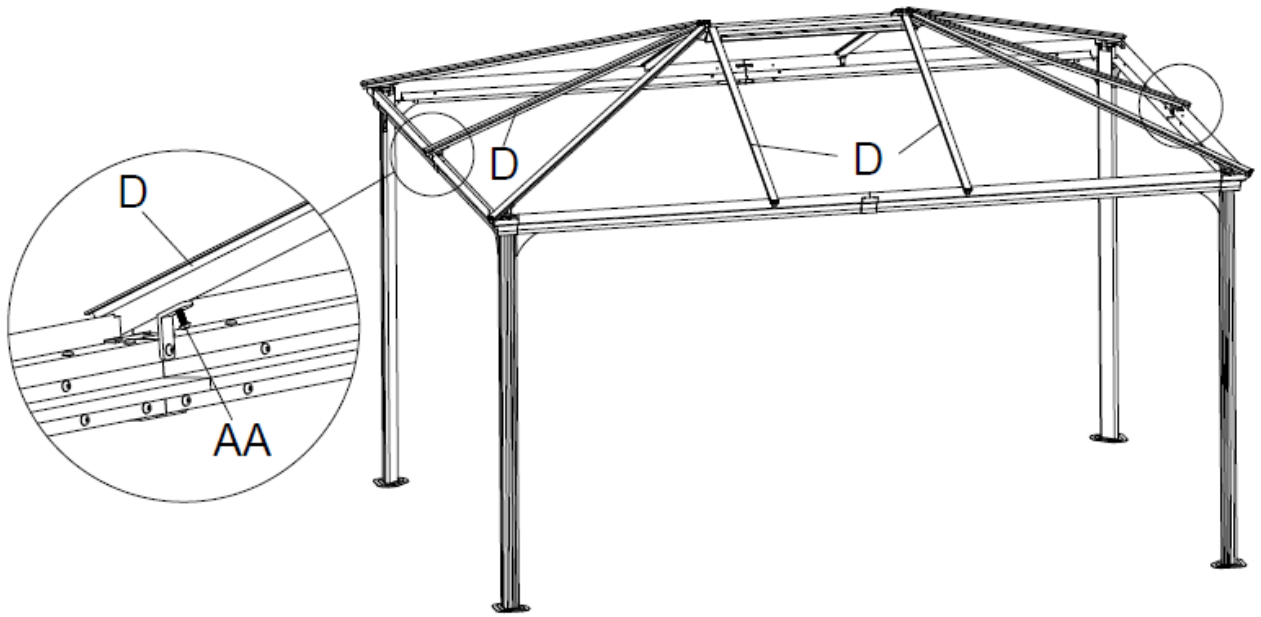
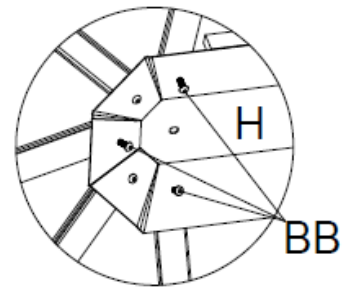

AA	 M6*20	6
BB	 M6*15	6

**SCHRITT 14**

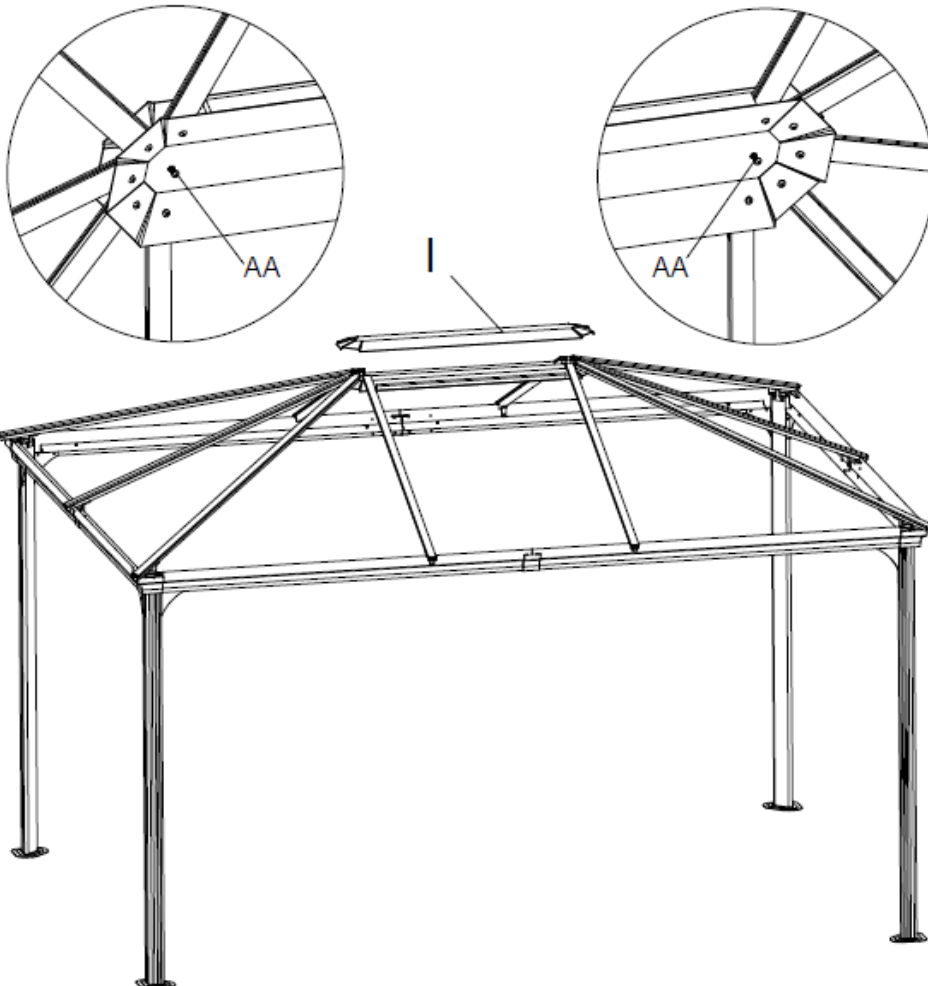
AA	 M6*20	2
----	---	---



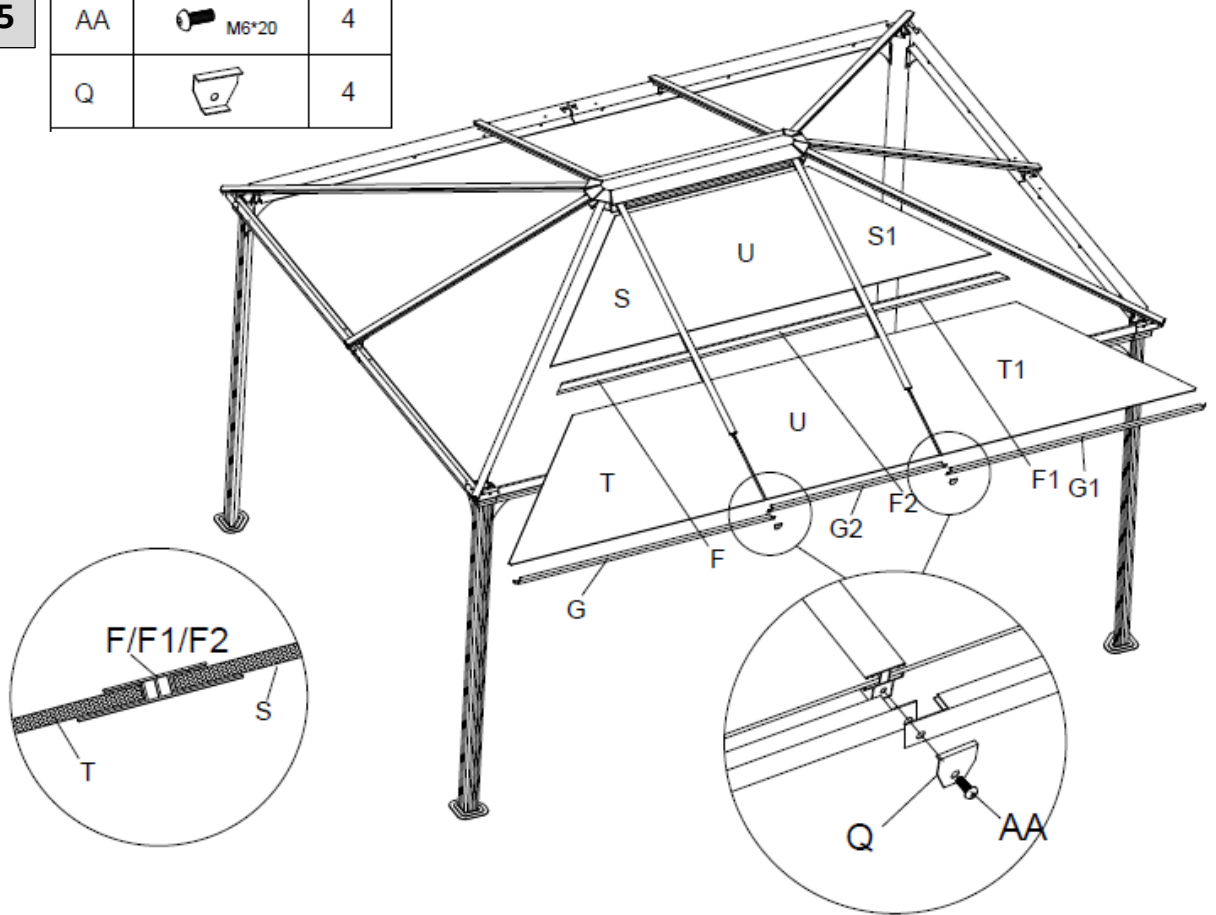

SCHRITT 15

AA	 M6*20	4
Q		4



SCHRITT 16

AA	 M6*20	6
Q		2
R		4

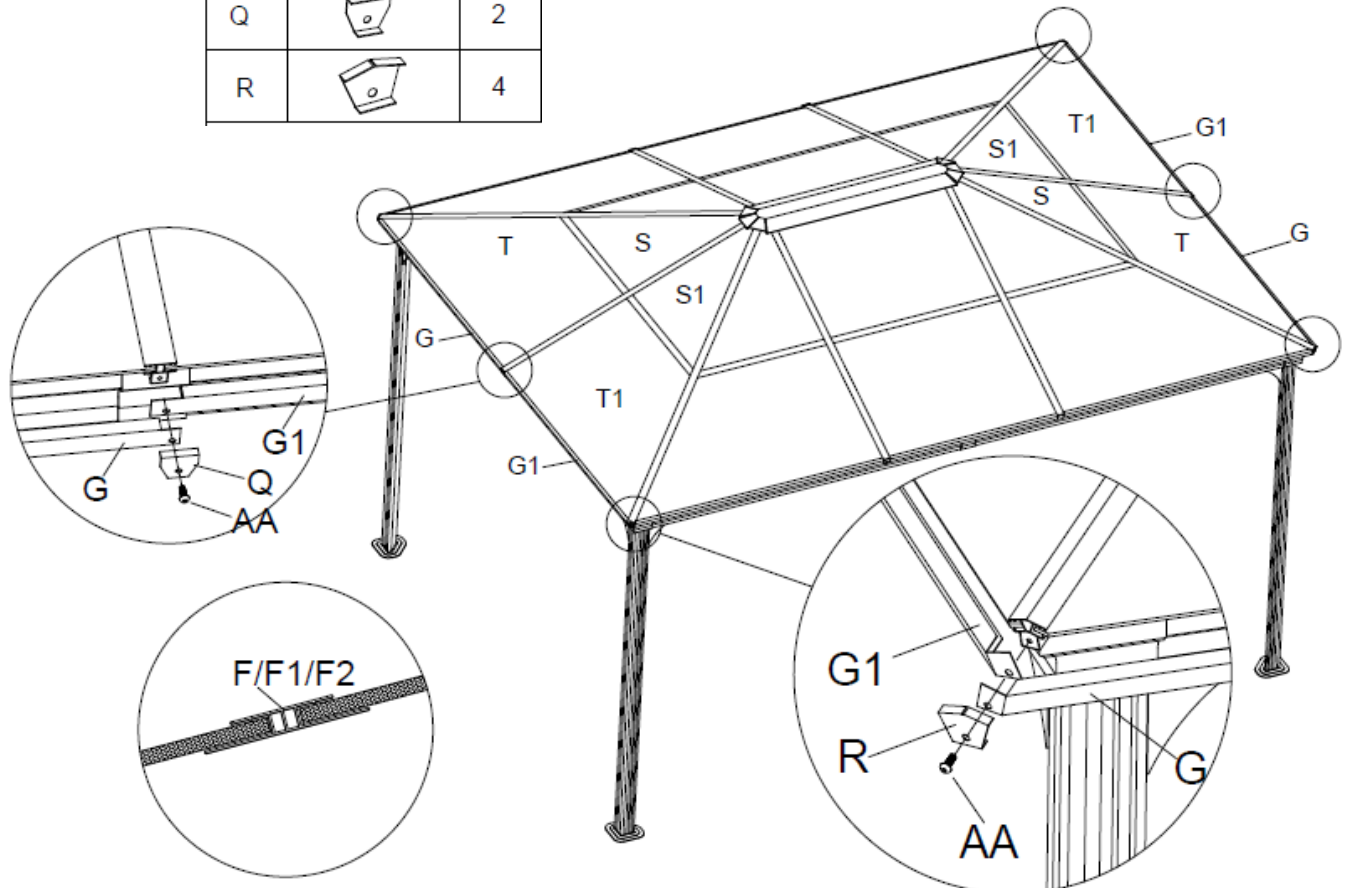

SCHRITT 17

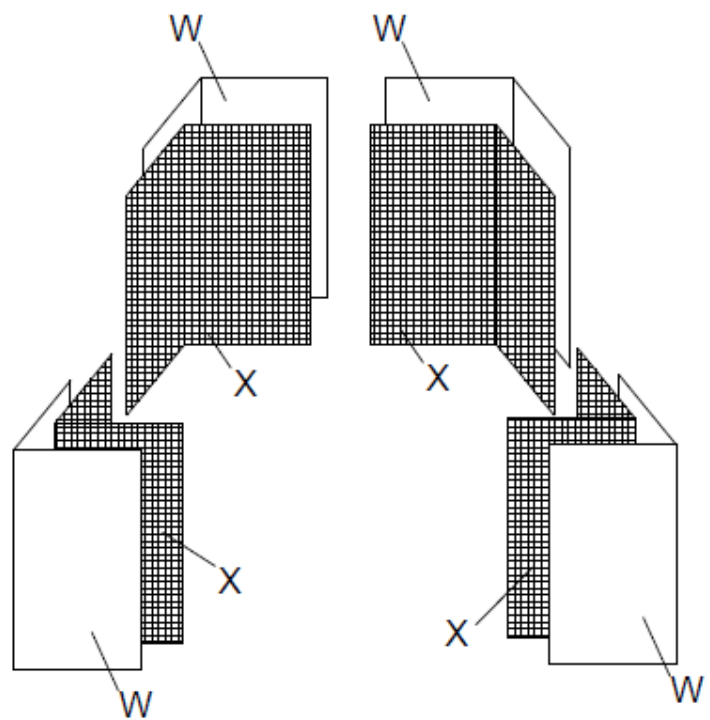
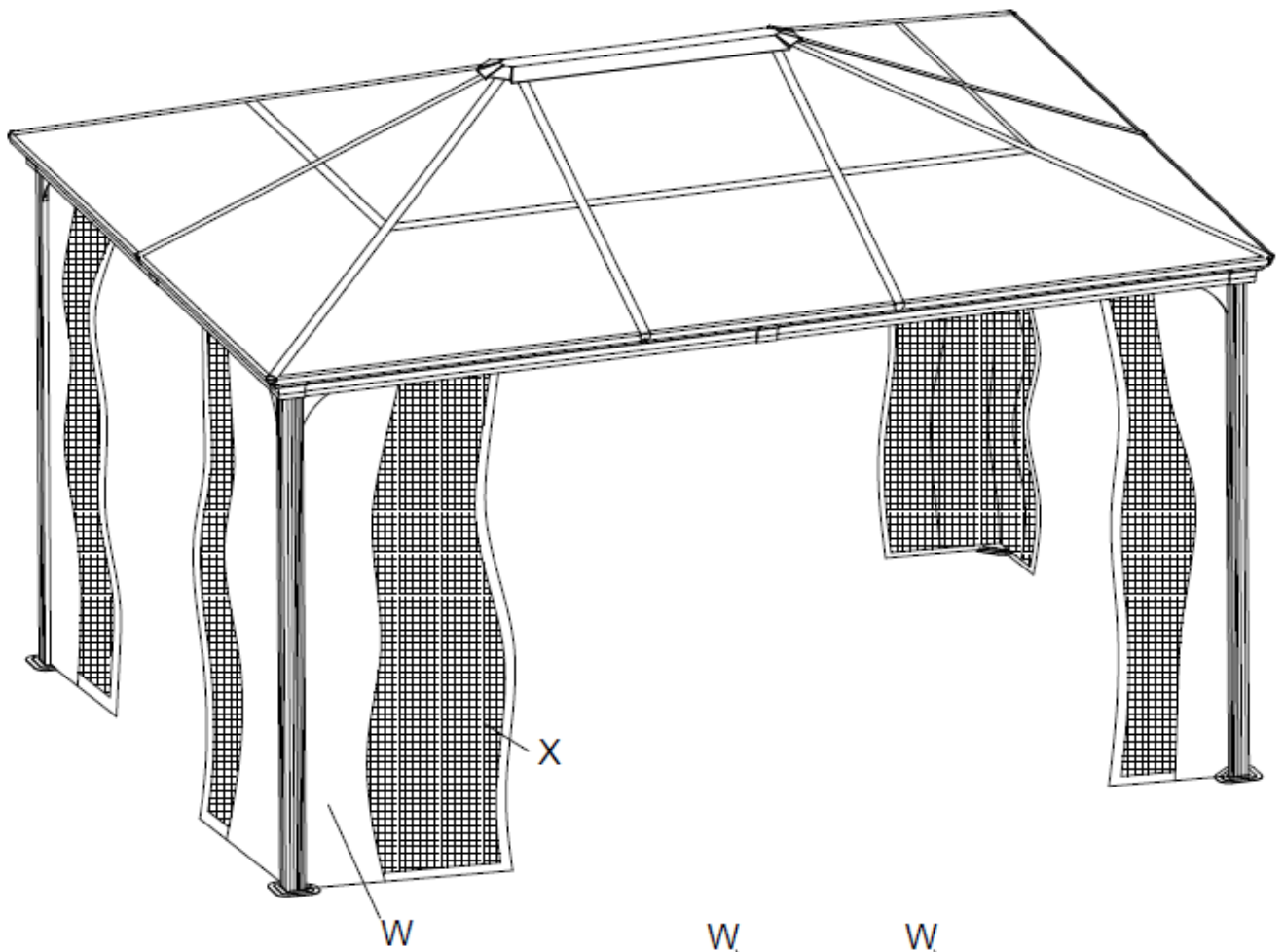



Sicherheitshinweise:

Wir empfehlen den Pavill  Boden zu verankern.

Hohe Schneelasten auf dem Pavillon sind zwingend zu vermeiden!
Befreien Sie das Dach bei Schneefall unverzüglich vom Schnee.



KBW Trading GmbH
 Gewerbering 2
 88518 Herbertingen
 Deutschland
 Tel: 07586-921160
 Fax: 07586-9211616
 E-Mail: info@jet-line.de
www.jet-line.de

