

Installation/User Manual

HERF-1200 HERF-1600 HERF-1800

MICROINVERTER

Ver:1.2,2023-01

About Microinverter

This system is composed of a group of Microinverters that convert direct current (DC) into alternating current (AC) and feeds it into the public grid. The system is designed for the incorporation of one Microinverter for four photovoltaic modules. Each Microinverter works independently that guarantees the maximum power generation of each photovoltaic module. This setup enables user to control the production of a single photovoltaic module directly, consequently improving the flexibility and reliability of the system.

About the Manual

This manual contains important instructions for the HERF-1200/HERF-1600/HERF-1800 Microinverter and must be read in its entirety before installing or commissioning the equipment. For safety, only qualified technician, who has received training or has demonstrated skills can install and maintain this Microinverter under the guide of this document.

Other Information

Product information is subject to change without notice. User manual will be updated frequently, please refer to HERF official website at <https://www.estarpower.com/microinverters> /for the latest version.

Table of Contents

- 1. Important Safety Instructions 3
 - 1.1 Safety Instructions 3
 - 1.2 Radio Interference Statement 4
 - 1.3 The Meaning of Symbols 5
- 2. Microinverter System Introduction 6
 - 2.1 About 4 in 1 Unit 6
 - 2.2 Microinverter Highlights 6
 - 2.3 Terminals Introduction 7
- 3. About Function 8
 - 3.1 Work Mode 8
- 4. About Installation 9
 - 4.1 Accessories 9
 - 4.2 Installation Precaution 9
 - 4.3 Space Distance Required 10
 - 4.4 Preparation 10
 - 4.5 Installation Steps 11
- 5. Troubleshooting 17
 - 5.1 Status LED Indicator 17
 - 5.2 On-site Inspection (For qualified installer only) 17
 - 5.3 Routine Maintenance 18
- 6. Decommissions 19
 - 6.1 Decommissions 19
 - 6.2 Storage and Transportation 19
 - 6.3 Disposal 19
- 7. Technical Data 21
 - 7.1 DC Input 21
 - 7.2 AC Output 21
 - 7.3 Efficiency, Safety and Protection 22
 - 7.4 Mechanical Data 22
 - 7.5 Features 22
- Appendix 1: 23
 - Installation Map 23
- Appendix 2: 24
 - WIRING DIAGRAM – 230VAC SINGLE PHASE: 24
 - WIRING DIAGRAM – 230VAC / 400VAC THREE PHASE: 25

1. Important Safety Instructions

This manual contains important instructions to follow during installation and of the Photovoltaic Grid-connected Inverter (Microinverter). To reduce the risk of electrical shock and ensure the safe installation and operation of the Microinverter, the following symbols appear throughout this document to indicate dangerous conditions and important safety instructions.

Specifications subject to change without notice - please ensure you are using the latest manual found at the manufacturer website.

WARNING: This indicates a situation where failure to follow instructions may cause a serious hardware failure or personnel danger if not applied appropriately. Use extreme caution when performing this task.

****Note: This indicates information that is important for optimized microinverter operation. Follow these instructions strictly.***

1.1 Safety Instructions

- ✓ DO NOT disconnect the PV module from the Microinverter without disconnecting the AC power.
- ✓ Only qualified professionals should install and/or replace the Microinverters.
- ✓ Perform all electrical installations in accordance with local electrical codes.
- ✓ Before installing or using the Microinverter, please read all instructions and cautionary markings in the technical documents and on the Microinverter system and the Microinverter solar-array.
- ✓ Be aware that the body of the Microinverter is the heat sink and can reach a temperature of 80°C . To reduce risk of burns, do not touch the body of the Microinverter.

✓ DO NOT attempt to repair the Microinverter. If it fails, contact technical support to obtain an RMA number and start the replacement process. Damaging or opening the Microinverter will void the warranty.

✓ Caution!

The external protective earthing conductor is connected to the inverter protective earthing terminal through AC connector.

When connecting, connect the AC connector first to ensure the inverter earthing then do the DC connections.

When disconnecting, disconnect the AC by opening the branch circuit breaker first but maintain the protective earthing conductor in the branch circuit breaker connect to the inverter, then disconnect the DC inputs.

✓ In any circumstance, do not connect DC input when AC connector is unplugged.

✓ Please install isolation switching devices on the AC side of the inverter.









1.2 Radio Interference Statement

CE EMC Compliance: The equipment can comply with CE EMC, which are designed to protect against harmful interference in a residential installation. The equipment could radiate radio frequency energy and this might cause harmful interference to radio communications if not following the instructions when installing and using the equipment. But there is no guarantee that interference will not occur in a particular installation. If this equipment causes harmful interference to radio or television reception, the following measures might resolve the issues:

A) Relocate the receiving antenna and keep it well away from the equipment.

B) Consult the dealer or an experienced radio / TV technical for help. Changes or modifications not expressly approved by the party responsible for compliance may void the user's authority to operate the equipment.

1.3 The Meaning of Symbols

Symbol	Usage
	<p>Treatment</p> <p>To comply with European Directive 2002/96/EC on waste Electrical and Electronic Equipment and its implementation as national law, electrical equipment that has reached the end of its life must be collected separately and returned to an approved recycling facility. Any device no longer required must be returned to an authorized dealer or approved collection and recycling facility.</p>
	<p>Caution</p> <p>Do not come within 8 inches (20cm) of the microinverter for any length of time while it is in operation.</p>
	<p>Danger of high voltages</p> <p>High voltage in the microinverter can cause dangers to life.</p>
	<p>Beware of hot surface</p> <p>The inverter can become hot during operation. Avoid contact with metal surfaces during operation.</p>
	<p>CE mark</p> <p>The inverter complies with the requirements of the Low Voltage Directive for the European Union.</p>
	<p>FCC mark</p> <p>The inverter complies with the FCC standards.</p>
	<p>Caution</p> <p>Risk of electric shock, Energy storage timed discharge.</p>
	<p>Read manual first</p> <p>Please read the installation manual first before installation, operation and maintenance.</p>

2. Microinverter System Introduction

2.1 About 4 in 1 Unit

- “4-in-1 Unit Microinverter” with ultra-wide DC input operating voltage range (16 V–60 V) and low start-up voltage (22 V only).

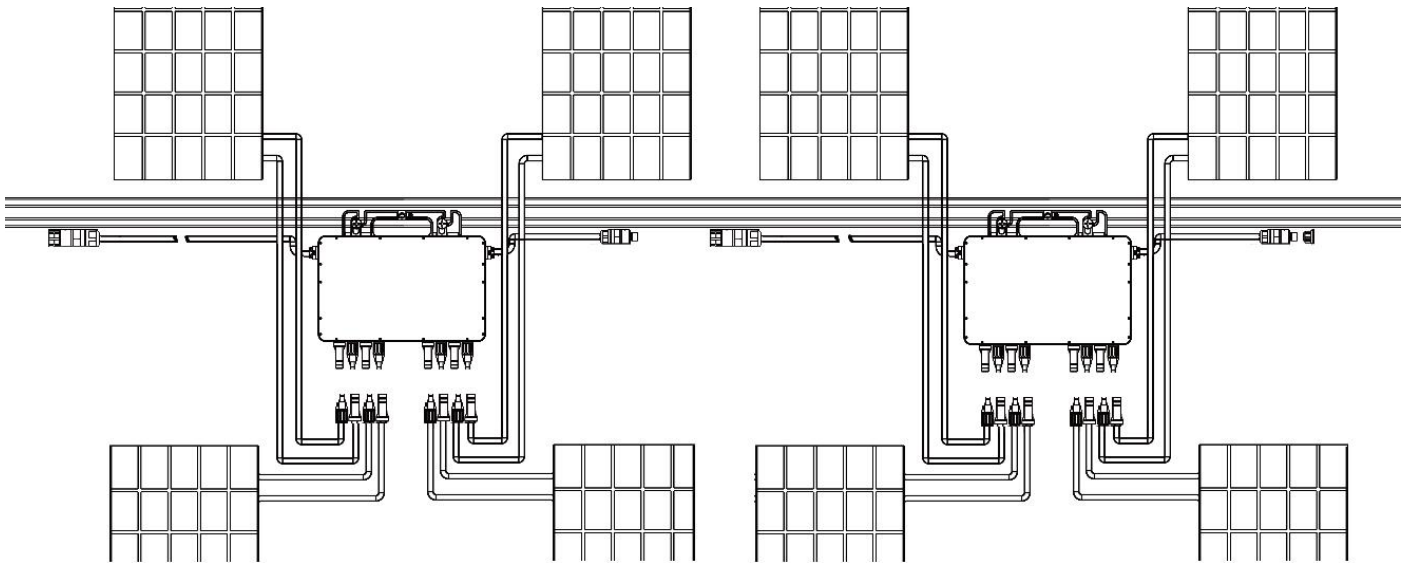

2.2 Microinverter Highlights

- Maximum output power up to 1200W/1600W/1800W; Adapted to 60 & 72 cells PV panels.
- CEC weighted efficiency 96.50%.
- MPPT efficiency 99.5%.
- High reliability: NEMA6 (IP67) enclosure; 6000V surge protection.

2.3 Terminals Introduction

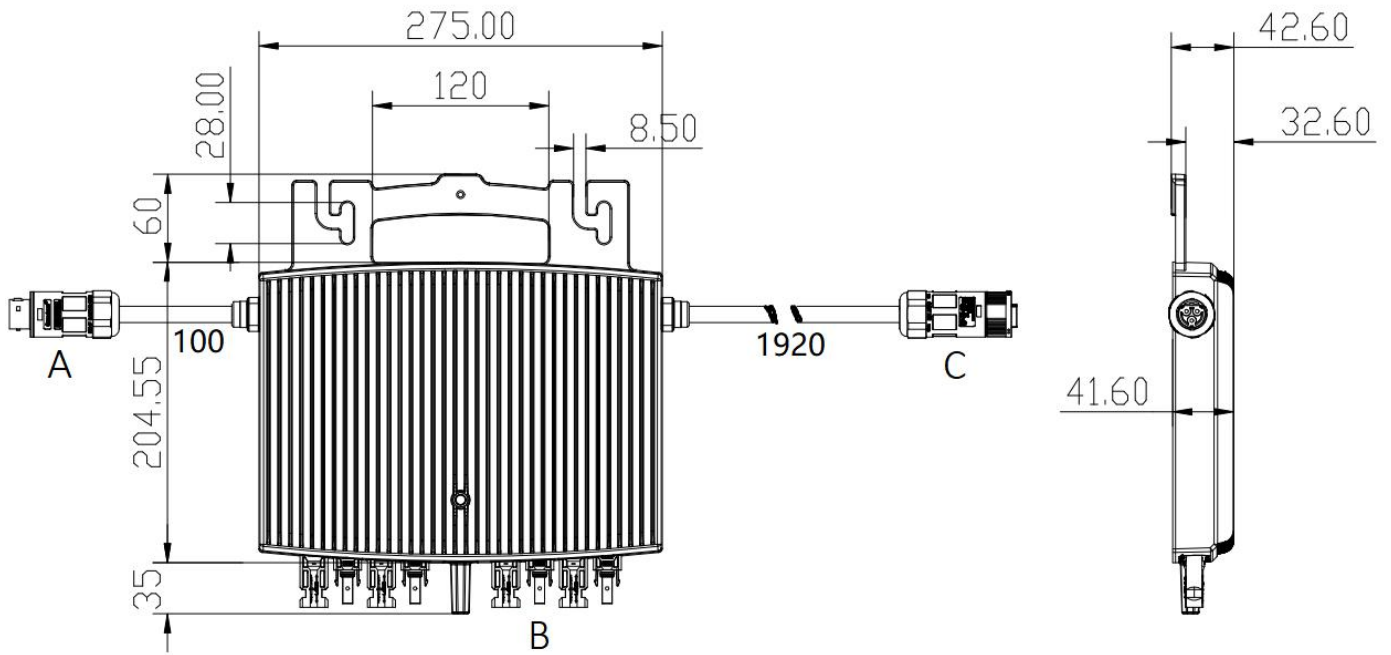

Object	Description
A	AC Connector (Male)
B	DC Connectors
C	AC Connector (Female)

3.About Function

3.1 Work Mode

Normal: Under this mode, Microinverter is operating normally and convert DC power into AC power to support the house loads and feed in to Public Grid.

Zero Export Control: Under this mode Microinverter' s generation is limit base on the current house loads, there will be no extra power feed in to the Public Grid.

Stand by: There are several circumstances that Microinverter will stay in Standby mode:

- The current condition is contradicted with Microinverter operating requirement.
- No house loads or the Export control value has been set as "0" on the DCU under the Zero Export Control mode.

4.About Installation

4.1 Accessories

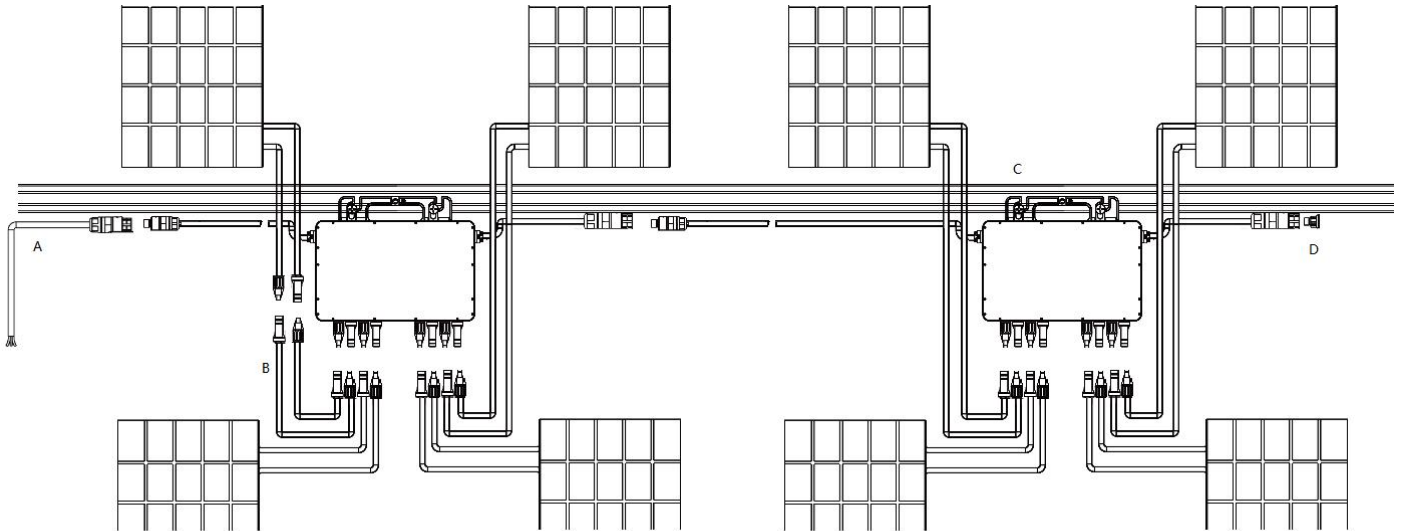

Object	Description
A	AC End Cable (Male), 2m 10AWG Cable, Brown/Black/Yellow-green
B	DC Extension Cable, 1m, Black
C	M8*25 screws
D	AC Male End Cap, IP68
E	Microinverte is incompatible with RCD&RCM

****Note: All accessories above are not included in the package, and need to be purchased separately.***

Please contact our sales representative for the price. (M8 screws need to be prepared by installer-self.)

4.2 Installation Precaution

Please install the Microinverter and all DC connections under the PV module to avoiding direct sunlight, rain exposure, snow layup, UV etc. Allow a minimum of 2 cm of space around the microinverter enclosure to ensure ventilation and heat dissipation.

**Note: For some countries the DCU will be required to meet the local grid regulation (e.g., G98/99 for UK etc.)*

4.3 Space Distance Required

If the microinverters are installed on a concrete roof or steel roof, the communication with the DCU may be slightly affected. Under such installation conditions, it is better for the microinverters to be installed 50cm above the roof. Otherwise, more DCUs may be required to ensure the communication quality between the DCUs and the microinverters.

4.4 Preparation

Installation of the equipment is carried out based on the system design and the place in which the equipment is installed.

- The installation must be carried out with the equipment disconnected from the grid (power disconnect switch open) and with the photovoltaic modules shaded or isolated.
- Referring to the Technical Data to make sure the environmental conditions fit the microinverter' s requirement (degree of protection, temperature, humidity, altitude, etc.)
- To avoid power de-rating due to an increase in the microinverter internal temperature, do not expose it to direct sunlight.
- To avoid overheating, always make sure the air flow around the inverter is not blocked.
- Do not install in places where gasses or flammable substances may be present.
- Avoid electromagnetic interference that can compromise the correct operation of electronic equipment.

When choosing the position of installation, comply with the following conditions:

- Install only on structures specifically conceived for photovoltaic modules (supplied by installation

technicians).

- Install Microinverter underneath of the photovoltaic modules to make sure it works in the shadow. If this condition cannot be met, might trigger the inverter production de-rating.

4.5 Installation Steps

4.5.1 Step 1. Attach Microinverter on Rail.

A) Mark the approximate center of each panel on the frame.

B) Fix the screw on the rail.

C) Hang the microinverter on the screw (as shown in the picture below), and tighten the screw. The black cover side of the microinverter should be facing the panel.

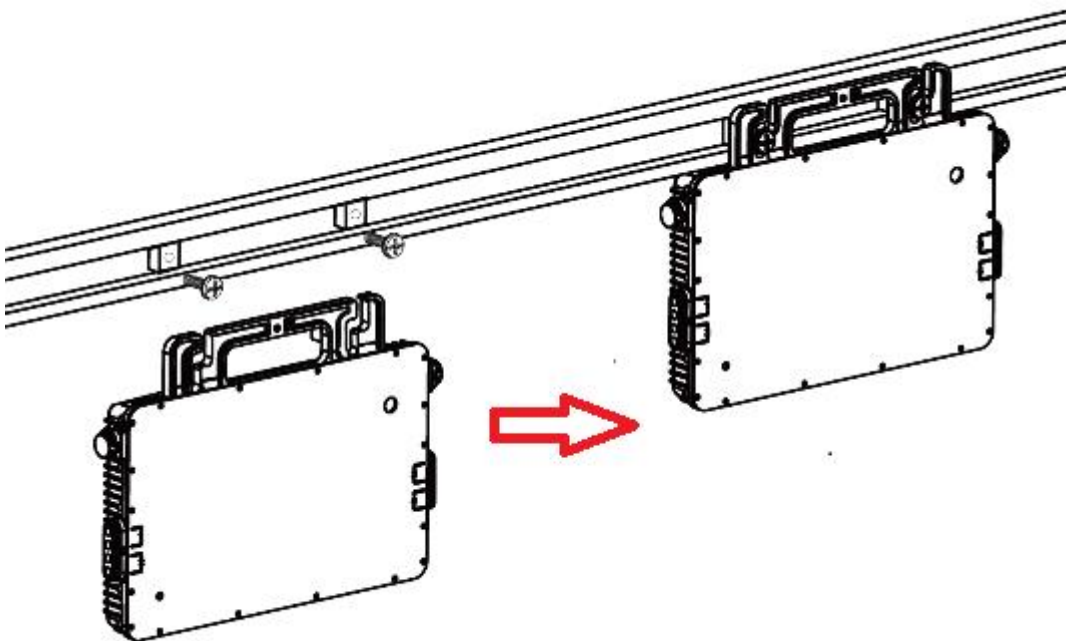

4.5.2 Step 2. Connect AC Cables of Microinverter

A). Plug the AC connector of the first microinverter into the connector of the second microinverter to form a continuous AC branch circuit.

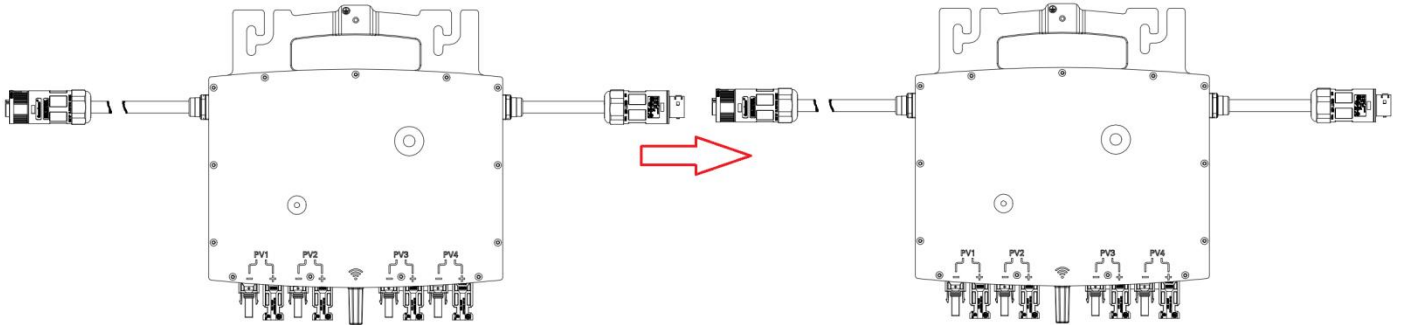

B). Install the AC end cap on the open AC connector.

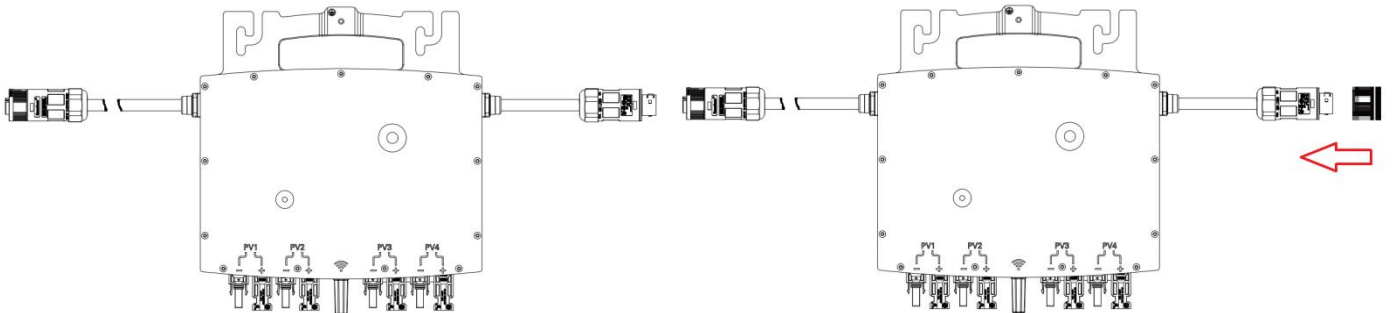

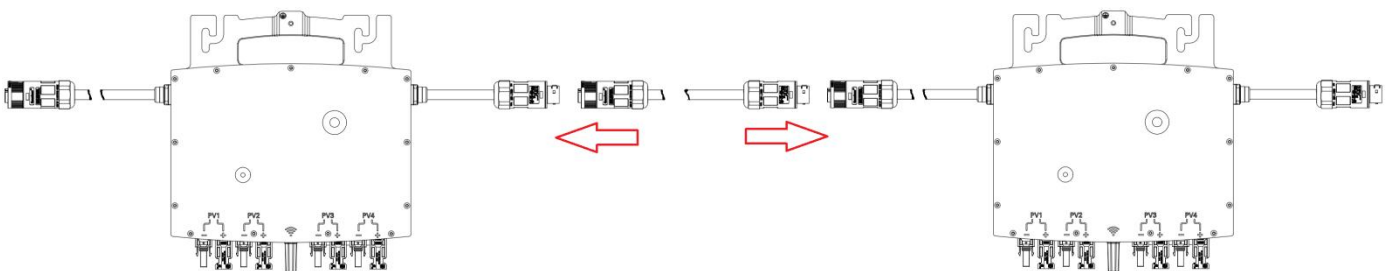

****Note: The length of AC cable on microinverter is roughly 2 m, if the distance between two microinverters is more than 2m, please use an AC extension cable between two microinverters (as shown in the picture below).***

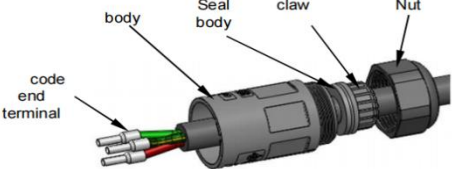
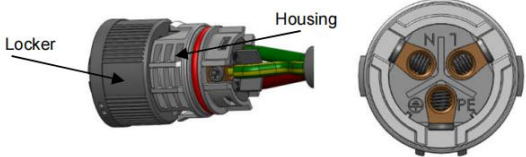

4.5.3 Step 3. Connect AC End Cable

A) Installation of cable end connector.

<p>Solid wrench No.30 or monkey wrench wide than 3cm、 Cross screwdriver No.1、 Wire striper.</p>	
<p>a). Disassemble the connector and thread the cable through the waterproof cap and connector housing</p>	
<p>b).Connect the cable to the terminal, and the screw torque is $0.8 \pm 0.1 \text{ N} \cdot \text{m}$</p>	
<p>c). Push Housing into Body</p>	
<p>d). Insert Seal and Clamp Finger into body, then tighten the nut, torque $2.5 \pm 0.5 \text{ N} \cdot \text{m}$</p>	
<p>e). Installation of cable end male connector is the same as female connector</p>	

Note: An electrical test should be done, to ensure that the connector has been installed correctly.

B) Connect the AC end cable with the AC branch circuit

<p>a).Mating male and female connector: Push the plug into the socket completely, then rotate the locker according to the direction instructed by the marks on the locker</p>	
---	--

4.5.4 Step 4. Create an Installation Map

Affix the serial number label to the respective location on the installation map.

HERF		Microinverter Installation Map										V1.0				
Please Make N for North 		Panel Type: Azimuth: Tilt: Sheet ___ of ___:					Customer Information:					DCU Serial Number:				
	1	2	3	4	5	6	7	8	9	10	1	12	13	14	15	16
A																
B																
C																
D																
E																
F																

4.5.5 Step 5. Connect PV Modules

A) Mount the PV modules above the microinverter.

B) Connect the PV modules' DC cables to the DC input side of the microinverter.

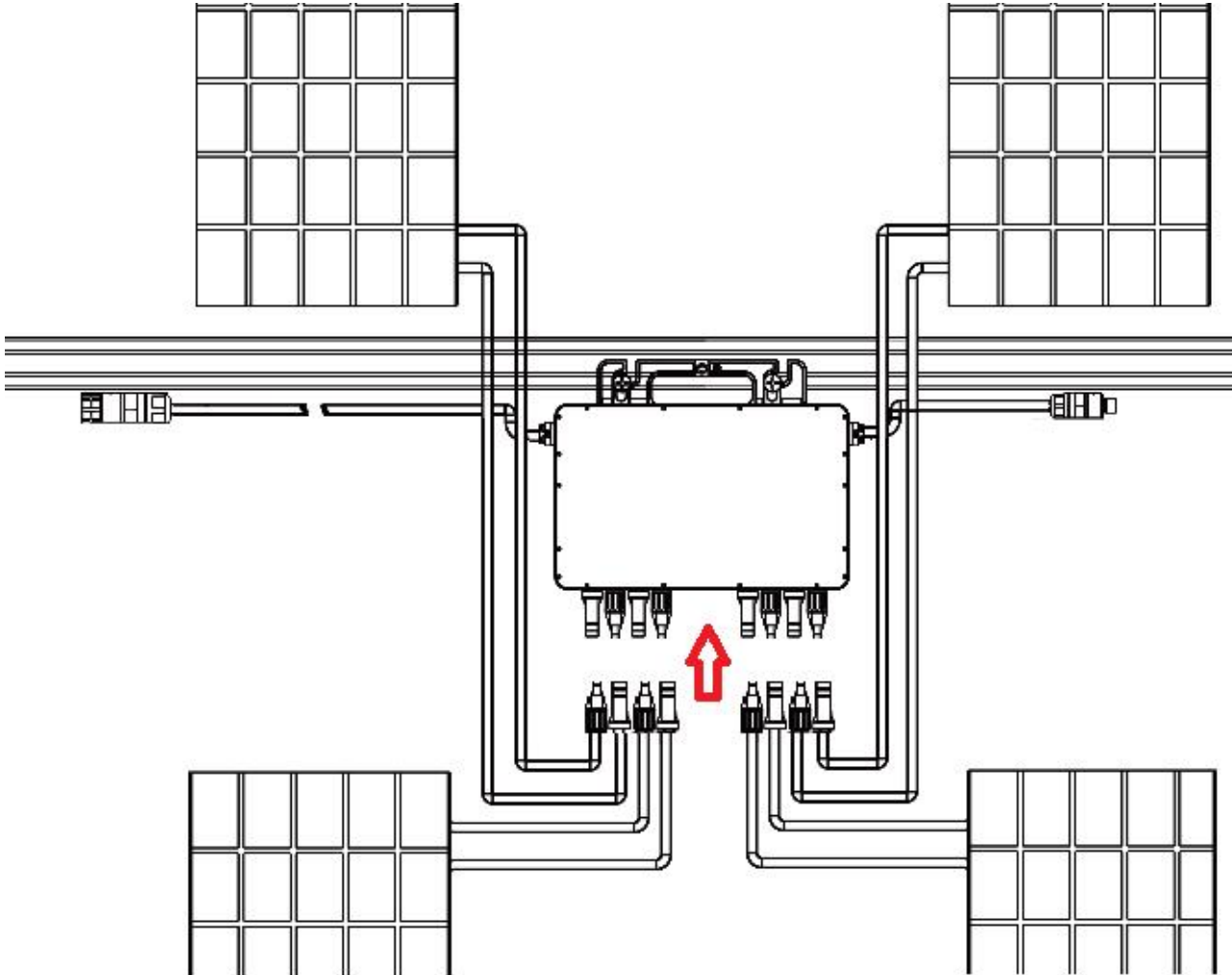

4.5.6 Step 6. Energize the System

A) Turn on the AC breaker of the branch circuit.

B) Turn on the main AC breaker of the house. Your system will start to generate power after about two minutes of waiting time.

4.5.7 Step 7. Set Up the Monitoring System

Refer to the DCU User Manual or DCU Quick Installation Guide, and Quick Installation Guide for S-Miles Cloud (HERF Monitoring Platform) Online Registration to install the DCU and set up your monitoring system.

5. Troubleshooting

5.1 Status LED Indicator

The LED flashes five times at start up. All green flashes (1s gap) indicate normal start up.

1.Start-up Process

- Flashing green five times (0.3s gap): Start-up success
- Flashing Red five times (0.3s gap): Start-up failure

2.Run Process

- Flashing Fast Green (1s gap): Producing power.
- Flashing Slow Green (2s gap): Producing power but one input is abnormal.
- Flashing Red (0.5s gap): There is a fault that are not invalid AC grid or hardware failure, refer to HERF Monitoring Platform for more details.
- Flashing Red (1s gap): Not producing power due to invalid AC grid.
- Solid Red: Hardware failure, refer to HERF Monitoring Platform for more details.

3.Other Status

- Flashing Red and Green alternately: Firmware is corrupted.

****Note: All the faults are reported to the DCU, refer to the local APP of the DCU or HERF Monitoring Platform for more information.***

5.2 On-site Inspection (For qualified installer only)

To troubleshoot an inoperable microinverter, follow the steps in the order shown.

1.Verify the utility voltage and frequency are within ranges shown in the in appendix Technical Data of this microinverter.

2.Check the connection to the utility grid. Verify utility power is present at the inverter in question by removing AC, then DC power. Never disconnect the DC wires while the microinverter is producing power. Re-connect the

DC module connectors and watch for five short LED flashes.

3. Check the AC branch circuit interconnection between all the microinverters. Verify each inverter is energized by the utility grid as described in the previous step.

4. Make sure that any AC breaker are functioning properly and are closed.

5. Check the DC connections between the microinverter and the PV module.

6. Verify the PV module DC voltage is within the allowable range shown in appendix Technical Data of this manual.

7. If the problem persists, please call HERF customer support.

****Note: Do not try to repair the microinverter. If the troubleshooting fails, please return it to the factory for replacement.***

5.3 Routine Maintenance

1. Only authorized personnel are allowed to carry out the maintenance operations and are responsible to report any anomalies.

2. Always use the personal protective equipment provided by the employer when carry out the maintenance operation.

3. During normal operation, check that the environmental and logistic conditions are correct. Make sure that the conditions have not changed over time and that the equipment is not exposed to adverse weather conditions and has not been covered with foreign bodies.

4. DO NOT use the equipment if any problems are found, and restore the normal conditions after the fault removed.

5. Conduct an annual inspection on various components, and clean the equipment with a vacuum cleaner or special brushes.

6. Decommissions

6.1 Decommissions

Disconnect the inverter from DC input and AC output; remove all connection cable from the Microinverter; remove the Microinverter from the frame.

Please pack the Microinverter with the original packaging, or use the carton box that can afford 5kg weight and can be fully closed if the original packaging is no longer available.

6.2 Storage and Transportation

HERF packages and protects individual components using suitable means to make the transport and subsequent handling easier. Transportation of the equipment, especially by road, must be carried out by suitable ways for protecting the components (in particular, the electronic components) from violent, shocks, humidity, vibration, etc. Please dispose the packaging elements in appropriate ways to avoid unforeseen injury.

It is the customer' s responsibility to examine the condition of the components transported. Once receiving the Microinverter, it is necessary to check the container for any external damage and verify receipt of all items. Call the delivering carrier immediately if damage or shortage is detected. If inspection reveals damage to the inverter, contact the supplier, or authorized distributor for a repair/return determination and instructions regarding the process.

The microinverter storage temperature is -40-85°C.

6.3 Disposal

If the equipment is not used immediately or is stored for long periods, check that it is correctly packed. The

equipment must be stored in well-ventilated indoor areas that do not have characteristics that might damage the components of the equipment.

Take a complete inspection when restarting after a long time or prolonged stop.

Please dispose the equipment properly after scrapping, which are potentially harmful to the environment, in accordance with the regulations in force in the country of installation.

7. Technical Data

7.1 DC Input

Model	HERF-1200	HERF-1600	HERF-1800
Commonly used module power (W)	Up to 420+ (Single panel)	Up to 540+ (Single panel)	Up to 670+ (Single panel)
Peak power MPPT voltage range (V)	16~48	16~48	16~48
Start-up voltage (V)	22	22	22
Operating voltage range (V)	16~60	16~60	16~60
Maximum input voltage (V)	60	60	60
Maximum input current (A)	4*13	4*13.5	4*14
Maximum input short circuit current (A)	4*20	4*20	4*20
Maximum Backfeed current(A)	0	0	0
Overvoltage category	II		

7.2 AC Output

Model	HERF-1200	HERF-1600	HERF-1800
Rated output power (W)	1200	1600	1800
Rated output current (A)	5.22	6.96	7.83
Nominal output voltage/range (V)	230/180-270	230/180-270	230/180-270
Nominal frequency/range (Hz)	45-55 (under 50Hz @ 220V & 230V)		
Power factor	>0.99		
Output current harmonic distortion	<3%	<3%	<3%
Maximum units per branch	6	4	4
Inrush Current (A/ μ s)	11.6		
Overvoltage category	III		
Protective Class	I		
Maximum Output fault current (A)	17.4	15.1	12.3
Max.output overcurrent protection (A)	20		

7.3 Efficiency, Safety and Protection

Model	HERF-1200	HERF-1600	HERF-1800
CEC peak efficiency	96.50%	96.50%	96.50%
Nominal MPPT efficiency	99.50%	99.50%	99.50%
Night time power consumption (mW)	<50	<50	<50

7.4 Mechanical Data

Model	HERF-1200	HERF-1600	HERF-1800
Ambient temperature range (°C)	-40 ~ +65	-40 ~ +65	-40 ~ +65
Storage temperature range (°C)	-40 ~ +85	-40 ~ +85	-40 ~ +85
Altitude (m)	2000		
Ambient humidity range (%)	4-100%		
Pollution degree	3		
Dimensions (W×H×D mm)	275*204.5*41.6		
Weight (kg)	4.9	4.9	4.9
Enclosure rating	Outdoor-NEMA (IP67)		
Cooling	Natural convection – No fans		

7.5 Features

Model	HERF-1200	HERF-1600	HERF-1800
Communication	Wireless_2.4G		
Monitoring	HERF Monitoring System (HERF DCU is required)		
Warranty	12 years standard, 25 years optional		
Compliance	EN 50549-1: 2019, VDE-R-N 4105: 2018		

****Note: Voltage and frequency ranges can be extended beyond nominal if required by the utility.***

Appendix 1:

Installation Map

HERF		Microinverter Installation Map											V1.0				
Please Make N for North 		Panel Type: Azimuth: Tilt: Sheet ___ of ___:						Customer Information:						DCU Serial Number:			
	1	2	3	4	5	6	7	8	9	10	11	12	13	14	15	16	
A																	
B																	
C																	
D																	
E																	
F																	

Appendix 2:

WIRING DIAGRAM – 230VAC SINGLE PHASE:

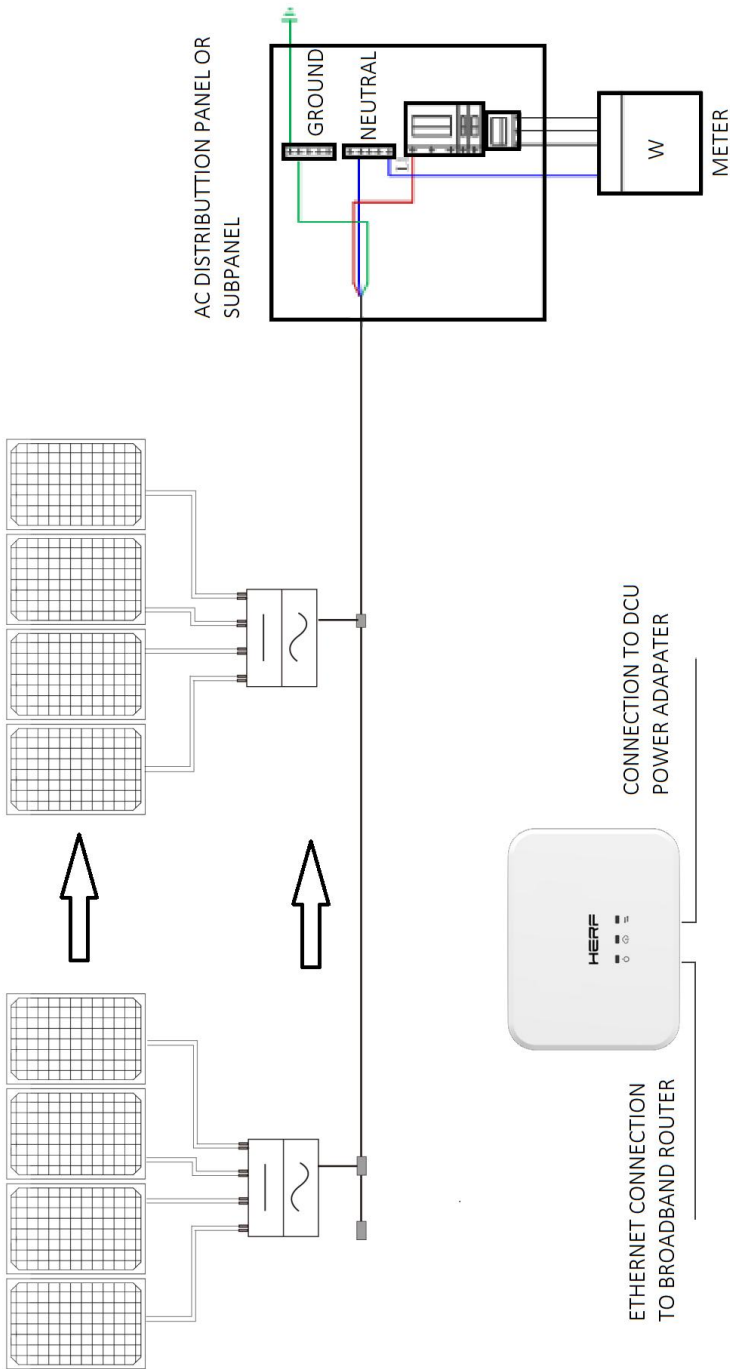

WIRING DIAGRAM – 230VAC / 400VAC THREE PHASE:

