

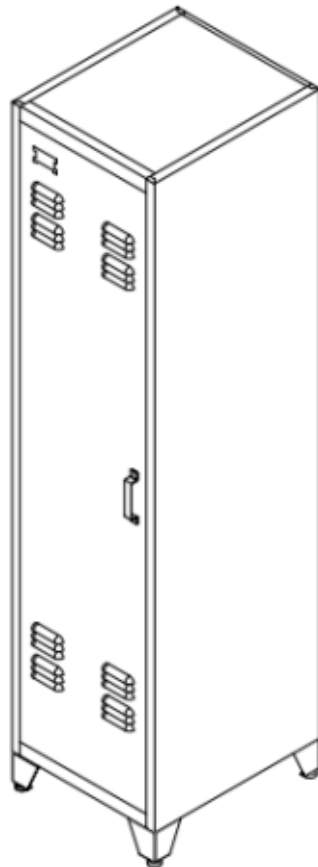

STAHLCHRANK PETROW

Artikel-Nr.: 12238, 12239, 12240

- AUFBAUANLEITUNG -



Installationsvideos und Aufbauanleitungen
zu unseren Produkten finden Sie unter

www.jet-line.de







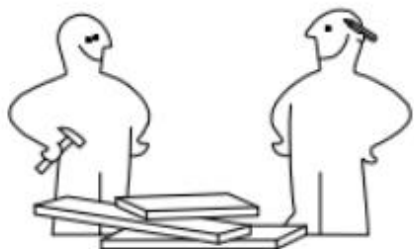
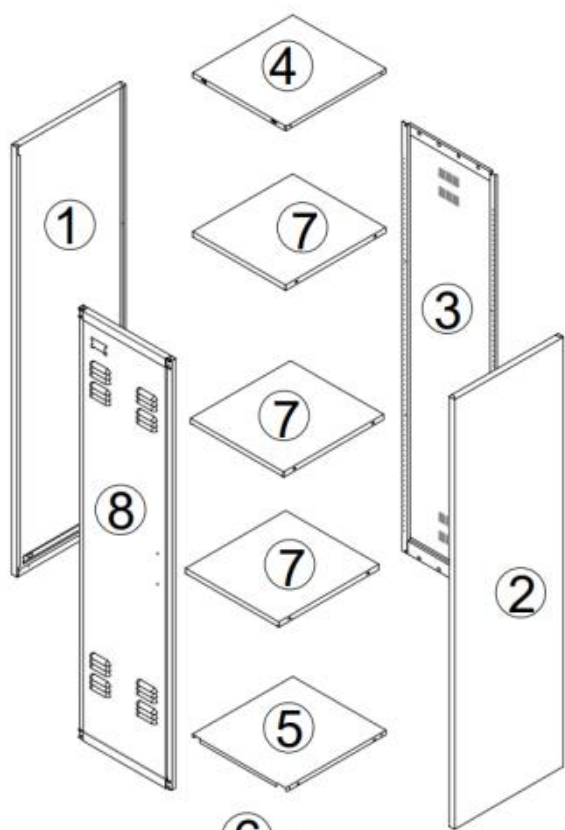

Nutzername: jet-line • Passwort: user2011

Weitere Produkte für Ihr Büro
finden Sie unter

www.jet-line.de

Teile-Liste:



| | | |
|---|--|-----|
| 1 | Seitenwand links | 1x |
| 2 | Seitenwand rechts | 1x |
| 3 | Rückwand | 1x |
| 4 | Obere Abdeckung | 1x |
| 5 | Boden | 1x |
| 6 | Füße | 4x |
| 7 | Zwischenboden | 3x |
| 8 | Front | 1x |
| A | Schraube M5x10   | 29x |
| B | Schraube M5x10   | 2x |
| C | Mutter M5  | 2x |
| D | Clip  | 12x |
| E | Griff  | 1x |
| F | Verbinder  | 2x |

Aufbauanleitung:

SCHRITT 2

SCHRITT 1

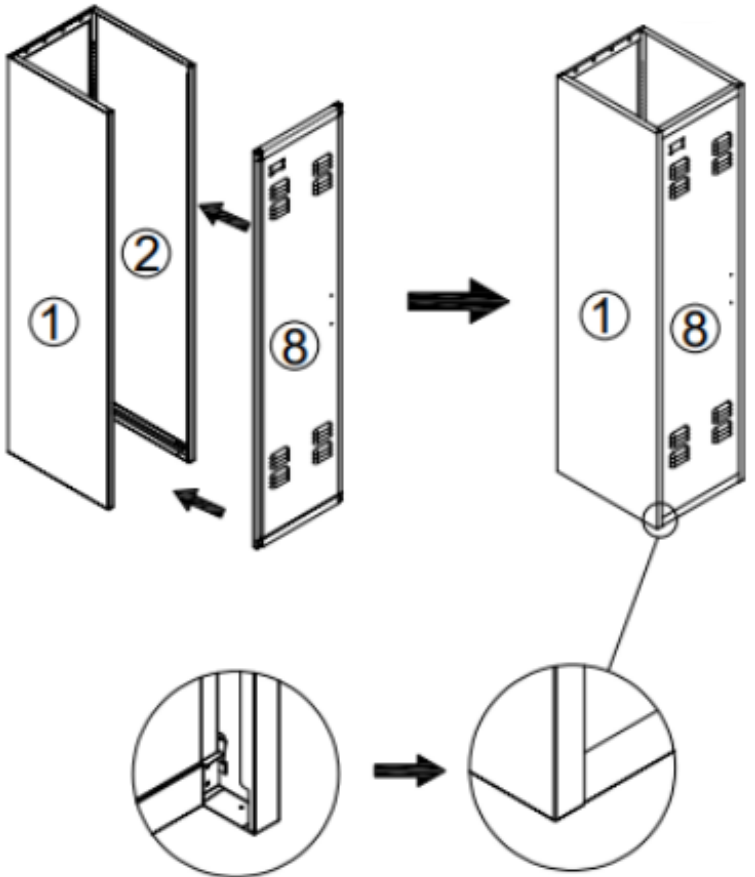
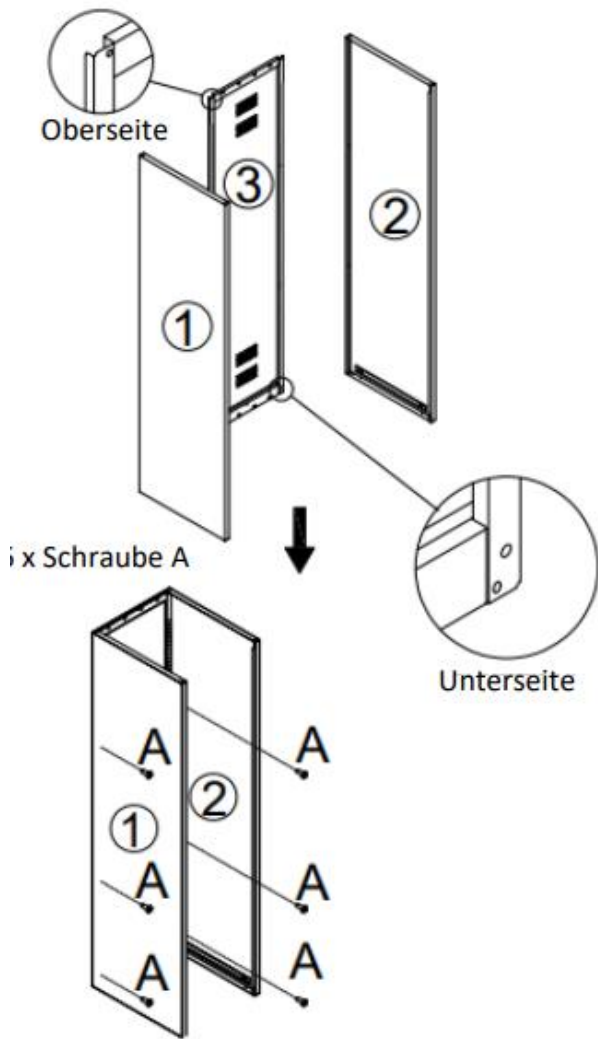

SCHRITT 3

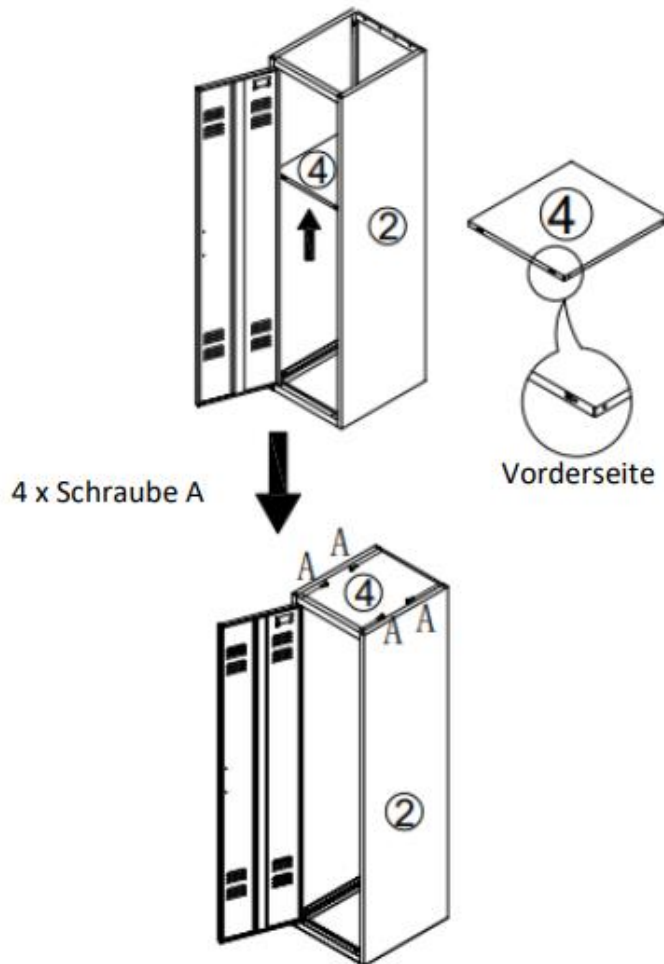

SCHRITT 4

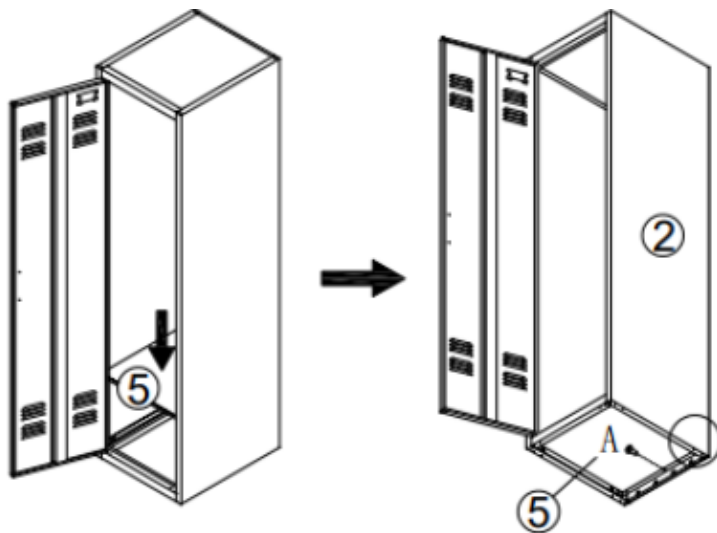

1 x Schraube A

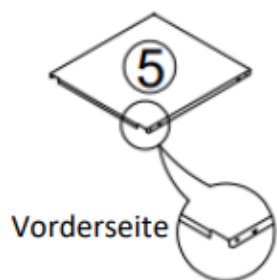

Vorderseite

SCHRITT 6

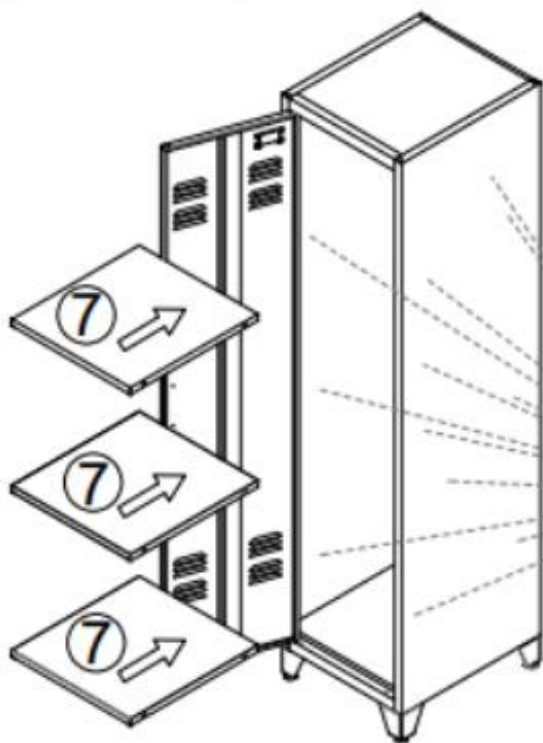

12 x Clip D

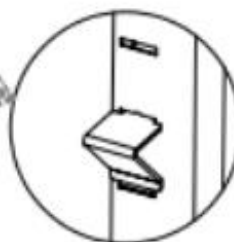

Maximalgewicht pro Regalboden: 40 kg

SCHRITT 5

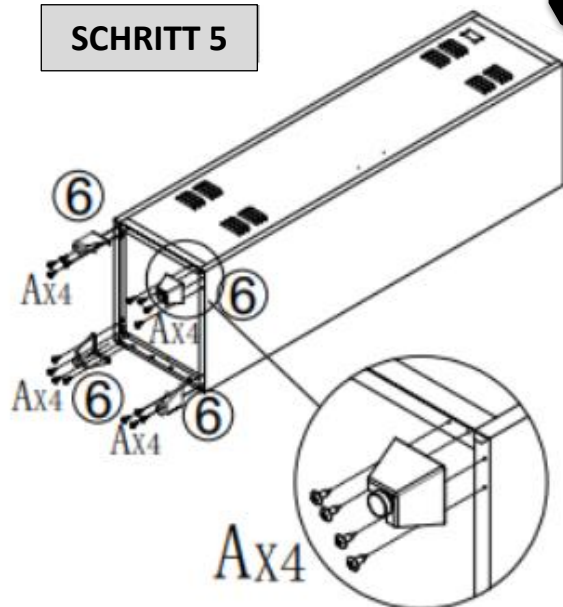

16 x Schraube A

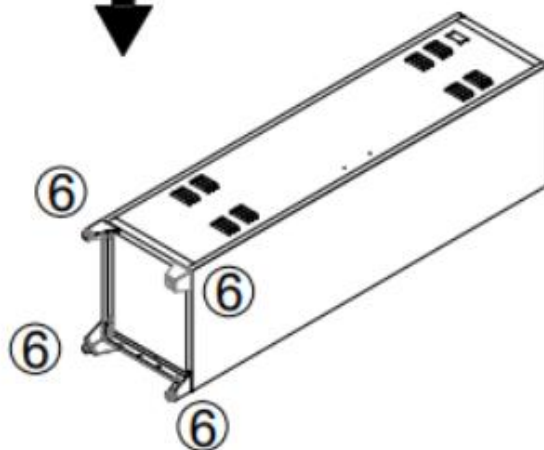

SCHRITT 7

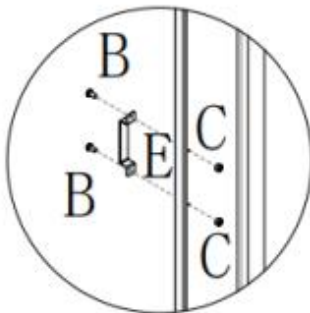
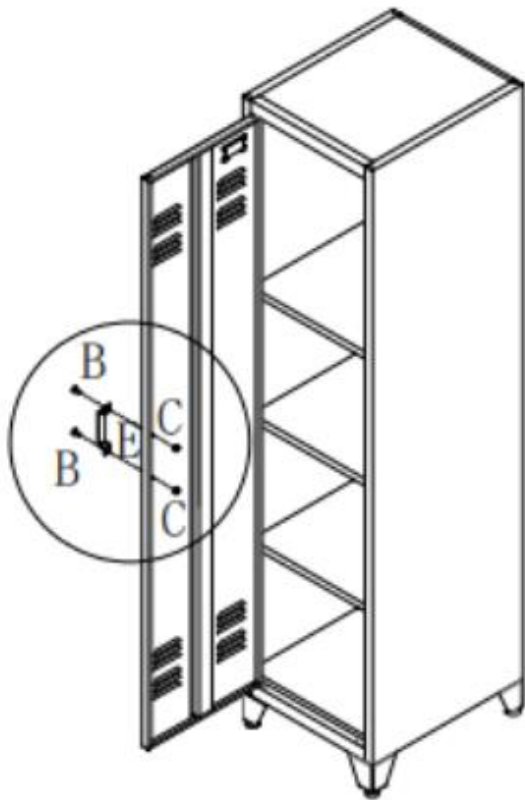

2 x Schraube B
2 x Mutter C
1 x Griff

SCHRITT 8

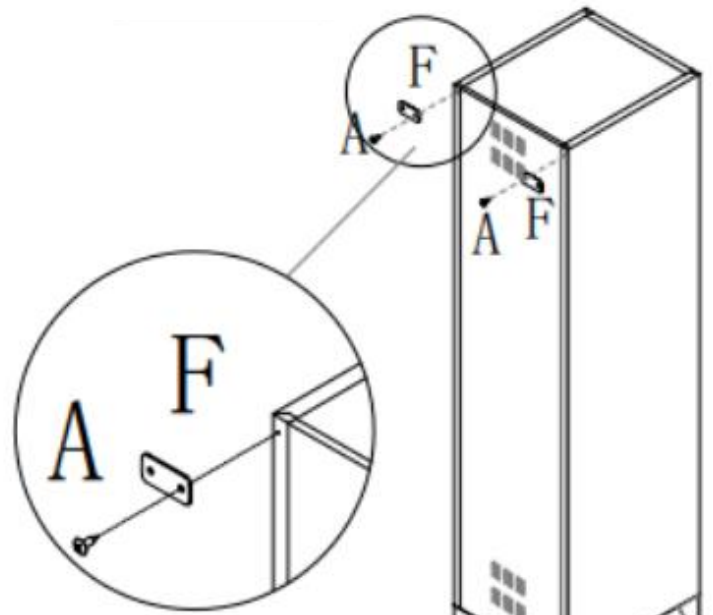

2 x Schraube A
2 x Verbinder F



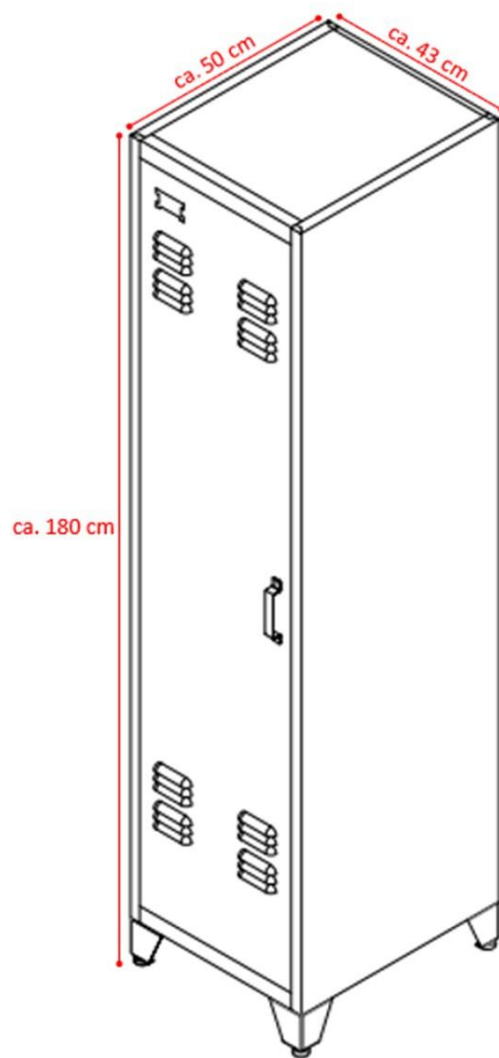

Installationsvideos und Aufbauanleitungen

zu unseren Produkten finden Sie unter

www.jet-line.de

Nutzername: jet-line • Passwort: user2011

Weitere Produkte für Ihr Büro

finden Sie unter

www.jet-line.de



KBW Trading GmbH
Gewerbering 2
88518 Herbertingen
Deutschland
Tel: 07586-921160
Fax: 07586-9211616
E-Mail: info@jet-line.de
www.office-shopping.eu