

Massage Bathtub

Instructions of Installation and Use



MT-RT1701
MT-RT1801
MT-RT1901

Dear Customer,
Thank you for choosing our product. For your safe concern, please take a few minutes to read this manual before installation and use.

WARNING

1. For a person who has heart trouble, high blood pressure & sugar diabetes should not take a steam shower or bath when feeling sick. (The kid is suggested to be accompanied by an adult when taking a bath)
2. Don't take a bath alone after drinking wine with alcohol or excess sports.
3. The water temperature should be below 45°C during shower and the recommended temperature is 30°C-38°C.
4. Don't take a bath for a long time. Recommended time: 15-21minutes.
5. All the information in this instruction are subject to change without prior notice.
6. Settings, configurations and details of the products are subject to be changed or upgraded without prior notice.
7. For the maintenance, please contact the technicians appointed by the dealer and don't disassemble and fix by yourself, or the supplier will be free from any consequences that may occur.

CONTENTS:

Preparations _____ Page2
 Installation Process _____ Page6
 Instruction of Using Our Products _____ Page9

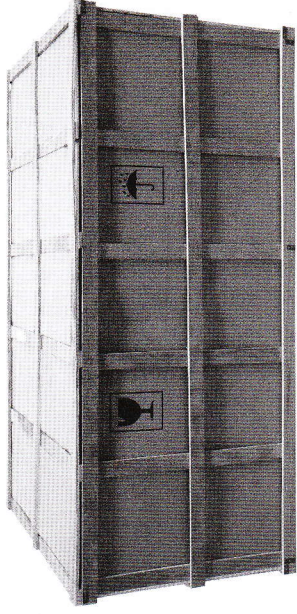

Please make sure all accessories are in the package
(Bathtub 1set Accessory box 1pcs)

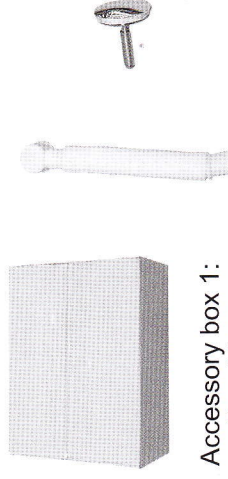

Accessory box 1:
Faucet 1 pcs

Installation Tools:(no included)

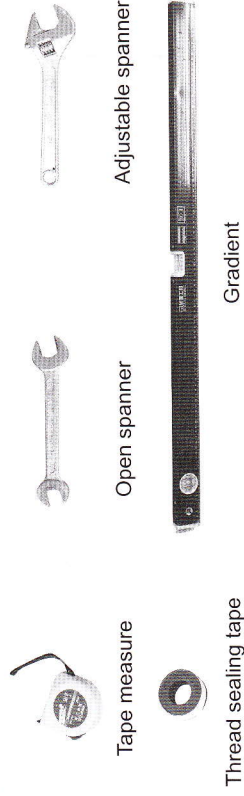

Tape measure

Open spanner

Adjustable spanner

Thread sealing tape

Gradient

MODEL: MT-RT1701-b
 SIZE: 1700mmX750mmX610mm
 MODEL: MT-RT1801-b
 SIZE: 1800mmX800mmX610mm
 MODEL: MT-RT1901-b
 SIZE: 1950mmX900mmX610mm

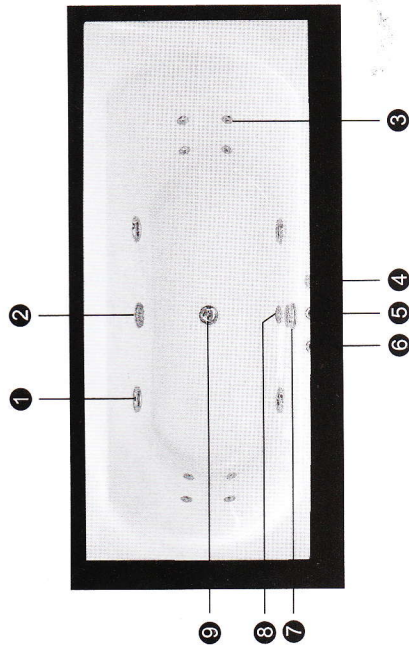

- 1 Big Water Jets
- 2 Water Circulation
- 3 Small Jets
- 4 Volume Control
- 5 Light Switch
- 6 Surfing Switch
- 7 Drainer Switch
- 8 Light
- 9 Drainer

MODEL: MT-RT1701-c
 SIZE: 1700mmX750mmX610mm
 MODEL: MT-RT1801-c
 SIZE: 1800mmX800mmX610mm
 MODEL: MT-RT1901-c
 SIZE: 1950mmX900mmX610mm

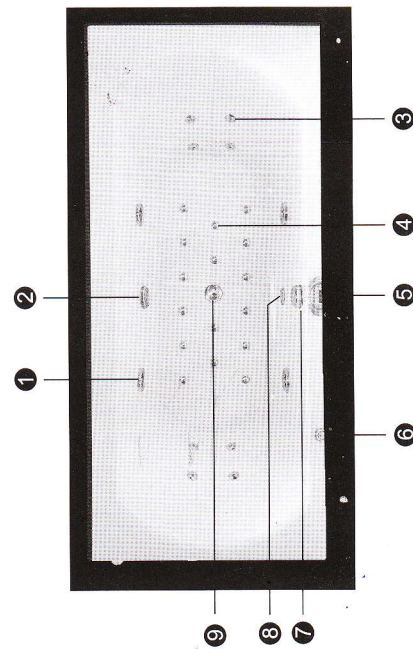

- 1 Big Water Jets
- 2 Water Circulation
- 3 Small Jets
- 4 Air Jets
- 5 Control Panel
- 6 Volume Control
- 7 Drainer Switch
- 8 Light
- 9 Drainer

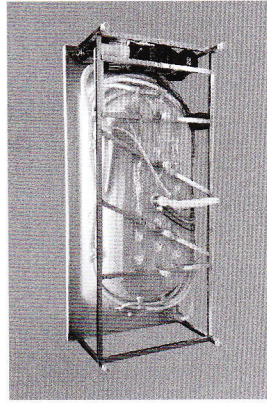

1. Side up the bathtub, then install downcomer



2. Use thread sealing tape to wrap around the drain hole



3. Make the thread sealing tape smooth

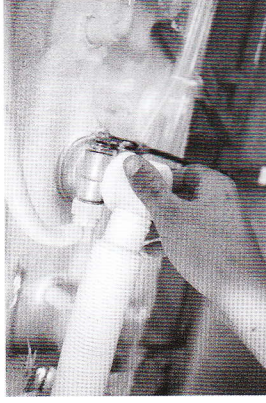

4. Fasten the drain tube



5. Put downcomer into the drain hole on the ground



6. Put plugs into the drain hole

7. Seal the bathtub's edge with silica gel as follows

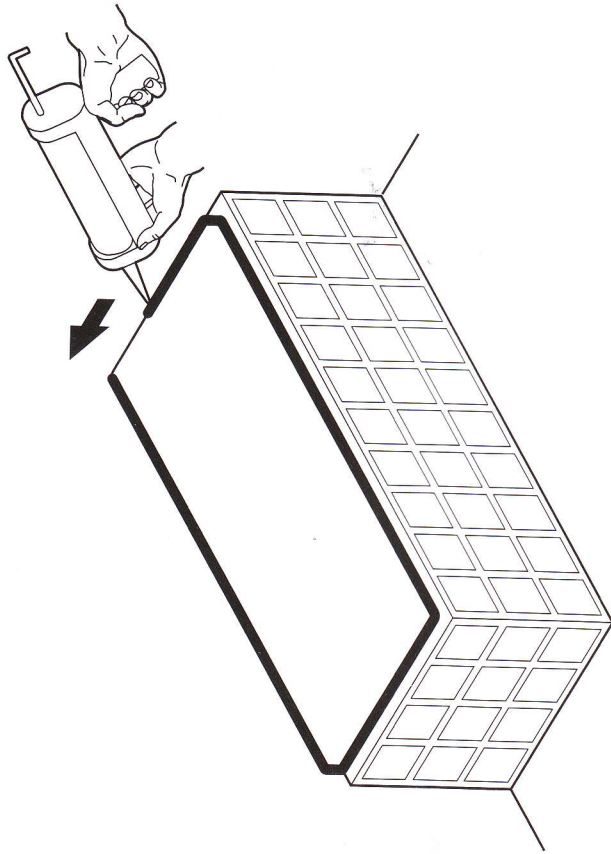

Unique Point:

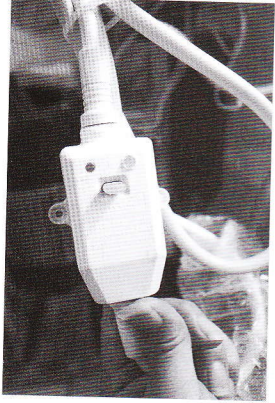

1. The creepage protector will automatically cut off the circuit if the current is too high.



2. Stereo speaker Leakage protector

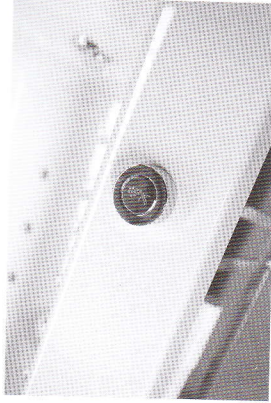

3. Volume Control

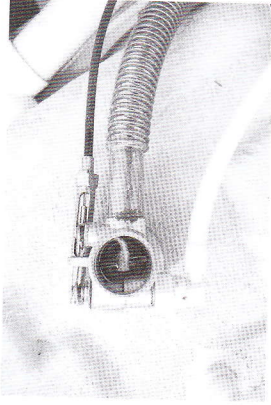

4. Waste water piping system

VI. TECHNICAL DATA



1. Voltage: AC220V ± 10%, 50Hz
AC110V ± 10%, 60Hz
2. Power: 3500W
3. Dielectric Strength: 1500V, 1min
4. Lighting Load: AC12V, 20W
5. Music Power: ≤ 15W
6. Frequency Range: FM88-108MHz
7. S/N Radio: ≥ 45dB
8. AIR PUMP: AC220V50Hz ≤ 1kW
9. HEAT POWER: AC220V50Hz ≤ 1.5kW
10. Ozone: AC12V ≤ 20W
11. WATER PUMP: POWER ≤ 1kW

VII. OPERATION MANUAL

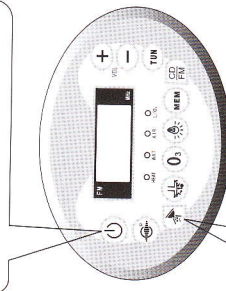

Power on/off
Please Press ()Key



1. Power:

Surfing Operation: Connect the creepage protector, press (), the system starts to work, LCD screen shows the actual temperature. At this moment, you can select the functions desired; Press () to turn off the system.

(1). Water Pump:

Press (), the pump is turned on, and the LED indicator is on correspondingly; press again () to turn off the pump; (Notice: When there is not sufficient water in the tub, the system will shut off the pump and the indicator will flash until the water level reaches the standard)

● HEAT L/O, ● WAT AIR

(1). Water Pump
Please Press ()Key

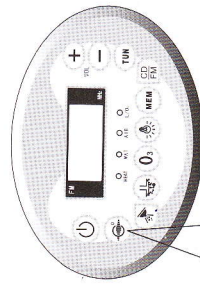

(2). Heater:

The water pump has to be activated before using the heater. The computer establishes (45℃). Press again ()key, heat function to OFF.

● HEAT L/O, ● WAT AIR

(2). Heater
Please Press ()Key

(3). Bubble Bath:

Press this button () on the panel to switch on/off bubble bath function and the indicator related will be on/off accordingly.

● HEAT L/O, ● WAT AIR

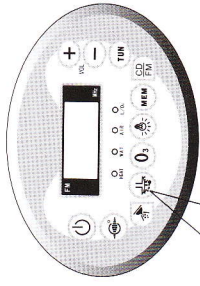

(3). Bubble Bath
Please Press ()Key

(4). Ozonation:

Press () to turn on/off this function and the indicator related will be on/off accordingly.

(Remarks: each time the ozonator works for 10 minutes, after 10 minutes, the system shut it off automatically.)

● HEAT L/O, ● WAT AIR

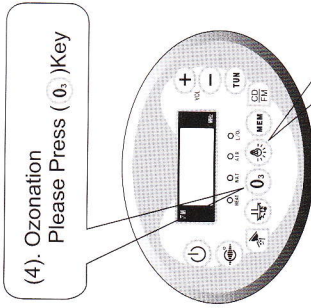

(4). Ozonation
Please Press ()Key

(5). Underwater Light:

Press () to turn on/off the light and the indicator will be on/off accordingly.

● HEAT L/O, ● WAT AIR



(5). Underwater Light
Please Press ()Key

(6). Temperature Setting:





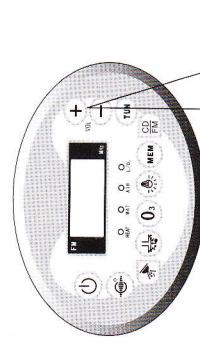



Press the (VOL) button to set the water temperature in the tub, the setting ranges: (20℃-50℃). Press (VOL+) to increase the preset temperature, press (VOL-) to decrease the temperature and the screen shows accordingly.

(Remarks: For this function, FM & DC should be turned off first, otherwise, it is for volume adjustment) Preset Temperature by factory: 45℃



(6). Temperature Setting
Please Press The (VOL)Key



2. FM Function:

- (1). Pull out the antenna and set it as Y type, press , the screen shows FM frequency, the volume indicating as DB increases to "00dB" from "03dB".
- (2). Press  key to upward tuning, interval press is for manual selecting. If the key is held for over 2 seconds, the frequency will stop at the channel the digital founds.(Notice: You can press  key for upward and press  key for downward. In the case of the weak signal, manual selecting is suggested.) Press  key when a channel is selected, the screen will show "P-***" , and the channel will be memorized.(Notice: The "*" of the "P-***" is positioned memory number, the capacity of memory is 10.) If the received signal is weak, unfold the antenna and readjust. Press  key to select the channel you like after setting.
- (3). Volume Control: Press the volume  or  to adjust the volume, the correspondent DB will be indicated in the screen.

3. External CD:

Connect the CD audio wire with the external socket of the main control box, press CD/RADIO for CD function, then choose the desired volume by pressing (VOL+) or (VOL-).

4. Key Description:

- (1). It is the store function after pressing  or after station selection; and direct pressing of the  key is selecting the channels that have been memorized.
- (2). (VOL+) and (VOL-) Function: it is for temperature adjustment when the radio and CD functions are ineffective, while the radio or CD functions is effective, it is for volume adjustment; when the radio function is effective, press , it is for station selection.
- (3). It is for tuning upward function, and also the station searching function by pressing (VOL+) or (VOL-).

VIII. PRECAUTIONS:

1. The installation should be carried out by a qualified technician and creepage protector should be installed in the place easily to be controlled.
2. The electronic parts should be well grounded, otherwise, the manufacturer will not be liable for any loss or consequences occurred.
3. The load capability of the power supply should be considered during installation, or it affects the normal operation of the product or may lead to accident!
4. For any functions can not be activated through the ways mentioned above, please contact a certified technicians or local dealer.
5. If you don't use the product for a long time, please disconnect the main power supply.
6. Parts containing live parts, except parts supplied with safety extra-low voltage not exceeding 12V, must be inaccessible to a person in the bath.
7. Earthed appliances must be permanently connected to fixed wiring.
8. Parts incorporating electrical components, except remote control devices, must be located or fixed so that they cannot fall into the bath.
9. The appliance should be supplied through a residual current device (RCD) having a rated residual operating current not exceeding 30mA.
10. Make sure that the wire is laid correctly.
11. Make sure that the equipotential connection is done correctly.
12. The means having a contact at least 3.0mm separation in all poles that provide full disconnection must be incorporated in the fixed wiring in accordance with the wiring rules.
13. If the supply cord is damaged, it must be replaced by the manufacturer, its service agent or similarly qualified persons in order to avoid a hazard.



Earthing Marking



Equipotential



Switch Marking

Cleaning&Maintenance

1. During the transportation or installation, do not pull the pipe or hold accessories to avoid the water leakage.
2. After long time use, if there are some dirt on product's surface, wipe it off gently by a soft towel stained with mild detergent; for the metal parts, polish it with some car wax by a towel, which brings out a refreshing appearance.
3. Scale deposit can be wiped off with warm citric acid or vinegar by a soft cloth.
4. Don't clean the tub and accessories with hard or coarse material to avoid any scratches.
5. Don't clean the tub and accessories with gasoline to avoid any damages.
6. It is not recommended to leave water in the tub for a long time or use this tub for washing purpose. Pls drain off the water after the bath and disconnect the power supply.
7. There should be sufficient power supply and wires should be safely grounded.
8. For your safety, a professional technician is necessary to ensure earthing wire be well grounded and a RCCB fitted during installation.